



PRODUCT MANUAL

Dynamic C[®]

Integrated C Development System
For Rabbit[®] 4000, 5000 and 6000 Microprocessors

User's Manual

019-0167_E

The latest revision of this manual is available on the Rabbit Web site,
www.rabbit.com.

Dynamic C User's Manual

Part Number 019-0167 • Printed in the U.S.A.
Digi International Inc. © 2010 • All rights reserved.

Digi International Inc. reserves the right to make changes and improvements to its products without providing notice.

Trademarks

Rabbit[®] and Dynamic C[®] are registered trademarks of Digi International Inc.

Windows[®] is a registered trademark of Microsoft Corporation

TABLE OF CONTENTS

1. Installing Dynamic C	
1.1 Requirements.....	8
1.2 Assumptions	8
2. Introduction to Dynamic C	
2.1 The Nature of Dynamic C	9
2.1.1 Speed	9
2.2 New Features from ANSI C.....	10
2.3 Dynamic C Enhancements and Differences.....	10
3. Quick Tutorial	
3.1 Run DEMO1.C.....	13
3.1.1 Single Stepping	14
3.1.2 Watch Expression	14
3.1.3 Breakpoint	14
3.1.4 Editing the Program	15
3.2 Run DEMO2.C.....	15
3.2.1 Watching Variables Dynamically	15
3.3 Run DEMO3.C.....	16
3.3.1 Cooperative Multitasking	16
3.4 Summary of Features	17
4. Language	
4.1 Storage Classes	19
4.2 Pointers.....	19
4.3 Far Pointers and Far Data.....	20
4.3.1 The far Qualifier	20
4.3.2 Basic Declarations	20
4.3.3 Multi-Level Far Pointers	21
4.3.4 Arrays and Structures	21
4.3.5 Complex Declarations	22
4.3.6 Sample Programs	22
4.4 The const Keyword.....	23
4.4.1 Simple Constants	23
4.4.2 Const and Pointers	23
4.4.3 Const Conversions, Casting, and Parameter Passing	25
4.4.4 Dynamic C Version Differences	28
4.5 Pointers to Functions, Indirect Calls.....	29
4.6 Function Chaining	31
4.7 Global Initialization	32
4.8 Libraries	33
4.8.1 Libraries and File Scope	34
4.8.2 LIB.DIR	35
4.9 Headers.....	36
4.10 Modules	36
4.10.1 The Parts of a Module	36
4.10.2 Module Sample Code	38
4.10.3 Important Notes	39
4.11 Function Description Headers.....	40
4.12 Support Files	40
5. Multitasking with Dynamic C	
5.1 Cooperative Multitasking.....	41
5.2 A Real-Time Problem.....	42
5.2.1 Solving the Real-Time Problem with a State Machine	43
5.3 Costatements	43
5.3.1 Solving the Real-Time Problem with Costatements	44
5.3.2 Costatement Syntax	44
5.3.3 Control Statements	45
5.4 Advanced Costatement Topics.....	47
5.4.1 The CoData Structure	47
5.4.2 CoData Fields	48
5.4.3 Pointer to CoData Structure	49
5.4.4 Functions for Use With Named Costatements	49
5.4.5 Firsttime Functions	50
5.4.6 Shared Global Variables	50
5.5 Cofunctions	50
5.5.1 Cofunction Syntax	51
5.5.2 Calling Restrictions	51
5.5.3 CoData Structure	52
5.5.4 Firsttime Functions	52

5.5.5	Types of Cofunctions	53	6.5	Reference to Other Debugging Information	99
5.5.6	Types of Cofunction Calls	54	7. The Virtual Driver		
5.5.7	Special Code Blocks	55	7.1	Default Operation	100
5.5.8	Solving the Real-Time Problem with Cofunctions	56	7.2	Calling <code>_GLOBAL_INIT()</code>	100
5.6	Patterns of Cooperative Multitasking	56	7.3	Global Timer Variables	101
5.7	Timing Considerations	57	7.3.1	Example: Timing Loop	101
5.7.1	waitfor Accuracy Limits	57	7.3.2	Example: Delay Loop	102
5.8	Overview of Preemptive Multitasking	58	7.4	Watchdog Timers	103
5.9	Slice Statements	58	7.4.1	Hardware Watchdog	103
5.9.1	Slice Syntax	58	7.4.2	Virtual Watchdogs	103
5.9.2	Usage	59	7.5	Preemptive Multitasking Drivers	103
5.9.3	Restrictions	59	8. The Slave Port Driver		
5.9.4	Slice Data Structure	59	8.1	Slave Port Driver Protocol	104
5.9.5	Slice Internals	59	8.1.1	Overview	104
5.10	μ C/OS-II	61	8.1.2	Registers on the Slave	105
5.10.1	Changes to μ C/OS-II	62	8.1.3	Polling and Interrupts	106
5.10.2	Tasking Aware Interrupt Service Routines (TA-ISR)	64	8.1.4	Communication Channels	106
5.10.3	Library Reentrancy	70	8.2	Functions	107
5.10.4	How to Get a μ C/OS-II Application Running	70	8.3	Examples	111
5.10.5	Compatibility with TCP/IP	75	8.3.1	Status Handler	111
5.10.6	Debugging Tips	76	8.3.2	Serial Port Handler	111
5.11	Summary	76	8.3.3	Byte Stream Handler	123
6. Debugging with Dynamic C			9. Run-Time Errors		
6.1	Debugging Features of Dynamic C	77	9.1	Run-Time Error Handling	131
6.2	Debugging Tools	79	9.1.1	Error Code Ranges	131
6.2.1	<code>printf()</code>	79	9.1.2	Fatal Error Codes	132
6.2.2	ANSI Escape Sequences	80	9.2	User-Defined Error Handler	133
6.2.3	Software Breakpoints	81	9.2.1	Replacing the Default Handler	133
6.2.4	Hardware Breakpoints	82	9.3	Run-Time Error Logging	134
6.2.5	Single Stepping	84	9.3.1	Error Log Buffer	134
6.2.6	Watch Expressions	85	9.3.2	Initialization and Defaults	135
6.2.7	Evaluate Expressions	86	9.3.3	Configuration Macros	135
6.2.8	Memory Dump	86	9.3.4	Error Logging Functions	136
6.2.9	MAP File	87	9.3.5	Examples of Error Log Use	136
6.2.10	Symbolic Stack Trace	90	10. Memory Management		
6.2.11	Assert Macro	91	10.1	Memory Map	137
6.2.12	Miscellaneous Debugging Tools	91	10.1.1	Memory Mapping Control	138
6.3	Where to Look for Debugger Features	94	10.2	Extended Memory Functions	138
6.3.1	Run and Inspect Menus	95	10.3	Code Placement in Memory	138
6.3.2	Options Menu	95	10.4	Dynamic Memory Allocation	139
6.3.3	Window Menu	95			
6.4	Debug Strategies	96			
6.4.1	Good Programming Practices	96			
6.4.2	Finding the Bug	98			

11. Direct Memory Access

11.1 DMA Registers and Global Resources...	140
11.2 API Functions	140
11.3 DMA Interrupts	141
11.4 DMA Transfer Information.....	141
11.4.1 DMA Transfer Priority	141
11.4.2 DMA Transfer Mode	142
11.4.3 DMA Transfer Functions	142
11.4.4 DMA Transfer Function Flags	142
11.5 DMA with Ethernet.....	142

12. FAT File System

12.1 Overview of FAT Documentation	144
12.2 Running Your First FAT Sample Program	144
12.2.1 Bringing Up the File System	145
12.2.2 Using the File System	148
12.3 More Sample Programs	151
12.3.1 Blocking Sample	151
12.3.2 Non-Blocking Sample	153
12.4 FAT Operations	157
12.4.1 Format and Partition the Device	157
12.4.2 File and Directory Operations	159
12.5 More FAT Information.....	168
12.5.1 Clusters and Sectors	168
12.5.2 The Master Boot Record	168
12.5.3 FAT Partitions	169
12.5.4 Directory and File Names	172
12.5.5 μ C/OS-II and FAT Compatibility	172
12.5.6 SF1000 and FAT Compatibility	172
12.5.7 Hot-Swapping an xD Card	172
12.5.8 Hot-Swapping an SD Card	173
12.5.9 Unsupported FAT Features	173
12.5.10 References	174

13. Using Assembly Language

13.1 Mixing Assembly and C.....	175
13.1.1 Embedded Assembly Syntax	175
13.1.2 Embedded C Syntax	176
13.1.3 Setting Breakpoints in Assembly	176
13.1.4 Assembly and 32-bit Pointer Registers (PW, PX, PY, PZ)	177
13.2 Assembler and Preprocessor.....	178
13.2.1 Comments	178
13.2.2 Defining Constants	178
13.2.3 Multiline Macros	180
13.2.4 Labels	180

13.2.5 Special Symbols	181
13.2.6 C Variables	181
13.3 Stand-Alone Assembly Code	182
13.3.1 Stand-Alone Assembly Code in Extended Memory	183
13.3.2 Example of Stand-Alone Assembly Code	183
13.3.3 The Stack Frame	184
13.3.4 Embedded Assembly Example	185
13.3.5 The Disassembled Code Window	186
13.3.6 Local Variable Access	187
13.4 C Calling Assembly.....	189
13.4.1 Passing Parameters	189
13.4.2 Location of Return Results	190
13.4.3 Returning a Structure	190
13.5 Assembly Calling C.....	191
13.6 Interrupt Routines in Assembly	191
13.6.1 Steps Followed by an ISR	192
13.6.2 Modifying Interrupt Vectors	192
13.7 Common Problems.....	195

14. Keywords

abandon	196
abort.....	196
align.....	197
always_on.....	197
anymem	197
asm	198
auto	198
bbam.....	198
break.....	199
c	199
case.....	199
char.....	200
cofunc	200
const	201
continue.....	201
costate.....	201
debug	202
default.....	202
do.....	202
else.....	203
enum.....	203
extern.....	203
far	204
firsttime	207
float	207
for	208
goto.....	208
if	208
.init_on	209
int.....	209
interrupt.....	209
__lcall__.....	209
long.....	210
main.....	210
nodebug	210
norst.....	211

nouseix.....	211
NULL	211
protected	212
register	212
return	213
root.....	213
scofunc.....	213
segchain	214
shared.....	214
short.....	214
size.....	215
signed.....	215
sizeof	215
speed.....	215
static.....	216
struct	216
switch.....	217
typedef	217
union.....	218
unsigned.....	218
useix.....	218
waitfor	219
waitfordone	
(wfd)	219
while	220
xdata	220
xmem	221
void.....	221
volatile	222
xstring	222
yield.....	222
14.1 Compiler Directives	223
#asm.....	223
#class	223
#debug	
#nodebug	224
#define	224
#endasm.....	224
#error	224
#fatal.....	225
#funcchain	225
#GLOBAL_INIT	225
#if	
#elif	
#else	
#endif.....	226
#ifdef	226
#ifndef	227
#include	227
#interleave	
#nointerleave	227
#makechain.....	228
#mmap.....	228
#pragma.....	228
#undef.....	228
#use.....	229
#useix	
#nouseix.....	229
#warns	229
#warn.....	229
#ximport	230
#zimport.....	230

15. Operators

15.1 Arithmetic Operators	232
+	232
-.....	232
*.....	233
/.....	233
++.....	234
--.....	234
%	234
15.2 Assignment Operators	235
=	235
+=	235
-=	235
*=	235
/=	235
%=	235
<<=.....	235
>>=.....	235
&=.....	236
^=.....	236
=.....	236
15.3 Bitwise Operators.....	236
<<.....	236
>>.....	236
&.....	237
^.....	237
.....	237
~.....	237
15.4 Relational Operators	238
<	238
<=.....	238
>	238
>=.....	238
15.5 Equality Operators	239
==	239
!=	239
15.6 Logical Operators.....	240
&&.....	240
.....	240
!	240
15.7 Postfix Expressions.....	240
().....	240
[].....	240
. (dot).....	241
->	241
15.8 Reference/Dereference Operators.....	242
&.....	242
*	242
15.9 Conditional Operators	243
?:.....	243
15.10 Other Operators	244
(type)	244
sizeof	244
,.....	245

16. Graphical User Interface

16.1 The GUI Environment	246
16.1.1 Editing	246
16.1.2 Menus	247
16.1.3 Using Keyboard Shortcuts	247
16.1.4 Editor Window Popup Menu	248
16.2 File Menu.....	249
16.3 Edit Menu	251
16.4 Compile Menu	254
16.5 Run Menu	256
16.6 Inspect Menu.....	259
16.7 Options Menu.....	263
16.7.1 Environment Options	263
16.7.2 Project Options	280
16.7.3 Toolbars	294
16.8 Window Menu	296
16.9 Help Menu	303

17. Command Line Interface

17.1 Default States	306
17.2 User Input	306
17.3 Saving Output to a File.....	307
17.4 Command Line Switches	307
17.4.1 Switches Without Parameters	307
17.4.2 Switches Requiring a Parameter	314
17.5 Examples.....	319
17.6 Command Line RFU.....	319

18. Project Files

18.1 Project File Names	322
18.1.3 Active Project	322
18.2 Updating a Project File.....	323
18.3 Menu Selections	323
18.4 Command Line Usage	324

19. Hints and Tips

19.1 A User-Defined BIOS.....	325
19.2 Efficiency.....	326
19.2.1 Nodebug Keyword	326
19.2.2 In-line I/O	327
19.3 Run-time Storage of Data.....	327
19.3.1 User Block	327
19.3.2 WriteFlash2	328
19.3.3 Battery-Backed RAM	328
19.4 Root Memory Reduction Tips	328

19.4.1 Increasing Root Code Space	328
19.4.2 Increasing Root Data Space	330

Appendix A. Macros and Global Variables

A.1 Macros Defined by the Compiler.....	331
A.2 Macros Defined in the BIOS or Configuration Libraries	332
A.3 Global Variables	333
A.4 Exception Types	334
A.5 Rabbit Registers.....	334
A.5.1 Shadow Registers	334

Appendix B. Map File Generation

B.1 Grammar	335
-------------------	-----

Appendix C. Security Software & Utility Programs

C.1 Dynamic C Utilities	336
C.0.1 Rabbit I/O LIB Utility	336
C.0.2 Library File Encryption	337
C.0.3 File Compression Utility	338
C.0.4 Font and Bitmap Converter Utility..	340
C.0.5 Rabbit Field Utility Module	340

Software License Agreement

344

Index.....

347

1. INSTALLING DYNAMIC C

Insert the installation disk or CD in the appropriate disk drive on your PC. The installation should begin automatically. If it doesn't, issue the Windows "Run..." command and type the following command:

```
<disk> : \SETUP
```

The installation program will begin and guide you through the installation process.

1.1 Requirements

Dynamic C requires an IBM-compatible PC running Windows 2000 or later with at least one free COM or USB port.

Please note that Windows Vista is supported by Dynamic C out of the box if there is only one processor in the host PC or laptop. With multiple processors (a.k.a., dual cores) present in the host system, you must check Windows "Processor Affinity" setting in order to ensure Vista compatibility with Dynamic C. Technical note TN257 "Running Dynamic C with Windows Vista" has instructions for modifying the "Processor Affinity" setting. This technical note is available on the Rabbit website:

www.rabbit.com/support/techNotes_whitePapers.shtml#dcp

Starting with Dynamic C 10.21, the "Processor Affinity" setting is set automatically.

1.2 Assumptions

It is assumed that the reader has a working knowledge of:

- The basics of operating a software program and editing files under Windows on a PC.
- Programming in a high-level language.
- Assembly language and architecture for controllers.

Refer to one or both of the following texts for a full treatment of C:

- *The C Programming Language* by Kernighan and Ritchie (published by Prentice-Hall).
- *C: A Reference Manual* by Harbison and Steel (published by Prentice-Hall).

2. INTRODUCTION TO DYNAMIC C

Dynamic C is an integrated development system for writing embedded software. It is designed for use with Rabbit controllers and other controllers based on the Rabbit microprocessor.

2.1 The Nature of Dynamic C

Dynamic C integrates the following development functions into one program:

- Editing
- Compiling
- Linking
- Loading
- Debugging

Dynamic C has an easy-to-use, built-in, full-featured text editor. Dynamic C programs can be executed and debugged interactively at the source-code or machine-code level. Pull-down menus and keyboard short-cuts for most commands make Dynamic C easy to use.

Dynamic C also supports assembly language programming. It is not necessary to leave C or the development system to write assembly language code. C and assembly language may be mixed together.

Debugging under Dynamic C includes the ability to use `printf` commands, watch expressions, break-points and stack tracing. Watch expressions can be used to compute C expressions involving the target's program variables or functions. Watch expressions can be evaluated while stopped at a breakpoint or while the target is running its program. Stack tracing shows function call sequences and parameter values.

Dynamic C provides extensions to the C language (such as *shared* and *protected* variables, *costatements* and *cofunctions*) that support real-world embedded system development. Dynamic C supports cooperative and preemptive multitasking.

Dynamic C comes with many function libraries, all in source code. These libraries support real-time programming, machine level I/O, and provide standard string and math functions.

2.1.1 Speed

Dynamic C compiles directly to memory. Functions and libraries are compiled and linked and downloaded on-the-fly. On a fast PC, Dynamic C might load 30,000 bytes of code in five seconds at a baud rate of 115,200 bps.

2.2 New Features from ANSI C

New features from ANSI/ISO C90 are gradually being added to Dynamic C.

The following features were introduced in Dynamic C 10.60:

- **Variable initializer support:** Variables can now be initialized within a declaration.
- **Preprocessor support for the "defined" keyword:** The "defined" keyword can now be used in #if / #elif expressions to determine whether a macro has been previously defined.
- **#include support:** The standard C mechanism of using "#include" to include other source files is now supported.

The following feature was introduced with Dynamic C 10.62:

- **Function pointer parameter list checking:** Function pointers may now contain a parameter list, and the compiler will check the parameters and perform automatic type promotion when a function is called through the function pointer.

The following features were introduced with Dynamic C 10.64:

- **"File Scoping:** In projects using multiple .C files, each C source file now defines a new scope separate from all other C files. Using the `static` keyword ensures that file-scope variables and functions are visible only within the file in which they are defined. Omitting the `static` or using `extern` will link those symbols to other files where they are used. The new functionality obeys the ANSI-C rules for file scoping for .C and .H files. The Dynamic C extension `#use` (which works with .LIB files) works with the new scoping with some important caveats noted in section 4.7 "Libraries".
- **"Nested/block Scoping:** Nested, or block, scoping allows the declaration of variables within a curly-brace-delimited block. Previously, Dynamic C only allowed declarations at the beginning of a function block (as defined by the original K&R C specification). In addition, `#asm` assembly blocks now each have their own local (function) block scope preventing name collisions between global and local assembly labels.
- **"Const Correctness:** Dynamic C now handles the functionality of the `const` keyword as it is defined in the ANSI-C89/ISO-C90 specification. See [Section 4.4 "The const Keyword"](#) for information on the differences between the older Dynamic C functionality and the new ANSI functionality.
- **"signed Keyword:** The `signed` keyword is now supported. Variables of type `char` can also now be signed; previously, `char` variables could only be unsigned.

2.3 Dynamic C Enhancements and Differences

Dynamic C offers a number of extensions to the standard C language. These extensions are targeted for making your embedded development easier.

2.3.1 Dynamic C Enhancements

Many enhancements have been added to Dynamic C. Some of these are listed below.

- Dynamic C 10.54 introduces remote firmware updates for some board types. Please see AN421 "Remote Program Update" for more information. This document is available on the Dynamic C software CD and on the [Rabbit Support web site](#).

- **Function Chaining**, a concept unique to Dynamic C, allows special segments of code to be embedded within one or more functions. When a named function chain executes, all the segments belonging to that chain execute. Function chains allow software to perform initialization, data recovery, or other kinds of tasks on request. Dynamic C also provides a special function chain called `_GLOBAL_INIT` which can be used for initialization code. The `_GLOBAL_INIT` function chain is executed at the start of the program. Dynamic C also provides a special function chain called `_GLOBAL_INIT` which can be used for initialization code. The `_GLOBAL_INIT` function chain is executed at the start of the program.
- **Costatements** allow cooperative, parallel processes to be simulated in a single program.
- **Cofunctions** allow cooperative processes to be simulated in a single program.
- **Slice Statements** allow preemptive processes in a single program.
- Dynamic C supports embedded **assembly code** and stand-alone assembly code.
- Dynamic C has keywords that help protect data shared between different contexts (**shared**) or stored in battery-backed memory (**protected**).
- Dynamic C has a set of features that allow the programmer to make the fullest use of `xmem` (extended memory). Up until the release of Dynamic C 10.21, the compiler supported a 1 MB physical address space. Starting with Dynamic C 10.21, the compiler supports up to the 16 MB of physical memory; up to 16 MB can be used for data and up to 1 MB can be used for code. (Dynamic C has been verified to work with Rabbit-based boards with up to 4.5 MB of memory.)

Normally, Dynamic C takes care of memory management, but there are instances where the programmer will want to take control of it. Dynamic C has keywords and directives to help put code and data in the proper place, such as: `root`, `xmem`, and `#memmap` for code and `far` for data.

See [Chapter 10](#) for further details on memory management.

- The `#use` statement allows you to create library files that include your function declarations and definitions together. Starting with Dynamic C 10.60, you can use the standard `#include` mechanism instead.

2.3.2 Dynamic C Differences

The main differences in Dynamic C are summarized in the list below and discussed in detail in [Chapter 4](#). “Language” and [Chapter 14](#). “Keywords.”

- Bit fields are not supported.
- Separate compilation of different parts of the program is not supported.

3. QUICK TUTORIAL

Sample programs are provided in the Dynamic C Samples folder, which is in the root directory where Dynamic C was installed. The Samples folder contains many subfolders, as shown in Figure 3.1. Sample programs are provided in source code format. You can open the source code file in Dynamic C and read the comment block at the top of the sample program for a description of its purpose and other details. Comments are also provided throughout the source code. This documentation, provided by the software engineers, is a rich source of information.

Figure 3.1 Screenshot of Samples Folder

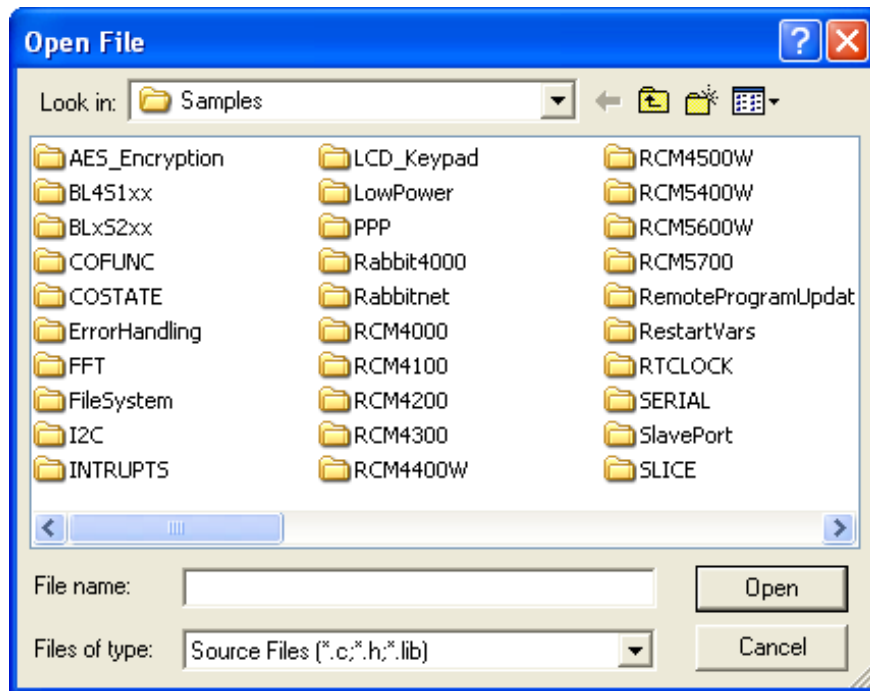

The subfolders contain sample programs that illustrate the use of the various Dynamic C libraries. For example, the subfolders “Cofunc” and “Costate” have sample programs illustrating the use of `COFUNC.LIB` and `COSTATE.LIB`, libraries that support cooperative multitasking using Dynamic C language extensions. Besides its subfolders, the Samples folder also contains some sample programs to demonstrate various aspects of Dynamic C. For example, the sample program `Pong.c` demonstrates output to the Stdio window.

In the rest of this chapter we examine three sample programs in some detail.

3.1 Run DEMO1.C

This sample program will be used to illustrate some of the functions of Dynamic C. Open the file `Samples\DEMO1.C` using the File menu or the keyboard shortcut `<Ctrl+O>`. The program will appear in a window, as shown in [Figure 3.2](#) (minus some comments). Use the mouse to place the cursor on the function name `printf` in the program and press `<Ctrl+H>`. This brings up a [Function Description](#) window for `printf()`. You can do this with all functions in the Dynamic C libraries, including libraries you write yourself.

Figure 3.2 Sample Program DEMO1.C

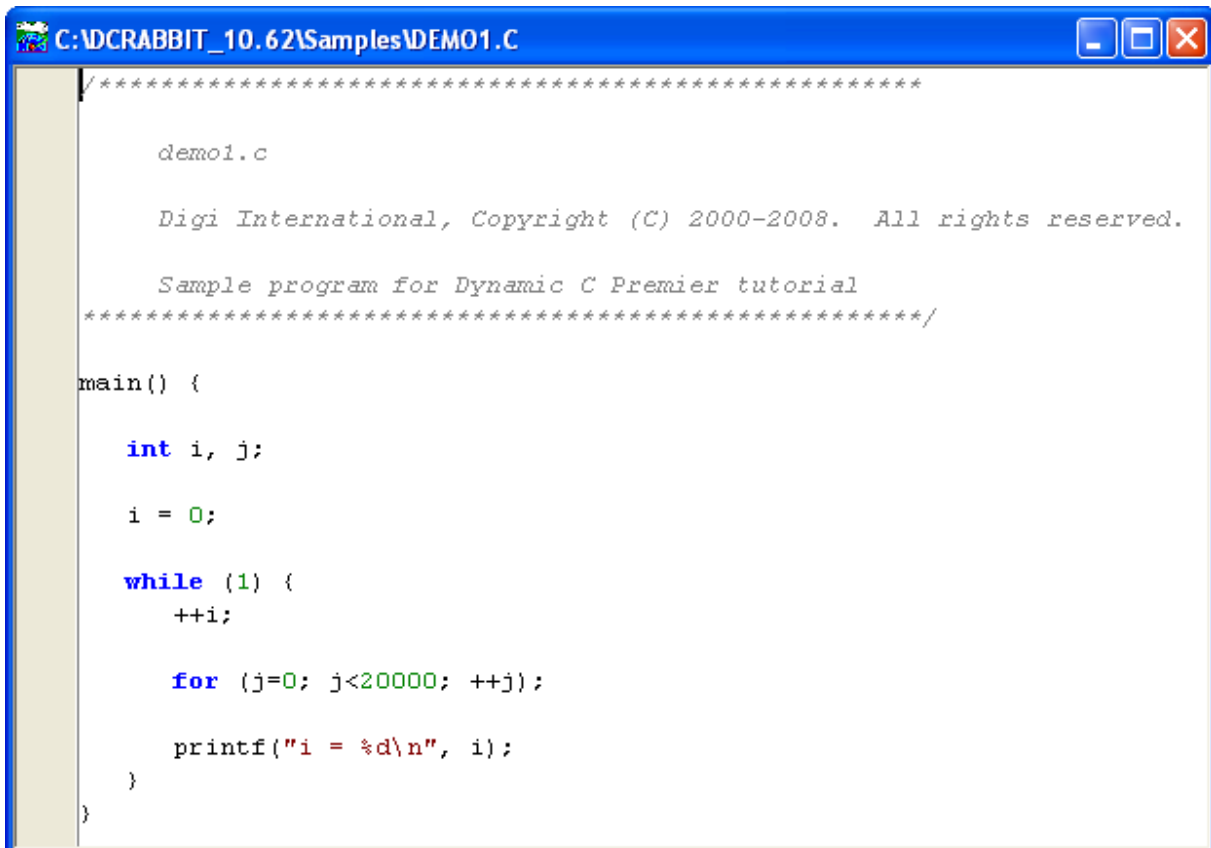

```
/*
*****
demo1.c

Digi International, Copyright (C) 2000-2008. All rights reserved.

Sample program for Dynamic C Premier tutorial
*****/

main() {

    int i, j;

    i = 0;

    while (1) {
        ++i;

        for (j=0; j<20000; ++j);

        printf("i = %d\n", i);
    }
}
```



To run `DEMO1.C` compile it using the Compile menu, and then run it by selecting “Run” in the Run menu. (The keyboard shortcut `<F9>` will compile and run the program. You may also use the green triangle toolbar button as a substitute for `<F9>`.)

The value of the counter should be printed repeatedly to the Stdio window if everything went well. If this doesn’t work, review the following points:

- The target should be ready, indicated by the message “BIOS successfully compiled...” If you did not receive this message or you get a communication error, recompile the BIOS by pressing `<Ctrl+Y>` or select “Reset Target / Compile BIOS” from the Compile menu.
- A message reports “No Rabbit Processor Detected” in cases where the wall transformer is not connected or not plugged in.
- The programming cable must be connected to the controller. (The colored wire on the programming cable is closest to pin 1 on the programming header on the controller). The other end of the program-

ming cable must be connected to the PC serial port. The COM port specified in the Communications dialog box must be the same as the one the programming cable is connected to. (The Communications dialog box is accessed via the Communications tab of the Options | Project Options menu.)

- To check if you have the correct serial port, press <Ctrl+Y>. If the “BIOS successfully compiled ...” message does not display, choose a different serial port in the Communications dialog box until you find the serial port you are plugged into. Don’t change anything in this menu except the COM number. The baud rate should be 115,200 bps and the stop bits should be 1.

3.1.1 Single Stepping



To experiment with single stepping, we will first compile DEMO1 .C to the target without running it. This can be done by clicking the compile button on the task bar. This is the same as pressing F5. Both of these actions will compile according to the setting of “Default Compile Mode.” (See “Default Compile Mode” in Chapter 16, for how to set this parameter.) Alternatively you may select Compile | Compile to Target from the main menu.



After the program compiles a highlighted character (green) will appear at the first executable statement of the program. Press the <F8> key to single step (or use the toolbar button). Each time the <F8> key is pressed, the cursor will advance one statement. When you get to the statement: `for (j=0, j< . . .`, it becomes impractical to single step further because you would have to press <F8> thousands of times. We will use this statement to illustrate watch expressions.

3.1.2 Watch Expression



Watch expressions may only be added, deleted or updated in run mode. To add a watch expression click on the toolbar button pictured here, or press <Ctrl+W> or choose “Add Watch” from the Inspect menu. The Add Watch Expression popup box will appear. Type the lower case letter “j” and click on either “Add” or “OK.” The former keeps the popup box open, the latter closes it. Either way the Watches window appears. This is where information on watch expressions will be displayed. Now continue single stepping. Each time you do, the watch expression (j) will be evaluated and printed in the Watches window. Note how the value of “j” advances when the statement `j++` is executed.

3.1.3 Breakpoint

Move the cursor to the start of the statement:

```
for (j=0; j<20000; j++);
```

To set a breakpoint on this statement, press <F2> or select “Toggle Breakpoint” from the Run menu. A red highlight appears on the first character of the statement. To get the program running at full speed, press <F9>. The program will advance until it hits the breakpoint. The breakpoint will start flashing both red and green colors.

To remove the breakpoint, press <F2> or select “Toggle Breakpoint” on the Run menu. To continue program execution, press <F9>. You will see the value of “i” displayed in the Stdio window repeatedly until program execution is halted.

You can set breakpoints while the program is running by positioning the cursor to a statement and using the <F2> key. If the execution thread hits the breakpoint, a breakpoint will take place. You can toggle the breakpoint with the <F2> key and continue execution with the <F9> key.

You can also set breakpoints while in edit mode. Breakpoint information is not only retained when going back and forth from edit mode to debug mode, it is stored when a file is closed and restored when the file is re-opened.

3.1.4 Editing the Program

Press <F4> to put Dynamic C into edit mode. Use the “Save as” choice on the File menu to save the file with a new name so as not to change the original demo program. Save the file as MYTEST . C. Now change the number 20000 in the `for` statement to 10000. Then use the <F9> key to recompile and run the program. The counter displays twice as quickly as before because you reduced the value in the delay loop.

3.2 Run DEMO2.C

Go back to edit mode and open the program DEMO2 . C. This program is the same as the first program, except that a variable `k` has been added along with a statement to increment “`k`” by the value of “`i`” each time around the endless loop. Compile and run DEMO2 . C.

3.2.1 Watching Variables Dynamically

Press <Ctrl+W> to open the “Add Watch Expression” popup box.

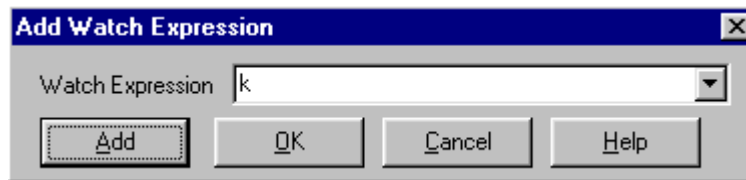

Type “`k`” in the text entry box, then click “OK” (or “Add”) to add the expression “`k`” to the top of the list of watch expressions. Now press <Ctrl+U>, the keyboard shortcut for updating the watch window. Each time you press <Ctrl+U>, you will see the current value of `k`.

Add another expression to the watch window:

`k*5`

Then press <Ctrl+U> several times to observe the watch expressions “`k`” and “`k*5`.”

3.3 Run DEMO3.C

The example below, sample program DEMO3 . C, uses costatements. A costatement is a way to perform a sequence of operations that involve pauses or waits for some external event to take place.

3.3.1 Cooperative Multitasking

Cooperative multitasking is a way to perform several different tasks at virtually the same time. An example would be to step a machine through a sequence of tasks and at the same time carry on a dialog with the operator via a keyboard interface. Each separate task voluntarily surrenders its compute time when it does not need to perform any more immediate activity. In preemptive multitasking control is forcibly removed from the task via an interrupt.

Dynamic C has language extensions to support both types of multitasking. For cooperative multitasking the language extensions are *costatements* and *cofunctions*. Preemptive multitasking is accomplished with *slicing* or by using the μ C/OS-II real-time kernel. The μ C/OS-II real-time kernel is included with Dynamic C starting with Dynamic C version 10.21. The other multitasking software has always shipped with all versions of Dynamic C.

3.3.1.1 Advantages of Cooperative Multitasking

Unlike preemptive multitasking, in cooperative multitasking variables can be shared between different tasks without taking elaborate precautions. Cooperative multitasking also takes advantage of the natural delays that occur in most tasks to more efficiently use the available processor time.

The DEMO3 . C sample program has two independent tasks. The first task prints out a message to Stdio once per second. The second task watches to see if the keyboard has been pressed and prints the entered key.

```
main() {
    int secs;                // seconds counter
    secs = 0;                // initialize counter
    (1) while (1) {          // endless loop

        // First task will print the seconds elapsed.
        (2)  costate {
                secs++;      // increment counter
            (3)  waitFor( DelayMs(1000) ); // wait one second
                printf("%d seconds\n", secs); // print elapsed seconds
            (4)  }

        // Second task will check if any keys have been pressed.
                costate {
            (5)  if ( !kbhit() ) abort; // key been pressed?
                printf(" key pressed = %c\n", getchar() );
                }

        (6) }                // end of while loop
    }                          // end of main
```

The numbers in the left margin are reference indicators and not part of the code. Load and run the program. The elapsed time is printed to the Stdio window once per second. Push several keys and note how they are reported.

The elapsed time message is printed by the costatement starting at the line marked (2). Costatements need to be executed regularly, often at least every 25 ms. To accomplish this, the costatements are enclosed in a `while` loop. The `while` loop starts at (1) and ends at (6). The statement at (3) waits for a time delay, in this case 1000 ms (one second). The costatement executes each pass through the `while` loop. When a `waitfor` condition is encountered the first time, the current value of `MS_TIMER` is saved and then on each subsequent pass the saved value is compared to the current value. If a `waitfor` condition is not encountered, then a jump is made to the end of the costatement (4), and on the next pass of the loop, when the execution thread reaches the beginning of the costatement, execution passes directly to the `waitfor` statement. Once 1000 ms has passed, the statement after the `waitfor` is executed. A costatement can wait for a long period of time, but not use a lot of execution time. Each costatement is a little program with its own statement pointer that advances in response to conditions. On each pass through the `while` loop as few as one statement in the costatement executes, starting at the current position of the costatement's statement pointer. Consult [Chapter 5](#) for more details.

The second costatement in the program checks to see if an alpha-numeric key has been pressed and, if one has, prints out that key. The `abort` statement is illustrated at (5). If the `abort` statement is executed, the internal statement pointer is set back to the first statement in the costatement, and a jump is made to the closing brace of the costatement.

Observe the value of `secs` while the program is running. To illustrate the use of snooping, use the watch window to observe `secs` while the program is running. Add the variable `secs` to the list of watch expressions, then press <Ctrl+U> repeatedly to observe as `secs` increases.

3.4 Summary of Features

This chapter provided a quick look at the interface of Dynamic C and some of the powerful options available for embedded systems programming. The following several paragraphs are a summary of what we've discussed.

Development Functions

When you load a program it appears in an editor window. You compile by clicking `Compile` on the task bar or from the `Compile` menu. The program is compiled into machine language and downloaded to the target over the serial port. The execution proceeds to the first statement of `main`, where it pauses, waiting to run. Press <F9> or select "Run" on the `Run` menu. If want to compile and run the program with one keystroke, use <F9>, the run command; if the program is not already compiled, the run command compiles it.

Single Stepping

This is done with the F8 key. The F7 key can also be used for single stepping. If the F7 key is used, then descent into functions will take place. With F8 the function is executed at full speed when the statement that calls it is stepped over.

Setting Breakpoints

The F2 key is used to toggle a breakpoint at the cursor position. Breakpoints can be toggled while in run mode, either while stopped at a breakpoint or when the program is running at full speed. Breakpoints can also be set in edit mode and retained when changing modes or closing the file.

Watch Expressions

A watch expression is a C expression that is evaluated on command in the Watches window. An expression is basically any type of C statement that can include operators, variables, structures and function calls, but not statements that require multiple lines such as `for` or `switch`. You can have a list of watch expressions in the Watches window. If you are single stepping, then they are all evaluated on each step. You can also command the watch expressions to be evaluated by using the `<Ctrl+U>` command. When a watch expression is evaluated at a breakpoint, it is evaluated as if the statement was at the beginning of the function where you are single stepping.

Costatements

A costatement is a Dynamic C extension that allows cooperative multitasking to be programmed by the user. Keywords, like `abort` and `waitfor`, are available to control multitasking operation from within costatements.

4. LANGUAGE

Dynamic C is based on the C language. The programmer is expected to know programming methodologies and the basic principles of the C language. Dynamic C has its own set of libraries, which include user-callable functions. Please see the *Dynamic C Function Reference Manual* for detailed descriptions of these API functions. Dynamic C libraries are in source code, allowing the creation of customized libraries.

Before starting on your application, read through the rest of this chapter to understand the differences between standard C and Dynamic C.

For more information on the C language, see a reference book such as *The C Programming Language* by Kernighan and Ritchie (published by Prentice-Hall).

4.1 Storage Classes

Variable storage can be `auto` or `static`. The term “static” means the data occupies a permanent fixed location for the life of the program. The term “auto” refers to variables that are placed on the system stack for the life of a function call. The default storage class is `auto`, but can be changed by using `#class static`; however, using this compiler directive with “static” is deprecated starting with Dynamic C 10.44.

The default storage class can be superseded by the use of the keyword `auto` or `static` in a variable declaration. These keywords apply to local variables, that is, variables defined within a function. If a variable does not belong to a function, it is called a global variable—available anywhere in the program—but there is no keyword in C to represent this fact. Global variables always have static storage.

The `register` type is reserved, but is not currently implemented. Dynamic C will change a variable to be of type `auto` if `register` is encountered. Even though the `register` keyword is not implemented, it still can not be used as a variable name or other symbol name. Its use will cause unhelpful error messages from the compiler.

4.2 Pointers

Pointer checking is a run-time option in Dynamic C. Use the Compiler tab on the Options | Project Options menu. Pointer checking will catch attempts to dereference a pointer to unallocated memory. However, if an uninitialized pointer happens to contain the address of a memory location that the compiler has already allocated, pointer checking will not catch this logic error. Because pointer checking is a run-time option, pointer checking adds instructions to code when pointer checking is used.

Pointer checking is not currently supported for far pointers.

4.3 Far Pointers and Far Data

This section examines the syntax of the `far` keyword, using examples from simple variables to complex aggregate types.

4.3.1 The far Qualifier

The `far` keyword allows a programmer to directly declare variables in `xmem`. Previous to this development, usage of `xmem` was limited to library routines such as `root2xmem()` and `xmem2root()` using memory allocated using `xalloc`. Now, the compiler will directly generate code to access `xmem` allocated through standard variable declarations with the addition of the `far` keyword.

4.3.2 Basic Declarations

In almost all respects, `far` behaves syntactically identically to the `const` qualifier.

The keyword `far` was added to use the same basic principles as `const`, with a few exceptions. The reason for this is that `far` and `const` both indicate the storage type for variables. In the case of `const`, the storage is in the flash device. Variables declared as `far` are stored in `xmem` in RAM (and can therefore be modified). A variable can also be declared as `const far`, which places the constant variable in the `xmem` space on the flash device.

```
far type var;           // Declares a variable "var" having far storage
```

We also allow

```
type far var;
```

which has the same meaning as the previous declaration. In other words, the `far` keyword may appear before or after the base type.

We do **not** allow

```
far type far var;
```

In this context, these are base type qualifiers. The `far` keyword can also qualify pointer types, such as in the following example:

```
type * far ptr;
```

This declares a variable, `ptr`, having `far` storage pointing to an object of type `type`. Pointer qualifiers are always found on the right-hand side of the ‘*’ token.

Here is a slightly more complex declaration:

```
far type * far ptr;
```

Here, the object type to which `ptr` points is qualified as having `far` storage.

4.3.3 Multi-Level Far Pointers

The semantics of the `far` qualifier can become quite complex if used with multi-level pointers. Some confusion arises when thinking about how to qualify different pointer levels in a more complex declaration such as the following basic pointer-to-pointer declaration:

```
type * * ptr;
```

This declares `ptr` as a variable which points to an object of type pointer to type, or simply, `ptr` is a pointer to pointer-to-type. What if we wanted to declare `ptr` to be a pointer to a pointer having `far` storage (the pointer to type is in `xmem`, but what it points to is in `root`)? This would have the following declaration:

```
type * far * ptr;
```

Here we see that pointer declarations are right-associative. Recalling that the `far` qualifier associates with the `*` token to its left, we see that the nested pointer type is the left `*` not the right one, illustrated using brackets:

```
[type * far] * ptr;
```

In the above example, the association of the `*` and `far` is evident – the variable `ptr` is a pointer-in-root, and it points to a pointer-in-`far`.

For another example, a complex and infrequent declaration might be:

```
far type * far * * far ptr;
```

A succinct way of stating the type of `ptr` in this example would be: `ptr` is a pointer-in-`far` to a pointer-in-root to a pointer-in-`far` to a variable of type having `far` storage.

4.3.4 Arrays and Structures

The `far` qualifier can also be applied to arrays and structures, with the effect of the compiler allocating storage for those variables from `xmem`. The declarations for both structures and arrays (and pointers to those types) follow the same rules as basic type variable declarations. An example structure declaration might be:

```
struct S {
    int a;
    char b[20];
};
far struct S str;           // A structure of type S in xmem
```

Note that the `far` qualifier is applied only to the actual declaration of a variable with the structure type, not the structure definition itself. The `far` qualifier may not be applied to either a structure type definition or any member of a structure. If a structure instance variable is placed in `xmem` using the `far` keyword, then all members of that instance are in `xmem` – you can not mix `xmem` and `root` within a single structure.

Arrays can also be placed in xmem using `far`. The following is a possible declaration of an array in xmem:

```
far type array[5000];          // An array of 5000 elements of type type in xmem
```

Note that the size limit imposed on arrays in root memory (32,767 bytes) also apply to far arrays. You can declare an array as large as your largest contiguous free block of xmem available up to this limit. See [Chapter 10 “Memory Management”](#) for more information on how xmem is allocated and used by the compiler.

4.3.5 Complex Declarations

All of the elements discussed so far can be applied in a single declaration to produce very complex types for variables. As an example, such a declaration may look like the following:

```
const type (* far const ptr)[c0][c1] = &const_array;
```

In this example, `ptr` is a constant pointer-in-far (xmem constant) to a 2-dimensional array of `c0` x `c1` elements of type constant type. In other words, we have a pointer in xmem to a two-dimensional array of constant elements. The array the pointer is pointing to is in root memory, since the `far` qualifier only associates with the pointer variable itself. The pointer is constant, so it must be initialized, and the first `const` implies that we can not change the elements in the array since they represent constants (which are in flash and can not be modified). We assume that `c0`, `c1`, and `const_array` are all constant variables or literals defined previously.

4.3.6 Sample Programs

From the Dynamic C installation directory, look in `/Samples/Rabbit4000/FAR/` for sample programs demonstrating the use of the `far` keyword. The sample `far_demo.c` shows how to declare a local variable that will be stored in far memory (which means it must be declared `static`) and accessed just like any other local variable. The sample `LinkedList.c` demonstrates far pointers and includes a library, `LinkedList.LIB`, that creates and maintains a linked list in the far memory space.

4.4 The const Keyword

4.4.1 Simple Constants

The `const` keyword allows a programmer to tell the compiler that a particular "variable" should not be modified¹ after the initial assignment in its declaration. If any code tries to assign a new value to that variable, the compiler will generate a warning or error indicating that the assignment operation should not occur. This allows a programmer to prevent unwanted modifications to variables that for some reason should not be changed. Note that `const` variables **must** be initialized; otherwise there is no other way to assign them values.

The following is an example of a simple declaration of a constant integer:

```
const int number = 42;
```

Note that the `const` in the above declaration can also come after the type, as in the following:

```
int const number = 42;
```

This may look a little strange, but it is consistent with the pointer syntax (described below) and may show up in code from time to time.

In a simple `const` variable declaration any storage type may be used. It is possible to have an auto `const` variable; it simply means that the value is stored on the stack and cannot be modified. In most cases, simple `const` declarations should probably be static (this is not the case with pointers, as we will see below). Constants are non-modifiable so multiple accesses (say via a re-entrant function) will all be reads, thus making a single storage location preferable to allocating space for the constant on the stack for each call.

Prior to Dynamic C 10.64, the `const` keyword required static storage in all cases. This restriction has been removed and `const` now obeys the ANSI C89 semantics described above.

4.4.2 Const and Pointers

Simple variable declarations with `const` are straightforward and fairly easy to understand. However, `const` is much more interesting when applied to pointers. The rules are fairly simple, but the resulting behavior can be somewhat confusing.

To begin, let's look at the declaration for a simple pointer, in this case a string literal constant:

```
const char * string = "ABCD";
```

Here we see a `const` modifier on a pointer declaration. As in the simple declaration in the previous section, the declaration starts with `const`. However, since this is a pointer, the meaning may be slightly confusing. The `const` in this case actually refers to the character being pointed at (the 'A' in the string literal "ABCD") and **not** the variable `string`. The reason for this is that `string` is actually a pointer to a constant string, in

1. Technically, a `const`-modified variable is no longer "variable" but most C documentation on the subject does not make this distinction.

this case our literal value. The pointer *string* is actually a variable that can be modified, but dereferencing *string* and assigning to it will result in an error:

```
string = &another_string; // This is OK
*string = 'X'; // WARNING
```

Now, it is possible to make *string* into a constant, and C provides a somewhat unintuitive syntax, as follows:

```
char * const const_string = &another_string;
```

In this declaration, note that the `const` modifier comes after the `"*"` defining *string* to be a pointer. In this case, *const_string* itself is constant and cannot be modified, but what it points to can be, as in the following:

```
const_string = &yet_another_string; // WARNING
*const_string = 'X'; // This is OK
```

Furthermore, it is possible to declare both the pointer and what it points to as constant, with the resulting behavior:

```
const char * const really_const_string = "ABCD"; // Declaration
really_const_string = &yet_another_string; // WARNING
*really_const_string = 'X'; // WARNING
```

The `const` modifier can be applied in turn to each level of pointer, following the `"*"` for that level, as follows:

```
const char * const * const const_ptr = &ptr_array;
```

Multiple-level pointers have some tricky semantics with regard to conversions, as we will see in the next section.

4.4.3 Const Conversions, Casting, and Parameter Passing

4.4.3.1 Conversions

The `const` modifier, when applied to variables in C, must obey a number of conversion rules similar to those for integer promotion. As a result, there are some tricky conversion subtleties that are good to know, though the compiler should catch them for you. Note that the conversions in this section apply only to assignments since the use of `const` in function parameters has some counterintuitive consequences.

We have already seen an implicit cast when assigning a constant to another non-`const` variable. In the following, the cast occurs at the assignment of the constant to the variable, and the conversion effectively discards the `const`:

```
const int const_num = 42;
int non_const_num;
non_const_num = const_num;
```

In this specific case, it does not really matter that the `const` was discarded since the non-`const` variable is actually assigned a copy of the value of the constant. However, when we look at pointers with `const`, there is a lot more complexity:

```
const int number = 42;
const int *const_ptr;
int *non_const_ptr;
const_ptr = &number; // OK
non_const_ptr = const_ptr; // WARNING
```

In this example, the variable `non_const_ptr` is a pointer to a non-`const` integer, so when the assignment occurs the `const` is discarded, but since `const_ptr` points at a value that should not be modified (because it is `const`), then the compiler will issue a warning. Remember that the pointers in this example are not `const` since there is no `const` following the `*` in either declaration. We will see later how `const` can be cast away explicitly to remove the warning.

The above example demonstrated a condition where the compiler will generate a warning, but this is due to the fact that `const` was being discarded possibly inadvertently. However, the same does not apply for the operation in reverse:

```
int non_const_number = 42;
const int *const_ptr;
int *non_const_ptr;
non_const_ptr = &non_const_number; // OK
const_ptr = non_const_ptr; // OK
```

This example demonstrates that we can often make something more `const`, that is, we can convert a pointer-to-non-`const` to a pointer-to-`const` without issue because the thing being pointed to can be modified, and it is OK if the pointer to it restricts that modification. This can be thought of as being akin to the integer promotion rules - conversion to a bigger type is okay because there are enough bits to represent the smaller number, but conversion to a smaller type generates a warning because data is potentially being lost.

The above case applies to single-level pointers, but in the case of multi-level pointers there are restrictions on const because of some subtleties that multiple levels of pointers introduce. Consider the following example:

```
int const **const_ptr;
int **non_const_ptr;
const_ptr = non_const_ptr; // WARNING
```

The above example shows a case where assigning a pointer to a "more const" pointer is a problem. The reason for this is that it is possible to accidentally discard a const when using two or more pointer levels. The compiler checks for this and issues a warning to prevent what can result in very subtle problems.

4.4.3.2 Casting

Though not usually recommended, we can get around const warnings through the use of explicit casting. This usually comes in handy when interfacing with code you do not have access to or the time to correctly implement const everywhere in your application. With casting, our former warnings go away:

```
const int number = 42;
const int *const_ptr;
int *non_const_ptr;
const_ptr = &number; // OK
non_const_ptr = (int *)const_ptr; // OK with cast
```

Note that in this example, accesses through the non_const_pointer variable will result in possible runtime errors depending on how the target variable number is stored - for example, if number was stored in flash (because it is a constant) then writes to it will not work.

4.4.3.3 Parameter Passing

Parameter passing is a special case for const, essentially because parameters in a function call are equivalent to initializers for the corresponding arguments in the function prototype. For this reason, the function call in this next example is correct even though the direct assignment to an equivalent variable is wrong:

```
void foo(const int foo_x) { // No initializer allowed
    // foo_x cannot be modified
}

int non_const_num = 5;
const int x = 2; // equivalent declaration to parameter foo_x above
foo(non_const_num); // OK
x = non_const_num; // WARNING
```

The basic rule for non-pointer function parameter passing is that you can always pass something that is "less const" to a function expecting a parameter that is "more const". For pointers, it is a little trickier because of the multiple-level pointer issue mentioned previously. The following example illustrates the problem with multiple-level pointer parameters to functions:

```

void bad_const(const char **a, const char **b) {
    *b = *a;
}

main() {
    const char *foo = "hello";
    char *bar;

    bad_const(&foo, &bar);
    // bar now points at foo, discarding const
    bar[3] = 'g'; // !!! this modifies what foo points to
    printf("%s\n", foo);
    return;
}

```

In the above example, *foo* is a pointer to a const and *bar* is a pointer to non-const. Even though the parameter *b* in the function *bad_const* appears to be more const than *bar*, the problem is that the pointer dereference and assignment in the function will allow the non-const *bar* to point at the const data pointed to by *foo* in the main function. The subsequent assignment to an element of *bar* actually modifies the string literal "hello". Depending on the location of that string literal the assignment could cause a program failure, or at best a modification of a string the programmer explicitly declared as being const. The compiler checks for this type of parameter passing and warns to prevent this type of error.

4.4.4 Dynamic C Version Differences

The following table demonstrates some examples of `const` behavior prior to the ANSI-compliant `const` behavior in Dynamic C 10.64, and compares the old non-ANSI behavior with the new to give you an idea of how to port code from older versions of Dynamic C. Note that non-`const` initializers were added in Dynamic C 10.60 so there will be some subtle differences porting from that version as compared to porting from earlier versions.

Note that `const` used to explicitly define the storage of the associated value to be in flash. On later devices that store the program in flash but run in RAM, the `const` values were stored with the code in RAM following the startup flash-to-RAM copy. With `const` correctness, the storage is defined by the storage class (auto or static) and literals are stored in flash (or with the code for run-in-RAM devices).

Table 4-1.

Const example	Dynamic C Behavior	Behavior in Dynamic C 10.64 and Later
<code>const int x = 10;</code>	x is stored in flash ^a	x is stored in the default storage class (auto in functions, otherwise extern) and is non-modifiable (const). The value x may be stored in flash.
<code>auto const x = 10;</code>	Error, auto const not allowed ^a	x is stored on the stack but is not modifiable
<code>const char* s = "ABCD";</code>	"ABCD" and s are both const and stored in flash. Prior to version 10.60, a second const (for the pointer) was required and this code would have produced a warning. ^a	"ABCD" is stored in flash/constant space, but s is stored using the default storage class and is modifiable (non-const)
<code>const char * const s = "ABCD";</code>	Same as <code>'const char* s = "ABCD"'</code> ^a	"ABCD" and s are both const and stored in flash/constant space
<code>char * const ptr = &s;</code>	Error (prior to Dynamic C 10.62) - some older versions would ask for const before the "char". More recently this would compile without error. ^a	The variable ptr is a non-modifiable (const) pointer stored in flash/constant space to a modifiable character stored in RAM
<code>int foo(const int x);</code>	Error - const not allowed for function parameters ^a	The parameter x is stored on the stack but is not modifiable within the function foo.
<code>int foo(char * str) { } const char * const s = "ABCD"; foo(s);</code>	OK, const property of variable s is ignored in function call ^a	Warning at function call - passing s to foo discards the const modifier of s

a. Variable initializers were introduced in Dynamic C 10.60, which changed some of the behavior for initialized variables. Other `const` changes are new with Dynamic C 10.64. The table primarily refers to the behavior prior to version 10.60.

4.5 Pointers to Functions, Indirect Calls

Pointers to functions may be declared. When a function is called using a pointer to it, instead of directly, we call this an *indirect* call. The syntax for declaring a pointer to a function is different than for ordinary pointers. Standard syntax for a pointer to a function is:

```
returntype (*name)( [argument list] );
```

for example:

```
int (*func1)(int a, int b);  
void (*func2)(char*);
```

You can pass arguments to functions that are called indirectly by pointers, and the compiler will check them for correctness if an argument list is provided in the function pointer declaration. This means that the auto promotions provided by Dynamic C type checking will automatically be applied. For example, if a function takes a long as a parameter, and you pass it a 16-bit integer value, it will be automatically cast to type long in order for 4 bytes to be put onto the stack, as would happen with a normal function call.

Prior to version 10.62, Dynamic C did not recognize the argument list in function pointer declarations and would generate an error. The syntax for the above examples would have looked like the following:

```
int (*func1)();  
void (*func2)();
```

Note that in ANSI C and Dynamic C 10.62 (and later) these statements use valid syntax that indicates that any parameters passed to the function pointers will *not* be type-checked, essentially providing a wild-card for the parameter list. Using this syntax is dangerous since it can lead to stack imbalances (passing a 16-bit integer to a function taking a 32-bit long, for example) and it should be used with great care.

It is advisable that function pointers in older Dynamic C programs be updated to use parameter lists to catch potential errors, but those programs will continue to compile without changes in Dynamic C 10.62 and later.

The following program shows some examples of using function pointers:

```
int intfunc(int x, int y);
typedef int (*fnptr)(int, int); // create pointer to function that returns an integer

main(){
    int x,y;
    int (*fnc1)(int, int);      // declare var fnc1 as a pointer to an int function
    fnptr fp2;                 // declare var fp2 as pointer to an int function
    fnc1 = intfunc;            // initialize fnc1 to point to intfunc()
    fp2 = intfunc;             // initialize fp2 to point to the same function
    x = (*fnc1)(1,2);          // call intfunc() via fnc1
    y = (*fp2)(3,4);           // call intfunc() via fp2
    printf("%d\n", x);
    printf("%d\n", y);
}

int intfunc(int x, int y){
    return x+y;
}
```

4.6 Function Chaining

Function chaining allows special segments of code to be distributed in one or more functions. When a named function chain executes, all the segments belonging to that chain execute. Function chains allow the software to perform initialization, data recovery, and other kinds of tasks on request. There are two directives, `#makechain` and `#funcchain`, and one keyword, `segchain` that create and control function chains:

#makechain chain_name

Creates a function chain. When a program executes the named function chain, all of the functions or chain segments belonging to that chain execute. (No particular order of execution can be guaranteed.)

#funcchain chain_name name

Adds a function, or another function chain, to a function chain.

segchain chain_name { statements }

Defines a program segment (enclosed in curly braces) and attaches it to the named function chain.

Function chain segments defined with `segchain` must appear in a function directly after data declarations and before executable statements, as shown below.

```
my_function(){
/* data declarations */
segchain chain_x{
/* some statements which execute under chain_x */
}
segchain chain_y{
/* some statements which execute under chain_y */
}
/* function body which executes when my_function is called */
}
```

A program will call a function chain as it would an ordinary void function that has no parameters. The following example shows how to call a function chain that is named `recover`.

```
#makechain recover
...
recover();
```

4.7 Global Initialization

Various hardware devices in a system need to be initialized, not only by setting variables and control registers, but often by complex initialization procedures. Dynamic C provides a specific function chain, `_GLOBAL_INIT`, for this purpose. Your program can add segments to the `_GLOBAL_INIT` function chain, as shown in the example below.

```
long my_func( char j );
main(){
my_func(100);
}

long my_func(char j){
static int i;
static long array[256];

// The GLOBAL_INIT section is automatically run once when the program starts up

#GLOBAL_INIT{
for( i = 0; i < 100; i++ ){
array[i] = i*i;
}
}

return array[j]; // only this code runs when the function is called
}
```

The special directive `#GLOBAL_INIT{ }` tells the compiler to add the code in the block enclosed in braces to the `_GLOBAL_INIT` function chain. Any number of `#GLOBAL_INIT` sections may be used in your code. The order in which they are called is indeterminate since it depends on the order in which they were compiled. The storage class for variables used in a global initialization section must be static. Since the default storage class is `auto`, you must define variables as `static` in your application.

The `_GLOBAL_INIT` function chain is always called when your program starts up, so there is nothing special to do to invoke it. In addition, it may be called explicitly at any time in an application program with the statement:

```
_GLOBAL_INIT();
```

Make this call this with caution. All costatements and cofunctions will be initialized. See [Section 7.2](#) for more information about calling `_GLOBAL_INIT()`.

4.8 Libraries

Dynamic C includes many libraries—files of useful functions in source code form. They are located in the \LIB directory where Dynamic C was installed. To support larger memories, some changes to the Dynamic C environment were made in version 10.21. One such change is that the \LIB directory now contains two separate directories, Rabbit2000_3000 and Rabbit4000. Each directory contains the same structure previously used by \LIB, but the libraries have been updated for the Rabbit 4000 processor in the \Lib\Rabbit4000 directory.

The default library file extension is “LIB”. Dynamic C uses functions and data from library files and compiles them with an application program that is then downloaded to a controller or saved to a .bin file.

An application program (the default file extension is .c) consists of a source code file that contains a main function (called main) and usually other user-defined functions. Any additional source files are considered to be libraries (though they may have a .c extension) and are treated as such. The minimum application program is one source file, containing only:

```
main() { }
```

Libraries (those defined by you and those defined by Rabbit) are “linked” with the application through the #use directive. The #use directive identifies a file from which functions and data may be extracted. Files identified by #use directives are nestable, as shown below.

Note that as of Dynamic C 10.60, the standard #include C construct can be used. In particular, this allows the organization of code into .c (code) and .h (header) files.

Figure 4.1 Nesting Files in Dynamic C

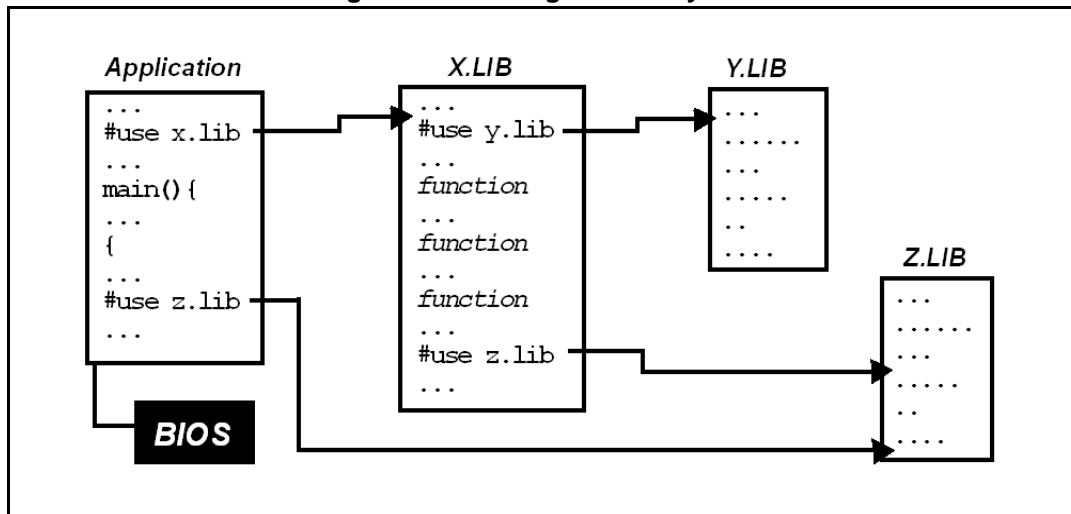

Most libraries needed by Dynamic C programs have #use statements in lib\..\default.h.

Section 4.10 explains how Dynamic C knows which functions and global variables in a library are available for use.

Note that as of Dynamic C 10.60, the standard #include C construct can be used. In particular, this allows the organization of code into .c (code) and .h (header) files.

4.8.1 Libraries and File Scope

Starting in Dynamic C 10.64, C files now each have their own scope. Previously, all C files and libraries shared the same global scope as the BIOS. The new scoping functionality places all symbols defined in the BIOS into the global scope, and each C file scope inherits the symbols from that scope. Libraries similarly inherit their scopes from the C files in which the first `#use` of that library is encountered. The library then has access to all the symbols defined in the global scope and all of the symbols defined in the enclosing C file scope. All symbols defined in the header sections in the `.LIB` file will be included in all files that `#use` that library. All symbols defined in the module bodies in the `.LIB` file will be added only to the first C file that is compiled that contains a `#use` of that library.

As an example, consider an application with the 3 files shown below: `File_1.C`, `File_2.C`, and `Lib_1.LIB`. Both C files contain the line `"#use Lib_1.LIB"`, but whichever C file is compiled first will define the file scope for `Lib_1.LIB`; in this case `File1.C` is compiled first. If a symbol is defined in `File_2.C` that is used by `Lib_1.LIB` (in this case the function `foo`), that symbol must be declared as `extern` in either `File_1.C` or in `Lib_1.LIB` and not be declared as `static` in `File_2.C`, even if the definition of that symbol comes before the `#use`. The symbols defined in the header sections of `Lib_1.LIB` are added to both C files, while the symbols defined in the module bodies in `Lib_1.LIB` are added only the scope of `File_1.C`.

```
// File1.C
#use "Lib1.LIB"
void main(void) { // main is visible in File1.C and Lib1.LIB, but
not File2.C
    global_var = 2; // From the module foo
    bar();
}

// File2.C
void foo(void) { ... } // Cannot be static
#use "Lib1.LIB" // foo is not visible in Lib1.LIB since Lib1.LIB
has the same scope as File1.C

// Lib1.LIB
/** BeginHeader bar */
extern void foo(void); // This is required for foo to be visible
within this LIB file
void bar(void);
/** EndHeader */

int global_var; // Visible within File1.C's scope, but not within
File2.C
void bar(void) { foo(); } // bar is in the same scope as main in
File1.C and not in the scope of File2.C
```

Note that the behavior of `#use` is different than that of `#include` since `#include` merely includes the same text (the contents of the `.H` file) in-line at the point of the `#include`.

4.8.2 LIB.DIR

Any library that is to be #use'd in a Dynamic C program must be listed in the file LIB.DIR, or another *.DIR file specified by the user. LIB.DIR is in the root directory of the Dynamic C installation.

The lib.dir strategy allows naming a folder with optional mask(s). Having no mask implies "*.*" and multiple masks are separated by ";" so that "lib" and "lib*.*" both include all files and "lib*.lib;*.c;*.h*" includes all files with extensions of .lib, .c and .h. Dynamic C generated files (e.g., .mdl, .hxl, etc.) are not parsed, which means they are excluded when using the wildcard mask.

Dynamic C enforces unique file extension names regardless of path, so that "#use myfile.lib" can not use an unintended copy of myfile.lib as the list of pathnames included in lib.dir is searched for the first occurrence of that file extension. An error message naming both full paths will come up when trying to compile ANY program alerting the user of the infraction.

A new feature introduced in Dynamic C10.21 is the ability to define masks that use exclusion criteria that will exclude specified folders and files from the "lib.dir" file. Such a lib.dir entry is just like a normal one except the it starts with ">", a character that Windows does not allow in a folder name. Once exclusions are defined, they persist throughout all entries that follow. To make this clear, look at the following examples of "lib.dir" entries:

Example 1:

The following "lib.dir" entries:

```
>CVS
Lib\Rabbit4000
Samples\*.Lib
```

excludes CVS folder trees throughout following entries, includes all files in Lib\Rabbit4000 and its subfolders (except for CVS subfolders), and includes all ".lib" files in Samples and its subfolders (except for CVS subfolders).

Thus, the ordering of the LIB.DIR entries is meaningful, as shown in the next example.

Example 2:

As dictated by the following three entries, the file Lib\Rabbit4000\BiosLib\Stdbios.c is excluded from LIB.DIR.

```
>*.c
Samples
Lib\Rabbit4000
```

Reordering the entries as shown below results in the file Lib\Rabbit4000\BiosLib\Stdbios.c being included in LIB.DIR.

```
Lib\Rabbit4000
>*.c
Samples
```

Example 3:

Dynamic C will not correctly process lines that include spaces:

```
\Lib\ MyLibs \*.Lib // WRONG, because of spaces in path
\Lib\MyLibs\*.Lib // CORRECT, spaces removed
```

4.9 Headers

The following table describes two kinds of headers used in Dynamic C libraries.

Table 4-2. Dynamic C Library Headers

Header Name	Description
Module headers	Make functions and global variables in the library known to Dynamic C.
Function Description headers	Describe functions. Function headers form the basis for function lookup help.

You may also notice some “Library Description” headers at the top of library files. These have no special meaning to Dynamic C, they are simply comment blocks.

4.10 Modules

A Dynamic C library typically contains several modules. Modules must be understood to write efficient custom libraries. Modules provide Dynamic C with the names of functions and variables within a library that may be referenced by files that have a `#use` directive for the library somewhere in the code.

Modules organize the library contents in such a way as to allow for smaller code size in the compiled application that uses the library. To create your own libraries, write modules following the guidelines in this section.

The scope of modules is global, but indeterminate compilation order makes the situation less than straightforward. Read this entire section carefully to understand module scope.

4.10.1 The Parts of a Module

A module has three parts: the key, the header, and the body. The structure of a module is:

```
/** BeginHeader func1, var2, .... */
prototype for func1
extern var2
/** EndHeader */
definition of func1
declaration for var2
possibly other functions and data
```

A module begins with its `BeginHeader` comment and continues until either the next `BeginHeader` comment or the end of the file is encountered.

4.10.1.1 Module Key

The module key is usually contained within the first line of the module header. It is a list of function and data names separated by commas. The list of names may continue on subsequent lines.

```
/** BeginHeader [name1, name2, ...] */
```

It is important to format the `BeginHeader` comment correctly, otherwise Dynamic C cannot find the contents of the module. The case of the word “beginheader” is unimportant, but it must be preceded by a forward slash, 3 asterisks and one space (`/**`). The forward slash must be the first character on the line. The `BeginHeader` comment must end with an asterisk and a forward slash (`*/`).

The key tells the compiler which functions exist in the module so the compiler can exclude the module if names in the key are not referenced. Data declarations (constants, structures, unions and variables) as well as macros and function chains (both `#makechain` and `#funchain` statements) do not need to be named in the key if they are completely defined in the header, i.e. no `extern` declaration. They are fully known to the compiler by being completely defined in the module header. An important thing to remember is that variables declared in a header section will be allocated memory space unless the declaration is preceded with `extern`.

4.10.1.2 Module Header

Every line between the `BeginHeader` and `EndHeader` comments belongs to the header of the module. When a library is linked to an application (i.e., the application has the statement: `#use “library_name”`), Dynamic C precompiles every header in the library, and only the headers.

With proper function prototypes and variable declarations, a module header ensures proper type checking throughout the application program. Prototypes, variables, structures, typedefs and macros declared in a header section will always be parsed by the compiler if the library is `#used`, and everything will have global scope.

It is even permissible to put function bodies in header sections, but it is not recommended for two reasons. First, because the function will be compiled with any application that `#uses` the library and since variables declared in a header section will be allocated memory space unless the declaration is preceded with `extern`, the variable declaration should be in the module body instead of the header to save data space. Second, auto (local) variables are not visible to the debugger when a function is defined (not prototyped) within a module header. This means that attempting to set a watch or evaluate expression on such a variable will result in an “out of scope / not declared” error or the variable’s stated value will not be correct.

The scope of anything inside the module header is global; this includes compiler directives. Since the headers are compiled before the module bodies, the last one of a given type of directive encountered will be in effect and any previous ones will be forgotten.

Using compiler directives like `#class` or `#memmap` inside module headers is inadvisable. If it is important to set, for example, “`#class auto`” for some library modules and “`#class static`” for others, the appropriate directives should be placed inside the module body, not in the module header. Furthermore, since there is no guaranteed compilation order and compiler directives have global scope, when you issue a compiler directive to change default behavior for a particular module, at the end of the module you should issue another compiler directive to change back to the default behavior. For example, if a module body needs to have its storage class as static, have a “`#class static`” directive at the beginning of the module body and “`#class auto`” at the end.

NOTE: The compiler directive “`#class static`” is deprecated starting with Dynamic C 10.44.

4.10.1.3 Module Body

Every line of code after the `EndHeader` comment belongs to the *body* of the module until (1) end-of-file or (2) the `BeginHeader` comment of another module. Dynamic C compiles the entire body of a module if *any* of the names in the key or header are referenced anywhere in the application. So keep modules small, don't put all the functions in a library into one module. If you look at the Dynamic C libraries you'll notice that many modules consist of one function. This saves on code size, because only the functions that are called are actually compiled into the application.

To further minimize waste, define code and data only in the body of a module. It is recommended that a module header contain only prototypes and `extern` declarations because they do not generate any code by themselves. That way, the compiler will generate code or allocate data *only* if the module is used by the application program.

4.10.2 Module Sample Code

There are many examples of modules in the `Lib` directory of Dynamic C. The following code will illustrate proper module syntax and show the scope of directives, functions and variables.

```
/**/ BeginHeader ticks*/
extern unsigned long ticks;
/**/ EndHeader */

unsigned long ticks;

/**/ BeginHeader Get_Ticks */
unsigned long Get_Ticks();
/**/ EndHeader */

unsigned long Get_Ticks(){
...
}

/**/ BeginHeader Inc_Ticks */
void Inc_Ticks( int i );
/**/ EndHeader */

#asm
Inc_Ticks::
or    a
ipset 1
...
ipres
ret
#endasm
```

There are three modules defined in this code. The first one is responsible for the variable `ticks`, the second and third modules define functions `Get_Ticks()` and `Inc_Ticks` that access the variable. Although `Inc_Ticks` is an assembly language routine, it has a function prototype in the module header, allowing the compiler to check calls to it.

If the application program calls `Inc_Ticks` or `Get_Ticks()` (or both), the module bodies corresponding to the called routines will be compiled. The compilation of these routines triggers compilation of the module body corresponding to `ticks` because the functions use the variable `ticks`.

```
/**/ BeginHeader func_a */
int func_a();
#ifdef SECONDHEADER
#define XYZ
#endif

/**/ EndHeader */

int func_a(){
#ifdef SECONDHEADER
printf ("I am function A.\n");
#endif
}

/**/ BeginHeader func_b */
int func_b();
#define SECONDHEADER

/**/ EndHeader */

#ifdef XYZ
#define FUNCTION_B
#endif

int func_b() {
#ifdef FUNCTION_B
printf ("I am function B.\n");
#endif
}
}
```

Let's say the above file is named `mylibrary.lib`. If an application has the statement `#use "mylibrary.lib"` and then calls `func_b()`, will the `printf` statement be reached? The answer is no. The order of compilation for module headers is sequential from the beginning of the file, therefore, the macro `SECONDHEADER` is undefined when the first module header is parsed.

If an application `#uses` this library and then makes a call to `func_a()`, will that function's print statement be reached? The answer is yes. Since all the headers were compiled first, the macro `SECONDHEADER` is defined when the first module body is compiled.

4.10.3 Important Notes

Remember that in a Dynamic C application there is only one file that contains `main()`. All other source files used by the file that contains `main()` are regarded as library files. Each library must be included in a `LIB.DIR` (or a user defined replacement for it). Although Dynamic C uses `.LIB` as the library extension, you may use anything you like as long as the complete path is entered in your `LIB.DIR` file.

There is no way to define file scope variables in Dynamic C libraries.

4.11 Function Description Headers

Each user-callable function in a Dynamic C library has a descriptive header preceding the function to describe the function. Function headers are extracted by Dynamic C to provide on-line help messages.

The header is a specially formatted comment, such as the following example.

```
/* START FUNCTION DESCRIPTION *****
WrIOport                <IO.LIB>
SYNTAX: void WrIOport(int portaddr, int value);
DESCRIPTION:
Writes data to the specified I/O port.
PARAMETER1: portaddr - register address of the port.
PARAMETER2: value - data to be written to the port.

RETURN VALUE: None
KEY WORDS: parallel port

SEE ALSO: RdIOport
END DESCRIPTION ***** /
```

If this format is followed, user-created library functions will show up in the [Function Lookup <Ctrl+H>](#) feature if the library is listed in `lib.dir` or its replacement. Note that these sections are scanned in when Dynamic C starts and changed libraries are rescanned with every Ctrl+H.

4.12 Support Files

Dynamic C has several support files that are necessary in building an application. These files are listed below.

Table 4-3. Dynamic C Support Files

File Name	Purpose of File
DCW.CFG	Contains configuration data for the target controller.
DC.HH	Contains prototypes, basic type definitions, <code>#define</code> , and default modes for Dynamic C. This file can be modified by the programmer.
DEFAULT.H	Contains a set of <code>#use</code> directives for each control product that Rabbit ships. This file can be modified.
LIB.DIR	Contains pathnames for all libraries that are to be known to Dynamic C. The programmer can add to, or remove libraries from this list. The factory default is for this file to contain all the libraries on the Dynamic C distribution disk. Any library that is to be used in a Dynamic C program must be listed in the file <code>LIB.DIR</code> , or another <code>*.DIR</code> file specified by the user.
PROJECT.DCP DEFAULT.DCP	These files hold the default compilation environment that is shipped from the factory. <code>DEFAULT.DCP</code> may be modified, but not <code>PROJECT.DCP</code> . See Chapter 18 for details on project files.

5. MULTITASKING WITH DYNAMIC C

In a multitasking environment, more than one task (each representing a sequence of operations) can *appear* to execute in parallel. In reality, a single processor can only execute one instruction at a time. If an application has multiple tasks to perform, multitasking software can usually take advantage of natural delays in each task to increase the overall performance of the system. Each task can do some of its work while the other tasks are waiting for an event, or for something to do. In this way, the tasks execute *almost* in parallel.

There are two types of multitasking available for developing applications in Dynamic C: *preemptive* and *cooperative*. In a cooperative multitasking environment, each well-behaved task voluntarily gives up control when it is waiting, allowing other tasks to execute. Dynamic C has language extensions, *costatements* and *cofunctions*, to support cooperative multitasking.

Preemptive multitasking is supported by the *slice* statement, which allows a computation to be divided into small slices of a few milliseconds each, and by the μ C/OS-II real-time kernel.

5.1 Cooperative Multitasking

In the absence of a preemptive multitasking kernel or operating system, a programmer given a real-time programming problem that involves running separate tasks on different time scales will often come up with a solution that can be described as a big loop driving state machines.

Figure 5.1 Big Loop

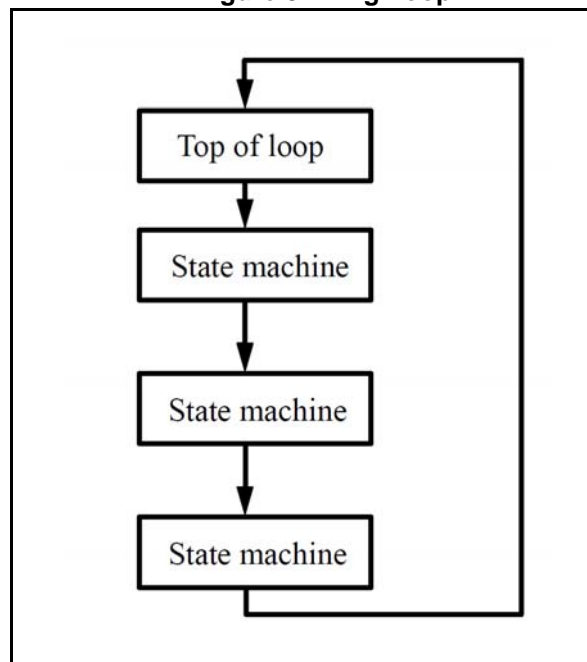

Within this endless loop, tasks are accomplished by small fragments of a program that cycle through a series of states. The state is typically encoded as numerical values in C variables.

State machines can become quite complicated, involving a large number of state variables and a large number of states. The advantage of the state machine is that it avoids busy waiting, which is waiting in a loop until a condition is satisfied. In this way, one big loop can service a large number of state machines, each performing its own task, and no one is busy waiting.

The cooperative multitasking language extensions added to Dynamic C use the big loop and state machine concept, but C code is used to implement the state machine rather than C variables. The state of a task is remembered by a statement pointer that records the place where execution of the block of statements has been paused to wait for an event.

To multitask using Dynamic C language extensions, most application programs will have some flavor of this simple structure:

```
main() {
  int i;
  while(1) {          // endless loop for multitasking framework
  costate {          // task 1
    . . .           // body of costatement
  }
  costate {          // task 2
    . . .           // body of costatement
  }
  }
}
```

5.2 A Real-Time Problem

The following sequence of events is common in real-time programming.

Start:

1. Wait for a push button to be pressed.
2. Turn on the first device.
3. Wait 60 seconds.
4. Turn on the second device.
5. Wait 60 seconds.
6. Turn off both devices.
7. Go back to the start.

The most rudimentary way to perform this function is to idle (“busy wait”) in a tight loop at each of the steps where waiting is specified. But most of the computer time will be used waiting for the task, leaving no execution time for other tasks.

5.2.1 Solving the Real-Time Problem with a State Machine

Here is what a state machine solution might look like.

```
tasklstate = 1; // initialization:
while(1){
    switch(tasklstate){
        case 1:
            if( buttonpushed() ){
                tasklstate=2;  turnondevice1();
                timer1 = time; // time incremented every second
            }
            break;
        case 2:
            if( (time-timer1) >= 60L){
                tasklstate=3;  turnondevice2();
                timer2=time;
            }
            break;
        case 3:
            if( (time-timer2) >= 60L){
                tasklstate=1;  turnoffdevice1();
                turnoffdevice2();
            }
            break;
    }
    /* other tasks or state machines */
}
```

If there are other tasks to be run, this control problem can be solved better by creating a loop that processes a number of tasks. Now each task can relinquish control when it is waiting, thereby allowing other tasks to proceed. Each task then does its work in the idle time of the other tasks.

5.3 Costatements

Costatements are Dynamic C extensions to the C language which simplify implementation of state machines. Costatements are cooperative because their execution can be voluntarily suspended and later resumed. The body of a costatement is an ordered list of operations to perform -- a task. Each costatement has its own statement pointer to keep track of which item on the list will be performed when the costatement is given a chance to run. As part of the startup initialization, the pointer is set to point to the first statement of the costatement.

The statement pointer is effectively a state variable for the costatement or cofunction. It specifies the statement where execution is to begin when the program execution thread hits the start of the costatement.

All costatements in the program, except those that use pointers as their names, are initialized when the function chain `_GLOBAL_INIT` is called. `_GLOBAL_INIT` is called automatically by `premain` before `main` is called. Calling `_GLOBAL_INIT` from an application program will cause reinitialization of anything that was initialized in the call made by `premain`.

5.3.1 Solving the Real-Time Problem with Costatements

The Dynamic C costatement provides an easier way to control the tasks. It is relatively easy to add a task that checks for the use of an emergency stop button and then behaves accordingly.

```
while(1){
    costate{ ... } // task 1

    costate{ // task 2
        waitFor( buttonpushed() );
        turnondevice1();
        waitFor( DelaySec(60L) );
        turnondevice2();
        waitFor( DelaySec(60L) );
        turnoffdevice1();
        turnoffdevice2();
    }
    costate{ ... } // task n
}
```

The solution is elegant and simple. Note that the second costatement looks much like the original description of the problem. All the branching, nesting and variables within the task are hidden in the implementation of the costatement and its `waitFor` statements.

5.3.2 Costatement Syntax

The keyword `costate` identifies the statements enclosed in the curly braces that follow as a costatement.

```
costate [ name [state] ] { [ statement | yield; | abort; | waitFor(
    expression ); ] . . . }
```

name can be one of the following:

- A valid C name not previously used. This results in the creation of a structure of type `CoData` of the same name.
- The name of a local or global `CoData` structure that has already been defined
- A pointer to an existing structure of type `CoData`

Costatements can be named or unnamed. If name is absent the compiler creates an unnamed structure of type `CoData` for the costatement.

state can be one of the following:

- **always_on**

The costatement is always active. This means the costatement will execute every time it is encountered in the execution thread, unless it is made inactive by `CoPause()`. It may be made active again by `CoResume()`.

- `init_on`

The costatement is initially active and will automatically execute the first time it is encountered in the execution thread. The costatement becomes inactive after it completes (or aborts). The costatement can be made inactive by `CoPause()`.

If `state` is absent, a named costatement is initialized in a paused `init_on` condition. This means that the costatement will not execute until `CoBegin()` or `CoResume()` is executed. It will then execute once and become inactive again.

Unnamed costatements are `always_on`. You cannot specify `init_on` without specifying a costatement name.

5.3.3 Control Statements

This section describes the control statements identified by the keywords: `waitfor`, `yield` and `abort`.

`waitfor (expression);`

The keyword `waitfor` indicates a special `waitfor` statement and not a function call. Each time `waitfor` is executed, *expression* is evaluated. If true (non-zero), execution proceeds to the next statement; otherwise a jump is made to the closing brace of the costatement or cofunction, with the statement pointer continuing to point to the `waitfor` statement. Any valid C function that returns a value can be used in a `waitfor` statement.

Figure 5.2 shows the execution thread through a costatement when a `waitfor` evaluates to false. The diagram on the left side shows which statements are executed the first time through the costatement. The diagram on the right shows that when the execution thread again reaches the costatement the only statement executed is the `waitfor`. As long as the `waitfor` continues to evaluate to false, it will be the only statement executed within the costatement.

Figure 5.2 Execution thread when `waitfor` evaluates to false

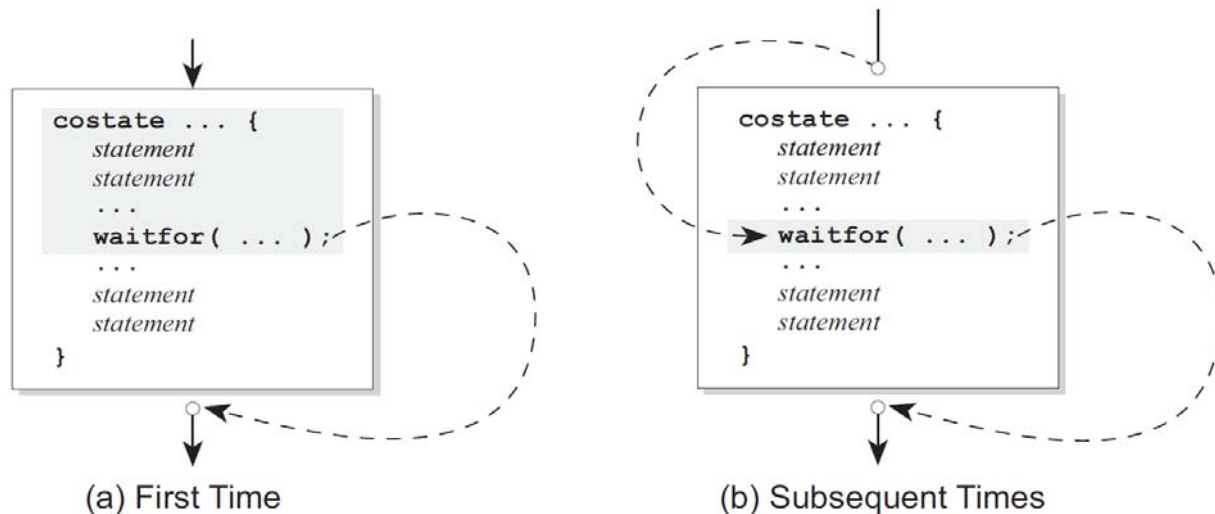
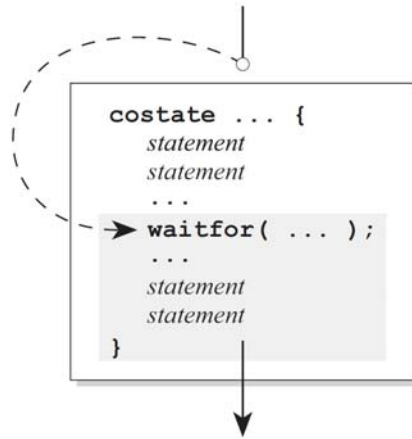

Figure 5.3 shows the execution thread through a costatement when a `waitfor` evaluates to true.

Figure 5.3 Execution thread when `waitfor` evaluates to true



yield

The `yield` statement makes an unconditional exit from a costatement or a cofunction. Execution continues at the statement following `yield` the next time the costatement or cofunction is encountered by the execution thread.

Figure 5.4 Execution thread with `yield` statement

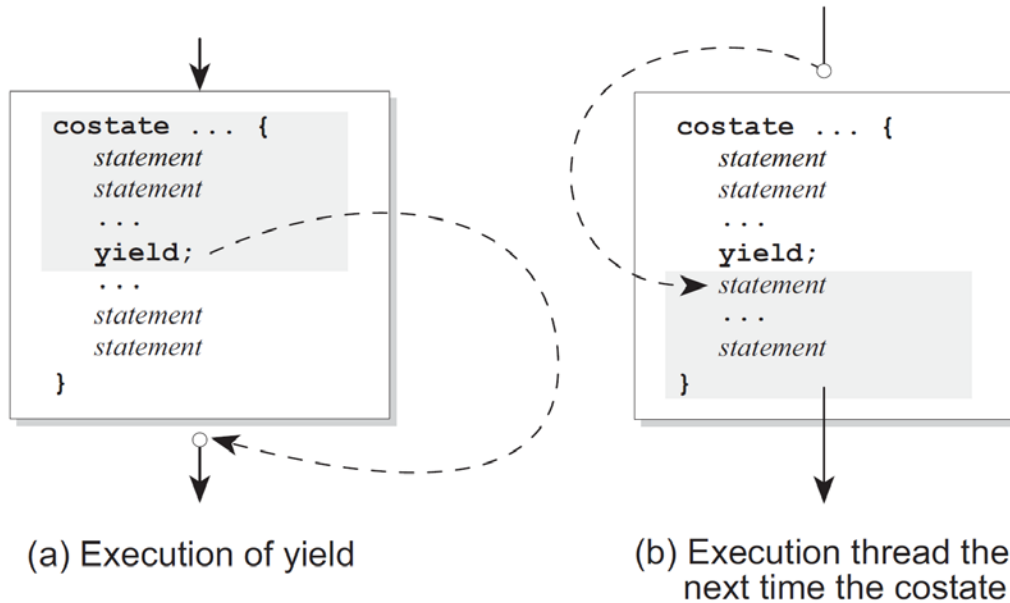

abort

The `abort` statement causes the costatement or cofunction to terminate execution. If a costatement is `always_on`, the next time the program reaches it, it will restart from the top. If the costatement is not `always_on`, it becomes inactive and will not execute again until turned on by some other software.

Figure 5.5 Execution thread with abort statement

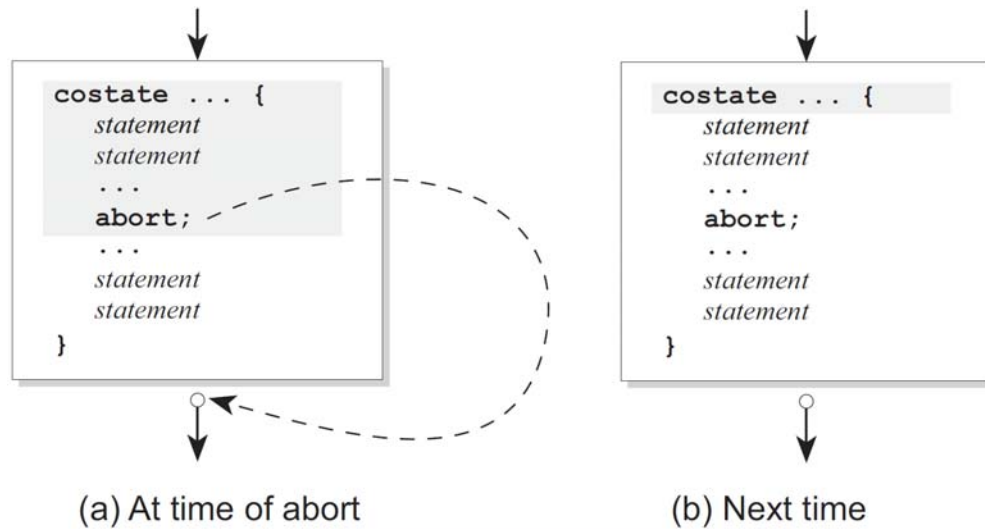

A costatement can have as many C statements, including `abort`, `yield`, and `waitfor` statements, as needed. Costatements can be nested.

5.4 Advanced Costatement Topics

Each costatement has a structure of type `CoData`. This structure contains state and timing information. It also contains the address inside the costatement that will execute the next time the program thread reaches the costatement. A value of zero in the address location indicates the beginning of the costatement.

5.4.1 The CoData Structure

```
typedef struct {
    char CSState;
    unsigned int lastlocADDR;
    char lastlocCBR;
    char ChkSum;
    char firsttime;
    union{
        unsigned long ul;
        struct {
            unsigned int u1;
            unsigned int u2;
        } us;
    } content;
    char ChkSum2;
} CoData;
```

5.4.2 CoData Fields

This section describes the fields of the CoData structure.

CSState

The `CSState` field contains two flags, `STOPPED` and `INIT`. The possible flag values and their meaning are in the table below.

Table 5-1. Flags that Specify the Run Status of a Costatement

STOPPED	INIT	State of Costatement
yes	yes	Done, or has been initialized to run, but set to inactive. Set by <code>CoReset()</code> .
yes	no	Paused, waiting to resume. Set by <code>CoPause()</code> .
no	yes	Initialized to run. Set by <code>CoBegin()</code> .
no	no	Running. <code>CoResume()</code> will return the flags to this state.

The function `isCoDone()` returns true (1) if both the `STOPPED` and `INIT` flags are set. The function `isCoRunning()` returns true (1) if the `STOPPED` flag is not set.

The `CSState` field applies only if the costatement has a name. The `CSState` flag has no meaning for unnamed costatements or cofunctions.

Last Location

The two fields `lastlocADDR` and `lastlocCBR` represent the 24-bit address of the location at which to resume execution of the costatement. If `lastlocADDR` is zero (as it is when initialized), the costatement executes from the beginning, subject to the `CSState` flag. If `lastlocADDR` is nonzero, the costatement resumes at the 24-bit address represented by `lastlocADDR` and `lastlocCBR`.

These fields are zeroed whenever one of the following is true:

- the `CoData` structure is initialized by a call to `_GLOBAL_INIT`, `CoBegin` or `CoReset`
- the costatement is executed to completion
- the costatement is aborted.

Check Sum

The `ChkSum` field is a one-byte check sum of the address. (It is the exclusive-or result of the bytes in `lastlocADDR` and `lastlocCBR`.) If `ChkSum` is not consistent with the address, the program will generate a run-time error and reset. The check sum is maintained automatically. It is initialized by `_GLOBAL_INIT`, `CoBegin` and `CoReset`.

First Time

The `firsttime` field is a flag that is used by a `waitfor`, or `waitfordone` statement. It is set to 1 before the statement is evaluated the first time. This aids in calculating elapsed time for the functions `DelayMs`, `DelaySec`, `DelayTicks`, `IntervalTick`, `IntervalMs`, and `IntervalSec`.

Content

The `content` field (a union) is used by the `costatement` or `cofunction` delay routines to store a delay count.

Check Sum 2

The `ChkSum2` field is currently unused.

5.4.3 Pointer to CoData Structure

To obtain a pointer to a named `costatement`'s `CoData` structure, do the following:

```
static CoData    cost1;           // allocate memory for a CoData struct
static CoData    *pcost1;
pcost1 = &cost1;                 // get pointer to the CoData struct
...
CoBegin (pcost1);                // initialize CoData struct
costate pcost1 {                 // pcost1 is the costatement name and also a
    ...                           // pointer to its CoData structure.
}
```

The storage class of a named `CoData` structure must be `static`.

5.4.4 Functions for Use With Named Costatements

For detailed function descriptions, please see the *Dynamic C Function Reference Manual* or select `Function Lookup/Insert` from `Dynamic C's Help` menu (keyboard shortcut is <Ctrl-H>).

All of these functions are in `COSTATE.LIB`. Each one takes a pointer to a `CoData` struct as its only parameter.

int isCoDone(CoData* p);

This function returns true if the `costatement` pointed to by `p` is initialized and not running.

int isCoRunning(CoData* p);

This function returns true if the `costatement` pointed to by `p` will run if given a continuation call.

void CoBegin(CoData* p);

This function initializes a `costatement`'s `CoData` structure so that the `costatement` will be executed next time it is encountered.

void CoPause(CoData* p);

This function will change `CoData` so that the associated `costatement` is paused. When a `costatement` is called in this state it does an implicit yield until it is released by a call from `CoResume` or `CoBegin`.

void CoReset(CoData* p);

This function initializes a `costatement`'s `CoData` structure so that the `costatement` will not be executed the next time it is encountered.

void CoResume(CoData* p);

This function unpauses a paused `costatement`. The `costatement` resumes the next time it is called.

5.4.5 Firsttime Functions

In a function definition, the keyword `firsttime` causes the function to have an implicit first parameter: a pointer to the CoData structure of the costatement that calls it. User-defined `firsttime` functions are allowed.

The following `firsttime` functions are defined in `COSTATE.LIB`.

```
DelayMs(), DelaySec(), DelayTicks()  
IntervalMs(), IntervalSec(), IntervalTick()
```

For more information see the *Dynamic C Function Reference Manual*. These functions should be called inside a `waitfor` statement because they do not yield while waiting for the desired time to elapse, but instead return 0 to indicate that the desired time has not yet elapsed.

5.4.6 Shared Global Variables

The variables `SEC_TIMER`, `MS_TIMER` and `TICK_TIMER` are shared, making them atomic when being updated. They are defined and initialized in `VDRIVER.LIB`. They are updated by the periodic interrupt and are used by `firsttime` functions. They should not be modified by an application program. Costatements and cofunctions depend on these timer variables being valid for use in `waitfor` statements that call functions that read them. For example, the following statement will access `SEC_TIMER`.

```
waitfor(DelaySec(3));
```

5.5 Cofunctions

Cofunctions, like costatements, are used to implement cooperative multitasking. But, unlike costatements, they have a form similar to functions in that arguments can be passed to them and a value can be returned (but not a structure).

The default storage class for a cofunction's variables is `Instance`. An `instance` variable behaves like a `static` variable, i.e., its value persists between function calls. Each instance of an [Indexed Cofunction](#) has its own set of instance variables. The compiler directive `#class` does not change the default storage class for a cofunction's variables.

All cofunctions in the program are initialized when the function chain `_GLOBAL_INIT` is called. This call is made by `premain`.

5.5.1 Cofunction Syntax

A cofunction definition is similar to the definition of a C function.

```
cofunc|scofunc type [name][[dim]]([type arg1, ..., type argN])  
    { [ statement | yield; | abort; | waitfor(expression); ]... }
```

cofunc, scofunc

The keywords `cofunc` or `scofunc` (a single-user cofunction) identify the statements enclosed in curly braces that follow as a cofunction.

type

Whichever keyword (`cofunc` or `scofunc`) is used is followed by the data type returned (`void`, `int`, etc.).

name

A name can be any valid C name not previously used. This results in the creation of a structure of type `CoData` of the same name.

dim

The cofunction name may be followed by a dimension if an indexed cofunction is being defined.

cofunction arguments (arg1, . . . , argN)

As with other Dynamic C functions, cofunction arguments are passed by value.

cofunction body

A cofunction can have as many C statements, including `abort`, `yield`, `waitfor`, and `waitfordone` statements, as needed. Cofunctions can contain calls to other cofunctions.

5.5.2 Calling Restrictions

You cannot assign a cofunction to a function pointer then call it via the pointer.

Cofunctions are called using a `waitfordone` statement. Cofunctions and the `waitfordone` statement may return an argument value as in the following example.

```
int j,k,x,y,z;  
j = waitfordone x = Cofunc1;  
k = waitfordone{ y=Cofunc2(...); z=Cofunc3(...); }
```

The keyword `waitfordone` (can be abbreviated to the keyword `wfd`) must be inside a `costatement` or cofunction. Since a cofunction must be called from inside a `wfd` statement, ultimately a `wfd` statement must be inside a `costatement`. If only one cofunction is being called by `wfd` the curly braces are not needed.

The `wfd` statement executes cofunctions and `firsttime` functions. When all the cofunctions and `firsttime` functions listed in the `wfd` statement are complete (or one of them aborts), execution proceeds to the statement following `wfd`. Otherwise a jump is made to the ending brace of the `costatement` or

cofunction where the `wfd` statement appears and when the execution thread comes around again control is given back to `wfd`.

In the example above, `x`, `y` and `z` must be set by `return` statements inside the called cofunctions. Executing a `return` statement in a cofunction has the same effect as executing the end brace. In the example above, the variable `k` is a status variable that is set according to the following scheme. If no abort has taken place in any cofunction, `k` is set to 1, 2, ..., `n` to indicate which cofunction inside the braces finished executing last. If an abort takes place, `k` is set to -1, -2, ..., -`n` to indicate which cofunction caused the abort.

5.5.2.1 Cofunctions and Return Statements

More than one `return` statement in a cofunction will result in unpredictable behavior.

5.5.2.2 Costate Within a Cofunc

In all but trivial cases (where the `costate` is really not necessary), a `costate` within a cofunc causes execution problems ranging from never completing the cofunc to unexpected interrupts or target lockups. To avoid these problems, do not introduce `costates` with nested `wfd` cofuncs into a cofunc. If you find yourself coding such a thing, consider these alternatives:

1. Intermediate regular functions can be used between the cofuncs to isolate them.
2. A regular `waitfor(function)` can be substituted for the top level `costate`'s `wfd` cofunction.
3. The nested `costates` with `wfd` cofuncs can be moved up into the body of the calling function, replacing the top-level `costate` with the `wfd` cofunc.

A compiler error will be generated if a `costate` is found within a cofunction.

5.5.2.3 Using the IX Register

Functions called from within a cofunction may use the `IX` register if they restore it before the cofunction is exited, which includes an exit via an incomplete `waitfordone` statement.

In the case of an application that uses the `#useix` directive, the `IX` register will be corrupted when any stack-variable using function is called from within a cofunction, or if a stack-variable using function contains a call to a cofunction.

5.5.3 CoData Structure

The `CoData` structure discussed in [Section 5.4.1](#) applies to cofunctions; each cofunction has an associated `CoData` structure.

5.5.4 Firsttime Functions

The `firsttime` functions discussed in [“Firsttime Functions” on page 50](#) can also be used inside cofunctions. They should be called inside a `waitfor` statement. If you call these functions from inside a `wfd` statement, no compiler error is generated, but, since these delay functions do not yield while waiting for the desired time to elapse, but instead return 0 to indicate that the desired time has not yet elapsed, the `wfd` statement will consider a return value to be completion of the `firsttime` function and control will pass to the statement following the `wfd`.

5.5.5 Types of Cofunctions

There are three types of cofunctions: simple, indexed and single-user. Which one to use depends on the problem that is being solved. A single-user, indexed cofunction is not valid.

5.5.5.1 Simple Cofunction

A simple cofunction has only one instance and is similar to a regular function with a `costate` taking up most of the function's body.

5.5.5.2 Indexed Cofunction

An indexed cofunction allows the body of a cofunction to be called more than once with different parameters and local variables. The parameters and the local variable that are not declared static have a special lifetime that begins at a first time call of a cofunction instance and ends when the last curly brace of the cofunction is reached or when an `abort` or `return` is encountered.

The indexed cofunction call is a cross between an array access and a normal function call, where the array access selects the specific instance to be run.

Typically this type of cofunction is used in a situation where N identical units need to be controlled by the same algorithm. For example, a program to control the door latches in a building could use indexed cofunctions. The same cofunction code would read the key pad at each door, compare the passcode to the approved list, and operate the door latch. If there are 25 doors in the building, then the indexed cofunction would use an index ranging from 0 to 24 to keep track of which door is currently being tested. An indexed cofunction has an index similar to an array index.

```
waitfordone{ ICofunc[n](...); ICofunc2[m](...); }
```

The value between the square brackets must be positive and less than the maximum number of instances for that cofunction. There is no runtime checking on the instance selected, so, like arrays, the programmer is responsible for keeping this value in the proper range.

NOTE: Costatements are not supported inside indexed cofunctions. Single user cofunctions cannot be indexed.

5.5.5.3 Single User Cofunction

Since cofunctions are executing in parallel, the same cofunction normally cannot be called at the same time from two places in the same big loop. For example, the following statement containing two simple cofunctions will generally cause a fatal error.

```
waitfordone{ cofunc_nameA(); cofunc_nameA(); }
```

This is because the same cofunction is being called from the second location after it has already started, but not completed, execution for the call from the first location. The cofunction is a state machine and it has an internal statement pointer that cannot point to two statements at the same time.

Single-user cofunctions can be used instead. They can be called simultaneously because the second and additional callers are made to wait until the first call completes. The following statement, which contains two calls to single-user cofunction, is okay.

```
waitfordone( scofunc_nameA(); scofunc_nameA(); )
```

loopinit()

This function should be called in the beginning of a program that uses single-user cofunctions. It initializes internal data structures that are used by `loophead()`.

loophead()

This function should be called within the “big loop” in your program. It is necessary for proper single-user cofunction abandonment handling.

Example

```
// echoes characters
main() {
    int c;
    serAopen(19200);
    loopinit();
    while (1) {
        loophead();
        costate {
            wfd c = cof_serAgetc();
            wfd cof_serAputc(c);
        }
    }
    serAclose();
}
```

5.5.6 Types of Cofunction Calls

A `wfd` statement makes one of three types of calls to a cofunction.

5.5.6.1 First Time Call

A first time call happens when a `wfd` statement calls a cofunction for the first time in that statement. After the first time, only the original `wfd` statement can give this cofunction instance continuation calls until either the instance is complete or until the instance is given another first time call from a different statement. The lifetime of a cofunction instance stretches from a first time call until its terminal call or until its next first time call.

5.5.6.2 Continuation Call

A continuation call is when a cofunction that has previously yielded is given another chance to run by the enclosing `wfd` statement. These statements can only call the cofunction if it was the last statement to give the cofunction a first time call or a continuation call.

5.5.6.3 Terminal Call

A terminal call ends with a cofunction returning to its `wfd` statement without yielding to another cofunction. This can happen when it reaches the end of the cofunction and does an implicit return, when the cofunction does an explicit return, or when the cofunction aborts.

5.5.7 Special Code Blocks

The following special code blocks can appear inside a cofunction.

everytime { *statements* }

This must be the first statement in the cofunction. The everytime statement block will be executed on every `cofunc` continuation call no matter where the statement pointer is pointing. After the everytime statement block is executed, control will pass to the statement pointed to by the cofunction's statement pointer.

The everytime statement block will not be executed during the initial `cofunc` entry call.

abandon { *statements* }

This keyword applies to single-user cofunctions only and must be the first statement in the body of the cofunction. The statements inside the curly braces will be executed if the single-user cofunction is forcibly abandoned. A call to `loophead()` (defined in `COFUNC.LIB`) is necessary for abandon statements to execute.

Example

`Samples/COFUNC/COFABAND.C` illustrates the use of `abandon`.

```
scofunc SCofTest(int i){
  abandon {
    printf("CofTest was abandoned\n");
  }
  while(i>0) {
    printf("CofTest(%d)\n",i);
    yield;
  }
}

main(){
  int x;
  for(x=0;x<=10;x++) {
    loophead();
    if(x<5) {
      costate {
        wfd SCofTest(1);           // first caller
      }
    }
    costate {
      wfd SCofTest(2);           // second caller
    }
  }
}
```

In this example two tasks in `main()` are requesting access to `SCofTest`. The first request is honored and the second request is held. When `loophead()` notices that the first caller is not being called each time around the loop, it cancels the request, calls the abandonment code and allows the second caller in.

5.5.8 Solving the Real-Time Problem with Cofunctions

Cofunctions, with their ability to receive arguments and return values, provide more flexibility and specificity than our previous solutions.

```
for(;;){
  costate{                                     // task 1
  wfd emergencystop();
  for (i=0; i<MAX_DEVICES; i++)
  wfd turnoffdevice(i);
  }

  costate{                                     // task 2
  wfd x = buttonpushed();
  wfd turnondevice(x);
  waitfor( DelaySec(60L) );
  wfd turnoffdevice(x);
  }
  ...
  costate{ ... }                               // task n
}
```

Using cofunctions, new machines can be added with only trivial code changes. Making `buttonpushed()` a cofunction allows more specificity because the value returned can indicate a particular button in an array of buttons. Then that value can be passed as an argument to the cofunctions `turnondevice` and `turnoffdevice`.

5.6 Patterns of Cooperative Multitasking

Sometimes a task may be something that has a beginning and an end. For example, a cofunction to transmit a string of characters via the serial port begins when the cofunction is first called, and continues during successive calls as control cycles around the big loop. The end occurs after the last character has been sent and the `waitfordone` condition is satisfied. This type of a call to a cofunction might look like this:

```
waitfordone{ SendSerial("string of characters"); }
[ next statement ]
```

The next statement will execute after the last character is sent.

Some tasks may not have an end. They are endless loops. For example, a task to control a servo loop may run continuously to regulate the temperature in an oven. If there are a number of tasks that need to run continuously, then they can be called using a single `waitfordone` statement as shown below.

```
costate {
  waitfordone { Task1(); Task2(); Task3(); Task4(); }
  [ to come here is an error ]
}
```

Each task will receive some execution time and, assuming none of the tasks is completed, they will continue to be called. If one of the cofunctions should abort, then the `waitfordone` statement will abort, and corrective action can be taken.

5.7 Timing Considerations

In most instances, costatements and cofunctions are grouped as periodically executed tasks. They can be part of a real-time task, which executes every n milliseconds as shown below using costatements.

Figure 5.6 Costatement as Part of Real-Time Task

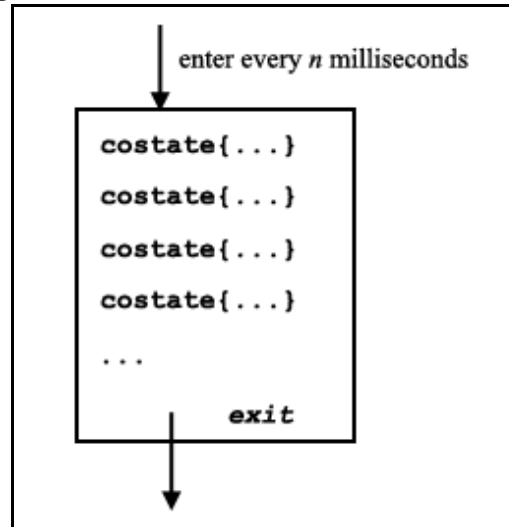

If all goes well, the first costatement will be executed at the periodic rate. The second costatement will, however, be delayed by the first costatement. The third will be delayed by the second, and so on. The frequency of the routine and the time it takes to execute comprise the granularity of the routine.

If the routine executes every 25 milliseconds and the entire group of costatements executes in 5 to 10 milliseconds, then the granularity is 30 to 35 milliseconds. Therefore, the delay between the occurrence of a `waitfor` event and the statement following the `waitfor` can be as much as the granularity, 30 to 35 ms. The routine may also be interrupted by higher priority tasks or interrupt routines, increasing the variation in delay.

The consequences of such variations in the time between steps depends on the program's objective. Suppose that the typical delay between an event and the controller's response to the event is 25 ms, but under unusual circumstances the delay may reach 50 ms. An occasional slow response may have no consequences whatsoever. If a delay is added between the steps of a process where the time scale is measured in seconds, then the result may be a very slight reduction in throughput.

If there is a delay between sensing a defective product on a moving belt and activating the reject solenoid that pushes the object into the reject bin, the delay could be serious. If a critical delay cannot exceed 40 ms, then a system will sometimes fail if its worst-case delay is 50 ms.

5.7.1 `waitfor` Accuracy Limits

If an idle loop is used to implement a delay, the processor continues to execute statements almost immediately (within nanoseconds) after the delay has expired. In other words, idle loops give precise delays. Such precision cannot be achieved with `waitfor` delays.

A particular application may not need very precise delay timing. Suppose the application requires a 60-second delay with only 100 ms of delay accuracy; that is, an actual delay of 60.1 seconds is considered acceptable. Then, if the processor guarantees to check the delay every 50 ms, the delay would be at most 60.05 seconds, and the accuracy requirement is satisfied.

5.8 Overview of Preemptive Multitasking

In a preemptive multitasking environment, tasks do not voluntarily relinquish control. Tasks are scheduled to run by priority level and/or by being given a certain amount of time.

There are two ways to accomplish preemptive multitasking using Dynamic C. The first way is via a Dynamic C construct called the “slice” statement (described in [Section 5.9](#)). The second way is μ C/OS-II, a real-time, preemptive kernel that runs on the Rabbit microprocessor and is fully supported by Dynamic C (described in [Section 5.10](#)).

5.9 Slice Statements

The `slice` statement, based on the `costatement` language construct, allows the programmer to run a block of code for a specific amount of time.

5.9.1 Slice Syntax

```
slice ([context_buffer,] context_buffer_size, time_slice)
    [name]{[statement | yield; | abort; | waitfor(expression);]}
```

context_buffer_size

This value must evaluate to a constant integer. The value specifies the number of bytes for the buffer `context_buffer`. It needs to be large enough for worst-case stack usage by the user program and interrupt routines.

time_slice

The amount of time in ticks for the slice to run. One tick = 1/1024 second.

name

When defining a named `slice` statement, you supply a context buffer as the first argument. When you define an unnamed `slice` statement, this structure is allocated by the compiler.

```
[statement | yield; | abort; | waitfor(expression);]
```

The body of a `slice` statement may contain:

- Regular C statements
- `yield` statements to make an unconditional exit.
- `abort` statements to make an execution jump to the very end of the statement.
- `waitfor` statements to suspend progress of the slice statement pending some condition indicated by the expression.

5.9.2 Usage

The `slice` statement can run both cooperatively and preemptively all in the same framework. A `slice` statement, like `costatements` and `cofunctions`, can suspend its execution with an `abort`, `yield`, or `waitfor`. It can also suspend execution with an implicit `yield` determined by the `time_slice` parameter that was passed to it. A routine called from the periodic interrupt forms the basis for scheduling `slice` statements. It counts down the ticks and changes the `slice` statement's context.

5.9.3 Restrictions

Since a `slice` statement has its own stack, local auto variables and parameters cannot be accessed while in the context of a `slice` statement. Any function called from the `slice` statement performs normally.

Only one `slice` statement can be active at any time, which eliminates the possibility of nesting `slice` statements or using a `slice` statement inside a function that is either directly or indirectly called from a `slice` statement. The only methods supported for leaving a `slice` statement are completely executing the last statement in the `slice`, or executing an `abort`, `yield` or `waitfor` statement.

The `return`, `continue`, `break`, and `goto` statements are not supported.

`Slice` statements cannot be used with μ C/OS-II or TCP/IP.

5.9.4 Slice Data Structure

Internally, the `slice` statement uses two structures to operate. When defining a named `slice` statement, you supply a context buffer as the first argument. When you define an unnamed `slice` statement, this structure is allocated by the compiler. Internally, the context buffer is represented by the `SliceBuffer` structure below.

```
struct SliceData {
    int time_out;
    void* my_sp;
    void* caller_sp;
    CoData codata;
}

struct SliceBuffer {
    SliceData slice_data;
    char stack[];           // fills rest of the slice buffer
};
```

5.9.5 Slice Internals

When a `slice` statement is given control, it saves the current context and switches to a context associated with the `slice` statement. After that, the driving force behind the `slice` statement is the timer interrupt. Each time the timer interrupt is called, it checks to see if a `slice` statement is active. If a `slice` statement is active, the timer interrupt decrements the `time_out` field in the `slice`'s `SliceData`. When the field is decremented to zero, the timer interrupt saves the `slice` statement's context into the `SliceBuffer` and restores the previous context. Once the timer interrupt completes, the flow of control is passed to the statement directly following the `slice` statement. A similar set of events takes place when the `slice` statement does an explicit `yield/abort/waitfor`.

Example 1

Two `slice` statements and a `costate` will appear to run in parallel. Each block will run independently, but the `slice` statement blocks will suspend their operation after 20 ticks for `slice_a` and 40 ticks for `slice_b`. `Costate a` will not release control until it either explicitly yields, aborts, or completes. In contrast, `slice_a` will run for at most 20 ticks, then `slice_b` will begin running. `Costate a` will get its next opportunity to run about 60 ticks after it relinquishes control.

```
main () {
    int x, y, z;
    ...
    for (;;) {
        costate a {
            ...
        }
        slice(500, 20) {          // slice_a
            ...
        }
        slice(500, 40) {        // slice_b
            ...
        }
    }
}
```

Example 2

This code guarantees that the first slice starts on `TICK_TIMER` evenly divisible by 80 and the second starts on `TICK_TIMER` evenly divisible by 105.

```
main() {
    for(;;) {
        costate {
            slice(500,20) {          // slice_a
                waitFor(IntervalTick(80));
                ...
            }
            slice(500,50) {          // slice_b
                waitFor(IntervalTick(105));
                ...
            }
        }
    }
}
```

Example 3

This approach is more complicated, but will allow you to spend the idle time doing a low-priority background task.

```
main() {
    int time_left;
    long start_time;
    for(;;) {
        start_time = TICK_TIMER;
        slice(500,20) { // slice_a
            waitfor(IntervalTick(80));
            ...
        }
        slice(500,50) { // slice_b
            waitfor(IntervalTick(105));
            ...
        }
        time_left = 75-(TICK_TIMER-start_time);
        if(time_left>0) {
            slice(500,75-(TICK_TIMER-start_time)) { // slice_c
                ...
            }
        }
    }
}
```

5.10 μ C/OS-II

μ C/OS-II is a simple, clean, efficient, easy-to-use real-time operating system that runs on the Rabbit microprocessor and is fully supported by the Dynamic C development environment. With Dynamic C, there is no fee to pay for the “Object Code Distribution License” that is usually required for embedding μ C/OS-II in a product.

μ C/OS-II is capable of intertask communication and synchronization via the use of semaphores, mailboxes, and queues. User-definable system hooks are supplied for added system and configuration control during task creation, task deletion, context switches, and time ticks.

For more information on μ C/OS-II, please refer to Jean J. Labrosse’s book, *MicroC/OS-II, The Real-Time Kernel* (ISBN: 0-87930-543-6). The data structures (e.g., Event Control Block) referenced in the Dynamic C μ C/OS-II function descriptions are fully explained in Labrosse’s book, available for purchase at:

www.rabbit.com/store/

<http://www.ucos-ii.com/>

The Dynamic C version of μ C/OS-II has the new features and API changes available in version 2.51 of μ C/OS-II. The documentation for these changes will be in the `/Samples/UCos-II` directory. The file `Newv251.pdf` contains all of the features added since version 2.00 and `Relv251.pdf` contains release notes for version 2.51.

The remainder of this section discusses the following:

- Dynamic C enhancements to μ C/OS-II
- Tasking aware ISRs
- Dynamic C library reentrancy
- How to get a μ C/OS-II application running
- TCP/IP compatibility
- API function descriptions
- Debugging tips

5.10.1 Changes to μ C/OS-II

Minor changes have been made to μ C/OS-II to take full advantage of services provided by Dynamic C.

5.10.1.1 Ticks per Second

In most implementations of μ C/OS-II, `OS_TICKS_PER_SEC` informs the operating system of the rate at which `OSTimeTick` is called; this macro is used as a constant to match the rate of the periodic interrupt. In μ C/OS-II for the Rabbit, however, changing this macro will *change* the tick rate of the operating system set up during `OSInit`. Usually, a real-time operating system has a tick rate of 10 Hz to 100 Hz, or 10–100 ticks per second. Since the periodic interrupt on the Rabbit occurs at a rate of 2 kHz, it is recommended that the tick rate be a power of 2 (e.g., 16, 32, or 64).

Keep in mind that the higher the tick rate, the more overhead the system will incur. It is possible to set the value of `OS_TICKS_PER_SECOND` so high that task switching becomes the predominant operation leaving too little time for the user processes to run properly. The only way to determine if your value is too high is to see if your tasks run properly at a lower value.

In the Rabbit version of μ C/OS-II, the number of ticks per second defaults to 64. The actual number of ticks per second may be slightly different than the desired ticks per second if `TicksPerSec` does not evenly divide 2048.

Changing the default tick rate is done by simply defining `OS_TICKS_PER_SEC` to the desired tick rate before calling `OSInit()`. For example, to change the tick rate to 32 ticks per second:

```
#define OS_TICKS_PER_SEC 32
...
OSInit();
...
OSStart();
```

5.10.1.2 Task Creation

In a μ C/OS-II application, stacks are declared as static arrays, and the address of either the top or bottom (depending on the CPU) of the stack is passed to `OSTaskCreate`. In a Rabbit-based system, the Dynamic C development environment provides a superior stack allocation mechanism that μ C/OS-II incorporates. Rather than declaring stacks as static arrays, the number of stacks of particular sizes are declared, and when a task is created using either `OSTaskCreate` or `OSTaskCreateExt`, only the size of the stack is passed, not the memory address. This mechanism allows a large number of stacks to be defined without using up root RAM.

There are five macros located in `ucos2.lib` that define the number of stacks needed of five different sizes. To have three 256-byte stacks, one 512-byte stack, two 1024-byte stacks, one 2048-byte stack, and no 4096-byte stacks, the following macro definitions would be used:

```
#define STACK_CNT_256      3    // number of 256 byte stacks
#define STACK_CNT_512      1    // number of 512 byte stacks
#define STACK_CNT_1K       2    // number of 1K stacks
#define STACK_CNT_2K       1    // number of 2K stacks
#define STACK_CNT_4K       0    // number of 4K stacks
```

These macros can be placed into each μ C/OS-II application so that the number of each size stack can be customized based on the needs of the application. Suppose that an application needs 5 tasks, and each task has a consecutively larger stack. The macros and calls to `OSTaskCreate` would look as follows

```
#define STACK_CNT_256      3    // number of 256 byte stacks
#define STACK_CNT_512      1    // number of 512 byte stacks
#define STACK_CNT_1K       2    // number of 1K stacks
#define STACK_CNT_2K       1    // number of 2K stacks
#define STACK_CNT_4K       0    // number of 4K stacks
```

```
OSTaskCreate(task1, NULL, 256, 0);
OSTaskCreate(task2, NULL, 512, 1);
OSTaskCreate(task3, NULL, 1024, 2);
OSTaskCreate(task4, NULL, 2048, 3);
OSTaskCreate(task5, NULL, 4096, 4);
```

Note that `STACK_CNT_256` is set to 2 instead of 1. μ C/OS-II always creates an idle task which runs when no other tasks are in the ready state. Note also that there are two 512 byte stacks instead of one. This is because the program is given a 512 byte stack. If the application utilizes the μ C/OS-II statistics task, then the number of 512 byte stacks would have to be set to 3. (Statistic task creation can be enabled and disabled via the macro `OS_TASK_STAT_EN` which is located in `ucos2.lib`). If only 6 stacks were declared, one of the calls to `OSTaskCreate` would fail.

If an application uses `OSTaskCreateExt`, which enables stack checking and allows an extension of the Task Control Block, fewer parameters are needed in the Rabbit version of μ C/OS-II. Using the macros in the example above, the tasks would be created as follows:

```
OSTaskCreateExt(task1, NULL, 0, 0, 256, NULL, OS_TASK_OPT_STK_CHK |
    OS_TASK_OPT_STK_CLR);

OSTaskCreateExt(task2, NULL, 1, 1, 512, NULL, OS_TASK_OPT_STK_CHK |
    OS_TASK_OPT_STK_CLR);

OSTaskCreateExt(task3, NULL, 2, 2, 1024, NULL, OS_TASK_OPT_STK_CHK |
    OS_TASK_OPT_STK_CLR);

OSTaskCreateExt(task4, NULL, 3, 3, 2048, NULL, OS_TASK_OPT_STK_CHK |
    OS_TASK_OPT_STK_CLR);

OSTaskCreateExt(task5, NULL, 4, 4, 4096, NULL, OS_TASK_OPT_STK_CHK |
    OS_TASK_OPT_STK_CLR);
```

5.10.1.3 Restrictions

At the time of this writing, μ C/OS-II for Dynamic C is not compatible with the use of slice statements. Also, see the function description for `OSTimeTickHook()` for important information about preserving registers if that stub function is replaced by a user-defined function.

Due to Dynamic C's stack allocation scheme, special care should be used when posting messages to either a mailbox or a queue. A message is simply a void pointer, allowing the application to determine its meaning. Since tasks can have their stacks in different segments, auto pointers declared on the stack of the task posting the message should not be used since the pointer may be invalid in another task with a different stack segment.

5.10.2 Tasking Aware Interrupt Service Routines (TA-ISR)

Special care must be taken when writing an interrupt service routine (ISR) that will be used in conjunction with μ C/OS-II so that μ C/OS-II scheduling will be performed at the proper time.

5.10.2.1 Interrupt Priority Levels

μ C/OS-II for the Rabbit reserves interrupt priority levels 2 and 3 for interrupts outside of the kernel. Since the kernel is unaware of interrupts above priority level 1, interrupt service routines for interrupts that occur at interrupt priority levels 2 and 3 should not be written to be tasking aware. Also, a μ C/OS-II application should only disable interrupts by setting the interrupt priority level to 1, and should never raise the interrupt priority level above 1.

5.10.2.2 Possible ISR Scenarios

There are several different scenarios that must be considered when writing an ISR for use with μ C/OS-II. Depending on the use of the ISR, it may or may not have to be written so that it is tasking aware. Consider the scenario in Figure 5.7. In this situation, the ISR for Interrupt X does not have to be tasking aware since it does not re-enable interrupts before completion and it does not post to a semaphore, mailbox, or queue.

Figure 5.7 Type 1 ISR

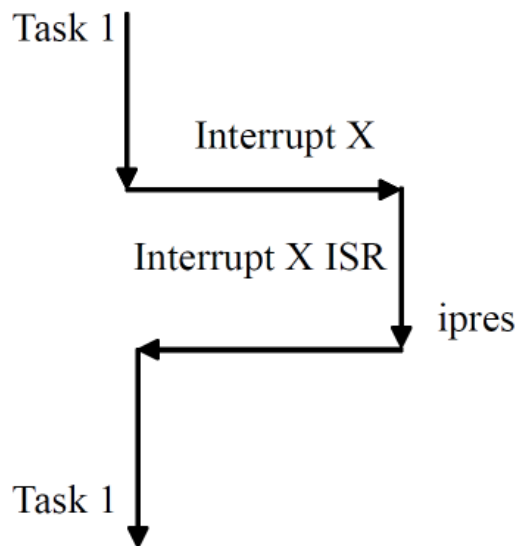

If, however, an ISR needs to signal a task to the ready state, then the ISR must be tasking aware. In the example in Figure 5.8, the TA-ISR increments the interrupt nesting counter, does the work necessary for the ISR, readies a higher priority task, decrements the nesting count, and returns to the higher priority task.

Figure 5.8 Type 2 ISR

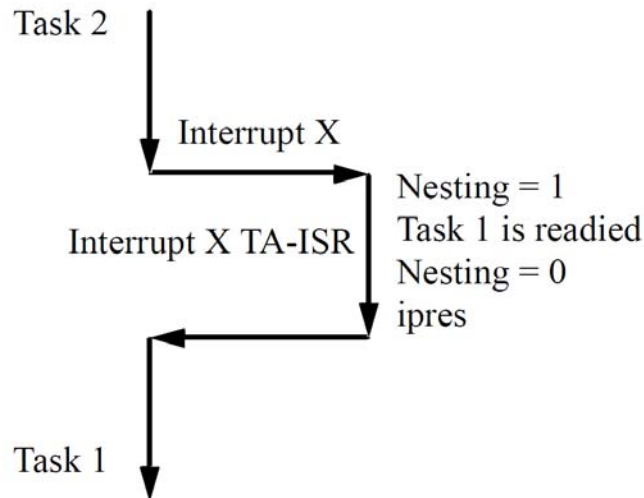

It may seem as though the ISR in Figure 5.8 does not have to increment and decrement the nesting count. However, this is very important. If the ISR for Interrupt X is called during an ISR that re-enables interrupts before completion, scheduling should not be performed when Interrupt X completes; scheduling should instead be deferred until the least nested ISR completes. Figure 5.9 shows an example of this situation.

Figure 5.9 Type 2 ISR Nested Inside Type 3 ISR

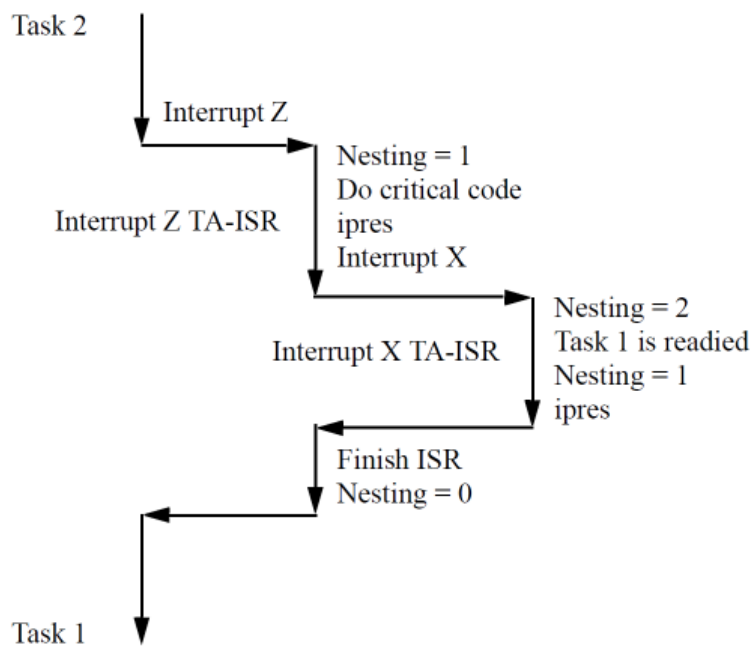

As can be seen here, although the ISR for interrupt Z does not signal any tasks by posting to a semaphore, mailbox, or queue, it must increment and decrement the interrupt nesting count since it re-enables interrupts (`ipres`) prior to finishing all of its work.

5.10.2.3 General Layout of a TA-ISR

A TA-ISR is just like a standard ISR except that it does some extra checking and house-keeping. The following table summarizes when to use a TA-ISR.

Table 5-2. Use of TA-ISR

	μC/OS-II Application		
	Type 1^a	Type 2^b	Type 3^c
TA-ISR Required?	No	Yes	Yes

- a. Type 1—Leaves interrupts disabled and does not signal task to ready state
- b. Type 2—Leaves interrupts disabled and signals task to ready state
- c. Type 3—Reenables interrupts before completion

Figure 5.10 shows the logical flow of a TA-ISR.

Figure 5.10 Logical Flow of a TA-ISR

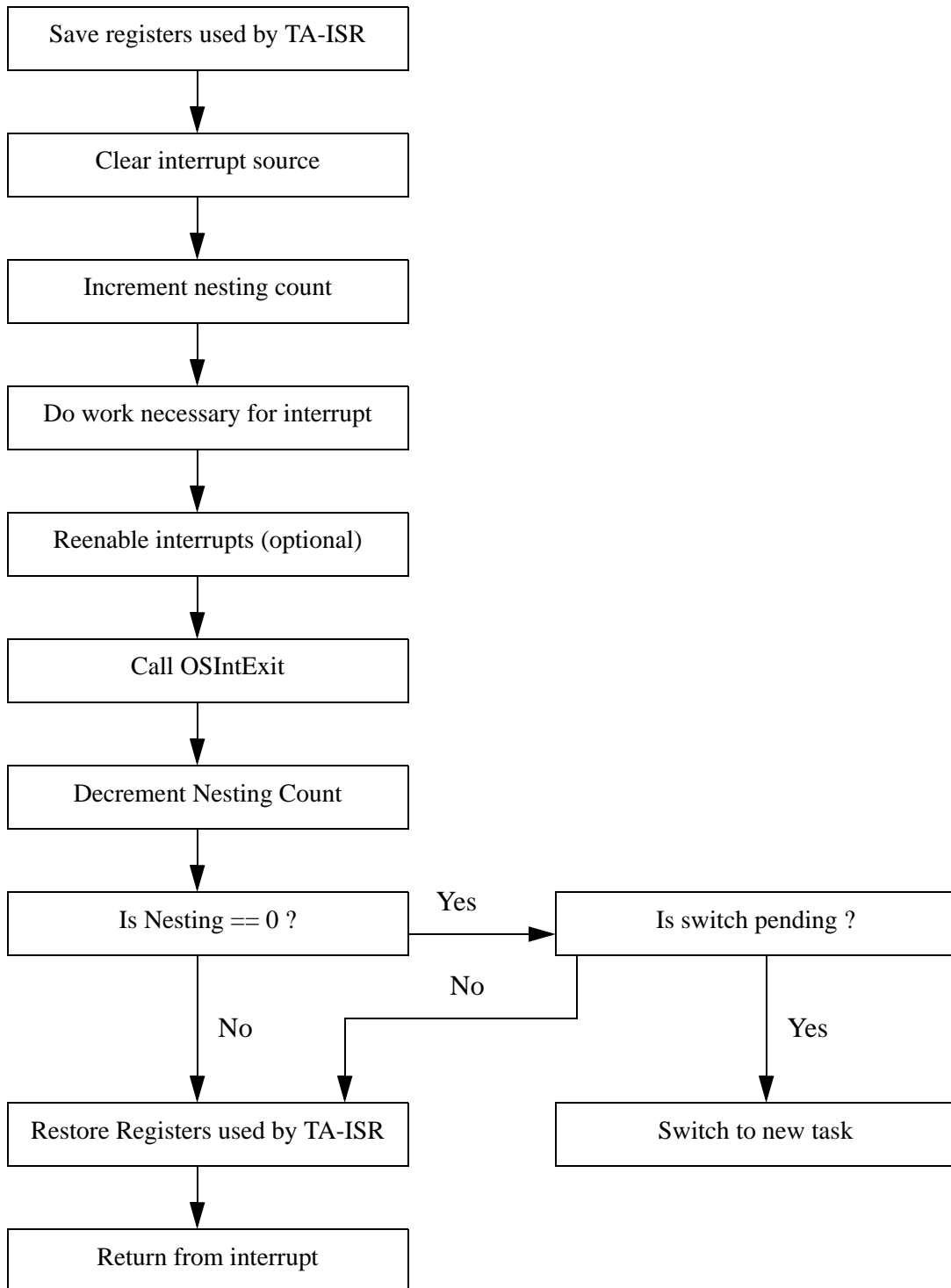

Sample Code for a TA-ISR

Fortunately, the Rabbit BIOS and libraries provide all of the necessary flags to make TA-ISRs work. With the code found in [Listing 1](#), minimal work is needed to make a TA-ISR function correctly with μ C/OS-II. TA-ISRs allow μ C/OS-II the ability to have ISRs that communicate with tasks as well as the ability to let ISRs nest, thereby reducing interrupt latency.

Just like a standard ISR, the first thing a TA-ISR does is to save the registers that it is going to use (1). Once the registers are saved, the interrupt source is cleared (2) and the nesting counter is incremented (3). Note that `bios_intnesting` is a global interrupt nesting counter provided in the Dynamic C libraries specifically for tracking the interrupt nesting level. If an `ipres` instruction is executed (4) other interrupts can occur before this ISR is completed, making it necessary for this ISR to be a TA-ISR.

If it is possible for the ISR to execute before μ C/OS-II has been fully initialized and started multi-tasking, a check should be made (5) to insure that μ C/OS-II is in a known state, especially if the TA-ISR signals a task to the ready state (6).

After the TA-ISR has done its necessary work (which may include making a higher priority task than is currently running ready to run), `OSIntExit` must be called (7). This μ C/OS-II function determines the highest priority task ready to run, sets it as the currently running task, and sets the global flag `bios_swpnd` if a context switch needs to take place. Interrupts are disabled since a context switch is treated as a critical section (8).

If the TA-ISR decrements the nesting counter and the count does not go to zero, then the nesting level is saved in `bios_intnesting` (9), the registers used by the TA-ISR are restored, interrupts are re-enabled (if not already done in (4)), and the TA-ISR returns (12). However, if decrementing the nesting counter in (9) causes the counter to become zero, then `bios_swpnd` must be checked to see if a context switch needs to occur (10).

If a context switch is not pending, then the nesting level is set (9) and the TA-ISR exits (12). If a context switch is pending, then the remaining context of the previous task is saved and a long call, which insures that the `xpc` is saved and restored properly, is made to `bios_intexit` (11). `bios_intexit` is responsible for switching to the stack of the task that is now ready to run and executing a long call to switch to the new task. The remainder of (11) is executed when a previously preempted task is allowed to run again.

Listing 1

```
#asm
taskaware_isr::
    push af                ; push regs needed by isr          ( 1)
    push hl                ; clear interrupt source           ( 2)
    ld hl,bios_intnesting  ; increase the nesting count      ( 3)
    inc (hl)
    ; ipres (optional)                                         ( 4)
    ; do processing necessary for interrupt
    ld a,(OSRunning)      ; MCOS multitasking yet?        ( 5)
    or a
    jr z,taisr_decnesting

    ; possibly signal task to become ready                    ( 6)
    call OSIntExit        ; sets bios_swpnd if higher
                          ; prio ready                            ( 7)

taisr_decnesting:
```

```

push    ip                                (8)
ipset   1

ld      hl,bios_intnesting                ; nesting counter == 1?
dec     (hl)                              (9)
jr      nz,taISR_noswitch

ld      a,(bios_swpend)                   ; switch pending?
or      a
jr      z,taISR_noswitch                  (10)

push    de                                (11)
push    bc
ex      af,af'
push    af
exx
push    hl
push    de
push    bc
push    iy

lcall   bios_intexit

pop     iy
pop     bc
pop     de
pop     hl
exx
pop     af
ex      af,af'
pop     bc
pop     de

taISR_noswitch:
pop     ip

taISR_done:
pop     hl                                (12)
pop     af
ipres
ret
#endasm

```

5.10.3 Library Reentrancy

When writing a μ C/OS-II application, it is important to know which Dynamic C library functions are non-reentrant. If a function is non-reentrant, then only one task may access the function at a time, and access to the function should be controlled with a μ C/OS-II semaphore. The following is a list of Dynamic C functions that are non-reentrant.

Table 5-3. Dynamic C Non-Reentrant Functions

Library	Non-Reentrant Functions
MATH.LIB	randg, randb, rand
RS232.LIB	All
RTCLOCK.LIB	write_rtc, tm_wr
STDIO.LIB	kbhit, getchar, gets, getswf, selectkey
STRING.LIB	atof ^a , atoi, strtok
SYS.LIB	clockDoublerOn, clockDoublerOff, useMainOsc, useClockDivider, use32kHzOsc
VDRIVER.LIB	VdGetFreeWd, VdReleaseWd
XMEM.LIB	WriteFlash
JRIO.LIB	digOut, digOn, digOff, jrioInit, anaIn, anaOut, cof_anaIn
JR485.LIB	All

a. reentrant but sets the global `_xtoxErr` flag

The Dynamic C serial port functions (RS232.LIB functions) should be used in a restricted manner with μ C/OS-II. Two tasks can use the same port as long as both are not reading, or both are not writing; i.e., one task can read from serial port X and another task can write to serial port X at the same time without conflict.

5.10.4 How to Get a μ C/OS-II Application Running

μ C/OS-II is a highly configurable, real-time operating system. It can be customized using as many or as few of the operating system's features as needed. This section outlines:

- The configuration constants used in μ C/OS-II
- How to override the default configuration supplied in UCOS2.LIB
- The necessary steps to get an application running

It is assumed that the reader has a familiarity with μ C/OS-II or has a μ C/OS-II reference (*MicroC/OS-II, The Real-Time Kernel* by Jean J. Labrosse is highly recommended).

5.10.4.1 Default Configuration

μ C/OS-II usually relies on the include file `os_cfg.h` to get values for the configuration constants. In the Dynamic C implementation of μ C/OS-II, these constants, along with their default values, are in `os_cfg.lib`. A default stack configuration is also supplied in `os_cfg.lib`. μ C/OS-II for the Rabbit uses a more intelligent stack allocation scheme than other μ C/OS-II implementations to take better advantage of unused memory.

The default configuration allows up to 10 normally created application tasks running at 64 ticks per second. Each task has a 512-byte stack. There are 2 queues specified, and 10 events. An event is a queue, mailbox or semaphore. You can define any combination of these three for a total of 10. If you want more than 2 queues, however, you must change the default value of `OS_MAX_QS`.

Some of the default configuration constants are:

<code>OS_MAX_EVENTS</code>	Max number of events (semaphores, queues, mailboxes) Default is 10
<code>OS_MAX_TASKS</code>	Maximum number of tasks (less stat and idle tasks) Default is 10
<code>OS_MAX_QS</code>	Max number of queues in system Default is 2
<code>OS_MAX_MEM_PART</code>	Max number of memory partitions Default is 1
<code>OS_TASK_CREATE_EN</code>	Enable normal task creation Default is 1
<code>OS_TASK_CREATE_EXT_EN</code>	Disable extended task creation Default is 0
<code>OS_TASK_DEL_EN</code>	Disable task deletion Default is 0
<code>OS_TASK_STAT_EN</code>	Disable statistics task creation Default is 0
<code>OS_Q_EN</code>	Enable queue usage Default is 1
<code>OS_MEM_EN</code>	Disable memory manager Default is 0
<code>OS_MBOX_EN</code>	Enable mailboxes Default is 1
<code>OS_SEM_EN</code>	Enable semaphores Default is 1
<code>OS_TICKS_PER_SEC</code>	Number of ticks in one second Default is 64
<code>STACK_CNT_256</code>	Number of 256 byte stacks (idle task stack) Default is 1

STACK_CNT_512	Number of 512-byte stacks (task stacks + initial program stack) Default is OS_MAX_TASKS+1 (11)
----------------------	--

If a particular portion of μ C/OS-II is disabled, the code for that portion will not be compiled, making the overall size of the operating system smaller. Take advantage of this feature by customizing μ C/OS-II based on the needs of each application.

5.10.4.2 Custom Configuration

In order to customize μ C/OS-II by enabling and disabling components of the operating system, simply redefine the configuration constants as necessary for the application.

```
#define OS_MAX_EVENTS      2
#define OS_MAX_TASKS      20
#define OS_MAX_QS         1
#define OS_MAX_MEM_PART   15
#define OS_TASK_STAT_EN   1
#define OS_Q_EN           0
#define OS_MEM_EN         1
#define OS_MBOX_EN        0
#define OS_TICKS_PER_SEC  64
```

If a custom stack configuration is needed also, define the necessary macros for the counts of the different stack sizes needed by the application.

```
#define STACK_CNT_256 1 // idle task stack
#define STACK_CNT_512 2 // initial program + stat task stack
#define STACK_CNT_1K 10 // task stacks
#define STACK_CNT_2K 10 // number of 2K stacks
```

In the application code, follow the μ C/OS-II and stack configuration constants with a `#use "ucos2.lib"` statement. This ensures that the definitions supplied outside of the library are used, rather than the defaults in the library.

This configuration uses 20 tasks, two semaphores, up to 15 memory partitions that the memory manager will control, and makes use of the statistics task. Note that the configuration constants for task creation, task deletion, and semaphores are not defined, as the library defaults will suffice. Also note that ten of the application tasks will each have a 1024 byte stack, ten will each have a 2048 byte stack, and an extra stack is declared for the statistics task.

5.10.4.3 Examples

The following sample programs demonstrate the use of the default configuration supplied in `UCOS2.LIB` and a custom configuration which overrides the defaults.

Example 1

In this application, ten tasks are created and one semaphore is created. Each task pends on the semaphore, gets a random number, posts to the semaphore, displays its random number, and finally delays itself for three seconds.

Looking at the code for this short application, there are several things to note. First, since μ C/OS-II and slice statements are mutually exclusive (both rely on the periodic interrupt for a "heartbeat"), `#use`

"ucos2.lib" must be included in every μ C/OS-II application (1). In order for each of the tasks to have access to the random number generator semaphore, it is declared as a global variable (2). In most cases, all mailboxes, queues, and semaphores will be declared with global scope. Next, `OSInit()` must be called before any other μ C/OS-II function to ensure that the operating system is properly initialized (3). Before μ C/OS-II can begin running, at least one application task must be created. In this application, all tasks are created before the operating system begins running (4). It is perfectly acceptable for tasks to create other tasks. Next, the semaphore each task uses is created (5). Once all of the initialization is done, `OSStart()` is called to start μ C/OS-II running (6). In the code that each of the tasks run, it is important to note the variable declarations. Each task runs as an infinite loop and once this application is started, μ C/OS-II will run indefinitely.

```
// 1. Explicitly use  $\mu$ C/OS-II library
#include "ucos2.lib"

void RandomNumberTask(void *pdata);

// 2. Declare semaphore global so all tasks have access
OS_EVENT* RandomSem;

void main(){
    int i;

    // 3. Initialize OS internals
    OSInit();

    for(i = 0; i < OS_MAX_TASKS; i++)
        // 4. Create each of the system tasks
        OSTaskCreate(RandomNumberTask, NULL, 512, i);

    // 5. semaphore to control access to random number generator
    RandomSem = OSSemCreate(1);

    // 6. Begin multitasking
    OSStart();
}

void RandomNumberTask(void *pdata)
{
    OS_TCB data;
    INT8U err;
    INT16U RNum;

    OSTaskQuery(OS_PRIO_SELF, &data);
    while(1)
    {
        // Rand is not reentrant, so access must be controlled via a semaphore.
        OSSemPend(RandomSem, 0, &err);
        RNum = (int)(rand() * 100);
        OSSemPost(RandomSem);
        printf("Task%d's random #: %d\n",data.OSTCBPrio,RNum);

        // Wait 3 seconds in order to view output from each task.
        OSTimeDlySec(3);
    }
}
```

Example 2

This application runs exactly the same code as Example 1, except that each of the tasks are created with 1024-byte stacks. The main difference between the two is the configuration of μ C/OS-II.

First, each configuration constant that differs from the library default is defined. The configuration in this example differs from the default in that it allows only two events (the minimum needed when using only one semaphore), 20 tasks, no queues, no mailboxes, and the system tick rate is set to 32 ticks per second (1). Next, since this application uses tasks with 1024 byte stacks, it is necessary to define the configuration constants differently than the library default (2). Notice that one 512 byte stack is declared. Every Dynamic C program starts with an initial stack, and defining `STACK_CNT_512` is crucial to ensure that the application has a stack to use during initialization and before multi-tasking begins. Finally `ucos2.lib` is explicitly used (3). This ensures that the definitions in (1 and 2) are used rather than the library defaults. The last step in initialization is to set the number of ticks per second via `OSSetTicksPerSec` (4). The rest is identical to example 1 and is explained in the previous section.

```
// 1. Define necessary configuration constants for uC/OS-II
#define OS_MAX_EVENTS          2
#define OS_MAX_TASKS          20
#define OS_MAX_QS              0
#define OS_Q_EN                0
#define OS_MBOX_EN            0
#define OS_TICKS_PER_SEC      32

// 2. Define necessary stack configuration constants
#define STACK_CNT_512 1          // initial program stack
#define STACK_CNT_1K OS_MAX_TASKS // task stacks

// 3. This ensures that the above definitions are used
#include "ucos2.lib"

void RandomNumberTask(void *pdata);

// Declare semaphore global so all tasks have access
OS_EVENT* RandomSem;

void main(){
    int i;

    // Initialize OS internals
    OSInit();

    for(i = 0; i < OS_MAX_TASKS; i++){
        // Create each of the system tasks
        OSTaskCreate(RandomNumberTask, NULL, 1024, i);
    }
    // semaphore to control access to random number generator
    RandomSem = OSSemCreate(1);

    // 4. Set number of system ticks per second
    OSSetTicksPerSec(OS_TICKS_PER_SEC);

    // Begin multi-tasking
    OSStart();
}
```

```

void RandomNumberTask(void *pdata)
{
    // Declare as auto to ensure reentrancy.
    auto OS_TCB data;
    auto INT8U err;
    auto INT16U RNum;

    OSTaskQuery(OS_PRIO_SELF, &data);
    while(1)
    {
        // Rand is not reentrant, so access must be controlled via a semaphore.
        OSSemPend(RandomSem, 0, &err);
        RNum = (int)(rand() * 100);
        OSSemPost(RandomSem);

        printf("Task%02d's random #: %d\n", data.OSTCBPrio, RNum);

        // Wait 3 seconds in order to view output from each task.
        OSTimeDlySec(3);
    }
}

```

5.10.5 Compatibility with TCP/IP

The TCP/IP stack is reentrant and may be used with the μ C/OS-II real-time kernel. The line

```
#use ucos2.lib
```

must appear before the line

```
#use dcrtcp.lib
```

A call to `OSInit()` must be made before calling `sock_init()`.

5.10.5.1 Stack Size

The TCP/IP stack requires a μ C/OS-II task to have a minimum stack size of 2K. Recall that the number of 2K stacks is defined by `STACK_CNT_2K`. If there are problems with sending a packet, try increasing the stack size to 4K.

5.10.5.2 Socket Locks

Each socket used in a μ C/OS-II application program has an associated socket lock. Each socket lock uses one semaphore of type `OS_EVENT`. Therefore, the macro `MAX_OS_EVENTS` must take into account each of the socket locks, plus any events that the application program may be using (semaphores, queues, mailboxes, event flags, or mutexes).

Determining `OS_MAX_EVENTS` may get a little tricky, but it isn't too bad if you know what your program is doing. Since `MAX_SOCKET_LOCKS` is defined as:

```
#define MAX_SOCKET_LOCKS (MAX_TCP_SOCKET_BUFFERS +
    MAX_UDP_SOCKET_BUFFERS)
```

`OS_MAX_EVENTS` may be defined as:

```
#define OS_MAX_EVENTS MAX_TCP_SOCKET_BUFFERS +
    MAX_UDP_SOCKET_BUFFERS + 2 + z
```

The constant “2” is included for the two global locks used by TCP/IP, and “z” is the number of `OS_EVENTS` (semaphores, queues, mailboxes, event flags, or mutexes) required by the program.

If either `MAX_TCP_SOCKET_BUFFERS` or `MAX_UDP_SOCKET_BUFFERS` is not defined by the application program prior to the `#use` statements for `ucos.lib` and `dcrtcp.lib`, default values will be assigned.

If `MAX_TCP_SOCKET_BUFFERS` is not defined in the application program, it will be defined as `MAX_SOCKETS`. If, however, `MAX_SOCKETS` is not defined in the application program, `MAX_TCP_SOCKET_BUFFERS` will be 4.

If `MAX_UDP_SOCKET_BUFFERS` is not defined in the application program, it will be defined as 1 if `USE_DHCP` is defined, or 0 otherwise.

For more information about TCP/IP, please see the *Dynamic C TCP/IP User's Manual, Volumes 1 and 2*, available online at www.rabbit.com.

5.10.6 Debugging Tips

Single stepping may be limited to the currently running task by using the F8 key (Step over). If the task is suspended, single stepping will also be suspended. When the task is put back in a running state, single stepping will continue at the statement following the statement that suspended execution of the task.

Pressing the F7 key (Trace into) at a statement that suspends execution of the current task will cause the program to step into the next active task that has debug information. It may be useful to put a watch on the global variable `OSPrIoCur` to see which task is currently running.

For example, if the current task is going to call `OSSemPend ()` on a semaphore that is not in the signaled state, the task will be suspended and other tasks will run. If F8 is pressed at the statement that calls `OSSemPend ()`, the debugger will not single step in the other running tasks that have debug information; single stepping will continue at the statement following the call to `OSSemPend ()`. If F7 is pressed at the statement that calls `OSSemPend ()` instead of F8, the debugger will single step in the next task with debug information that is put into the running state.

5.11 Summary

Although multitasking may actually decrease processor throughput slightly, it is an important concept. A controller is often connected to more than one external device. A multitasking approach makes it possible to write a program controlling multiple devices without having to think about all the devices at the same time. In other words, multitasking is an easier way to think about the system.

6. DEBUGGING WITH DYNAMIC C

This chapter is intended for anyone debugging Dynamic C programs. For the person with little to no experience, we offer general debugging strategies in [Section 6.4](#). Both experienced and inexperienced Dynamic C users can refer to [Section 6.2](#) to see the full set of tools, programs and functions available for debugging Dynamic C programs. [Section 6.3](#) consolidates the information found in the GUI chapter regarding debugging features into a quicker-to-read table of GUI options. And lastly, [Section 6.5](#) gives some good references for further study.

Dynamic C comes with robust capabilities to make debugging faster and easier. The debugger is highly configurable; it is easy to enable or disable the debugger features using the [Project Options](#) dialog.

6.1 Debugging Features of Dynamic C

The following Dynamic C debugging features are summarized here, with links given to more detailed descriptions.

- [printf\(\)](#) - Display messages to the Stdio window (default) or redirect to a serial port. May also write to a file.
- [Software Breakpoints](#) - Stop execution, allow the available debug windows to be examined: Stack, Assembly, Dump and Register windows are always available.
- [Hardware Breakpoints](#) - The Run menu item “Add/Edit Hardware Breakpoints” lets you set up to six hardware breakpoints on instruction fetches, data reads, and data writes. Note that a hardware breakpoint is not the same as a [hard breakpoint](#). (Support for hardware breakpoints was added in Dynamic C 10.21.)
- [Single Stepping](#) - Execute one C statement or one assembly statement. This is an extension of breakpoints, so again, the Stack, Assembly, Dump and Register windows are always available.
- [Watch Expressions](#) - Keep running track of any valid C expression in the application. Fly-over hints evaluate any watchable statement.
- [Memory Dump](#) - Displays blocks of raw values and their ASCII representation at any memory location (can also be sent to a file).
- [MAP File](#) - Shows a global view of the program: memory usage, mapping of functions, global/static data, parameters and local auto variables, macro listing and a function call graph.
- [Assert Macro](#) - This is a preventative measure, a kind of defensive programming that can be used to check assumptions before they are used in the code.
- [Blinking Lights](#) - LEDs can be toggled to indicate a variety of conditions. This requires a signal line connected to an LED on the board.

- **Symbolic Stack Trace** - Helps customers find out the path of the program at each single step or break point. By looking through the stack, it is possible to reconstruct the path and allow the customer to easily move backwards in the current call tree to get a better feeling for the current debugging context.
- **Persistent Breakpoints** - Persistent breakpoints mean the information is retained when transitioning back and forth from edit mode to debug mode and when a file is closed and re-opened.
- **Enhanced Watch Expressions** - The Watches window is now a tree structure capable of showing struct members. That is, all members of a structure become viewable as watch expressions when a structure is added, without having to add them each separately.
- **Enhanced Memory Dumps** - Changed data in the Memory Dump window is highlighted in reverse video or in customizable colors every time you single step in either C or assembly.
- **Enhanced Mode Switching** - Debug mode can be entered without a recompile and download. If the contents of the debugged program are edited, Dynamic C prompts for a recompile.
- **Enhanced Stdio Window** - The Stdio window is directly searchable.

6.2 Debugging Tools

This section describes the different tools available for debugging, including their pros and cons, as well as when you might want to use them, how to use them and an example of using them. The examples are suggestions and are not meant to be restrictive. While there may be some collaboration, bug hunting is largely a solitary sport, with different people using different tools and methods to solve the same problem.

6.2.1 printf()

The `printf()` function has always been available in Dynamic C, with output going to the Stdio window by default, and optionally to a file (by configuring the Stdio window contents to log to a file). There is also the ability to redirect output to any one of the available serial ports A, B, C, D, E or F. See `Samples\stdio_serial.c` for instructions on how to use the serial port redirect. This feature is intended for debug purposes only.

The syntax for `printf()` is explained in detail in the *Dynamic C Function Reference Manual*, including a listing of allowable conversion characters.

Pros A `printf()` statement is quick, easy and sometimes all that is needed to nail down a problem.

You can use `#ifdef` directives to create levels of debugging information that can be conditionally compiled using macro definitions. This is a technique used by Rabbit engineers when developing Dynamic C libraries. In the library code you will see statements such as:

```
#ifdef LIBNAME_DEBUG
    printf("Insert information here.\n");
    ...
#endif
...
#ifdef LIBNAME_VERBOSE
    printf("Insert more information.\n");
    ...
#endif
```

By defining the above mentioned macro(s) you include the corresponding `printf` statements.

Cons The `printf()` function is so easy to use, it is easy to overuse. This can lead to a shortage of root memory. A solution to this that allows you to still have lots of `printf` strings is to place the strings in extended memory (xmem) using the keyword `xdata` and then call `printf()` with the conversion character “%ls.” An overuse of `printf` statements can also affect execution time.

Uses Use to check a program’s flow without stopping its execution.

Example There are numerous examples of using `printf()` in the programs provided in the Samples folder where you installed Dynamic C.

To display a string to the Stdio window place the following line of code in your application:

```
printf("Entering my_function().\n");
```

To do the same thing, but without using root memory:

```
xdata entering {"Entering my_function()."};
...
printf("%ls\n", entering);
```

6.2.2 ANSI Escape Sequences

Dynamic C's STDIO window supports the following small subset of the so-called "ANSI Escape Sequences" as described originally in the ANSI X3.64 standard (withdrawn), ISO/IEC 6429 and ECMA-48 (fourth edition):

ESC [n A	Cursor up n lines.
ESC [n B	Cursor down n lines.
ESC [n C	Cursor forward n columns.
ESC [n D	Cursor backward n columns.
ESC [y ; x H	Move cursor to row y, column x. Values start at 1.
ESC [2 J	Clear the entire screen & move to home position (n=2).
ESC [K	Clear to end of line.
ESC [n m	Reset attributes (n=0) or set attribute n.
0 = reset	Colors: 0 = black
7 = reverse (white on black)	1 = red
8 = concealed (white on white)	2 = green
30 + Color = foreground color	3 = yellow
40 + Color = background color	4 = blue
	5 = magenta
	6 = cyan
	7 = white
	9 = reset

Note: A semicolon-separated attributes list is supported (e.g. `ESC [n1 ; n2 ; ... m`).

ESC [s Save cursor position.

ESC [u Restore cursor position.

For a colorful example of using ANSI escape sequences in Dynamic C's STDIO window, please run the `Samples\enum.c` standard sample program.

6.2.3 Software Breakpoints

Software breakpoints are versatile. There is the ability to set breakpoints in ISRs, the existence of persistent breakpoints and the ability to set breakpoints in edit mode. There is also a “Clear All Breakpoints” command. Dynamic C 10.21 changes the keyboard shortcut for clearing all software breakpoints from Ctrl+A to Ctrl+B.

Pros Software breakpoints can be set on any C statement unless it is marked “nodebug” and in any “#asm debug” assembly block. This includes code in library files. Breakpoints let you run a program at full speed until the specified stopping point is reached. You can set multiple breakpoints in a program or even on the same line. They are easy to toggle on and off individually and can all be cleared with one command. You can choose whether to leave interrupts turned on (soft breakpoint) or not (hard breakpoint).

When stopped at a breakpoint, you can examine up-to-date contents in debug windows and choose other debugging features to employ, such as single stepping, dumping memory, fly-over watch expressions.

Cons To support large sector flash, breakpoint internals require that breakpoint overhead remain, even when the breakpoint has been toggled off. Recompile the program to remove this overhead.

When the debug keyword is added to an assembly block, relative jumps (which are limited to 128 bytes) may go out of range. If this happens, change the JR instruction to a JP instruction. Another solution is to embed a null C statement in the assembly code like so:

```
#asm
...
c ; // Set a breakpoint on the semicolon
...
#endasm
```

Uses Use software breakpoints when you need to stop at a specified location to begin single stepping or to examine variables, memory locations or register values.

Example Open `Samples\Demo1.c`. Press F5 to compile the program, then place the cursor on the word “for” and press F2 to insert a breakpoint. Now press F9. Every time you press F9 program execution will stop when it hits the start of the for loop. From here you can single step or look at a variety of information through debug windows. For example, say there is a problem when you get to the limit of a for loop. You can use the “Evaluate Expressions” dialog to set the looping variable to a value that brings program execution to the exact spot that you want, as shown in this screenshot:

Figure 6.1 Altering the Looping Variable when Stopped at a Breakpoint

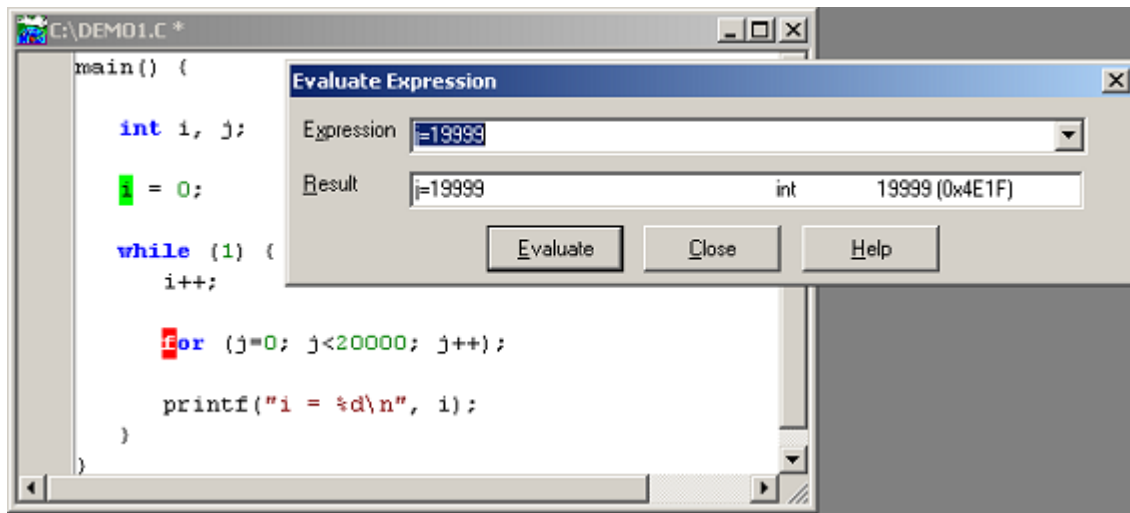

6.2.4 Hardware Breakpoints

The Rabbit processor has seven hardware breakpoints. Dynamic C 10.21 introduced support for this processor feature. One of the seven hardware breakpoints is used by the debug kernel. The remaining six hardware breakpoints may be configured by selecting the “Add | Edit Hardware Breakpoints” item from the Run menu.

Pros Hardware breakpoints can be set on any instruction fetch or any data read or write, this includes code marked as “nodebug”. You can set multiple breakpoints in a program.

When stopped at a breakpoint, you can examine up-to-date contents in debug windows and choose other debugging features to employ, such as single stepping, dumping memory, and fly-over watch expressions.

Cons Hardware breakpoints are more time-consuming to configure than software breakpoints. You must know the address where you wish to stop and also whether the access is for data or code.

Uses Allows greater access to “nodebug” Dynamic C library code during program execution. Offers increased knowledge when tracking hard to debug memory corruption errors.

The “Mask” text box in the “Add/Edit Hardware breakpoints” dialog lets you specify “don’t care” digits in the address, thus using a single breakpoint address to set a range of addresses that will trigger the breakpoint.

Example The debug windows make configuring a hardware breakpoint straightforward. For instance, the Assembly window lists an address for each instruction, so breaking on an instruction fetch is just a matter of finding the instruction in the Assembly window and typing its address into the hardware breakpoint dialog box, as shown in the screen shot below of Demo1.c.

Table 6-1. Samples\Demo1.c

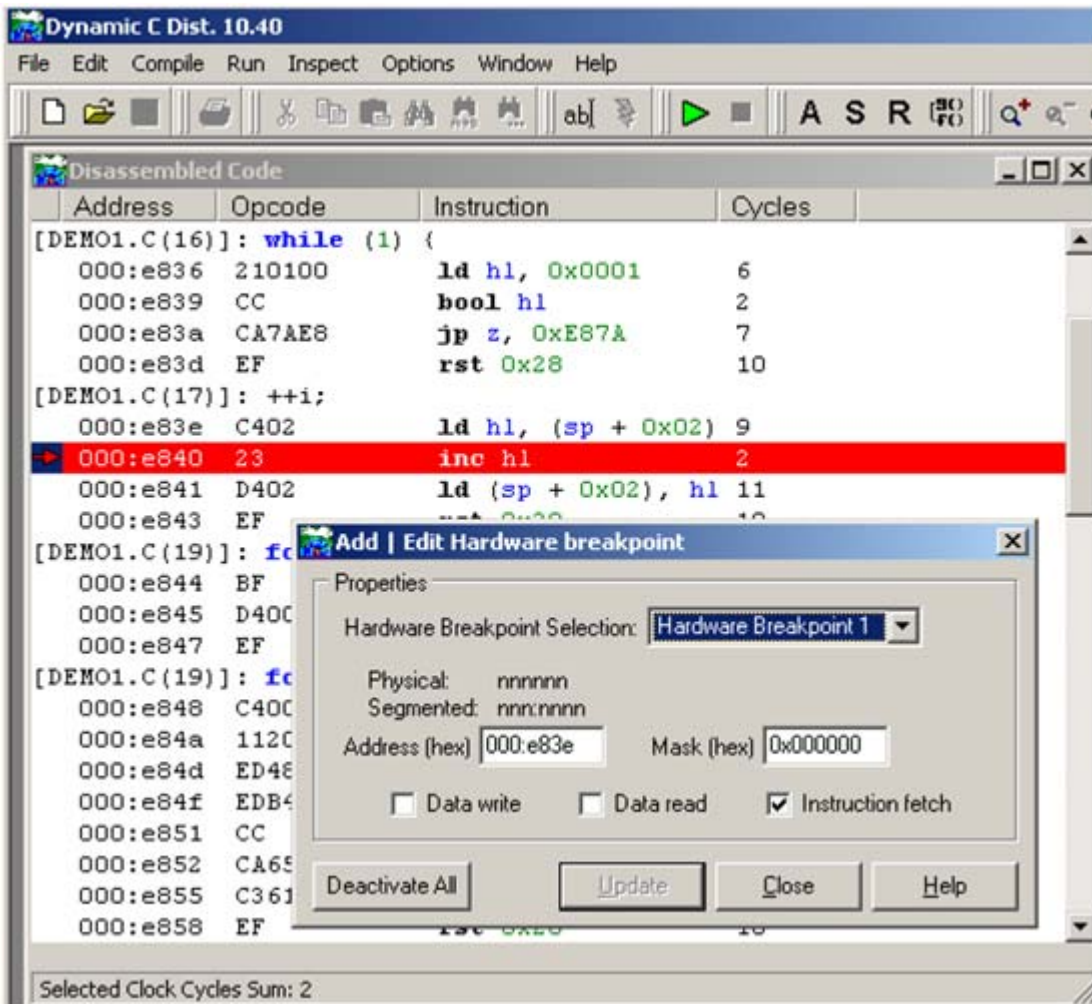

Hardware breakpoints cause the processor to stop at the address logically after the break address specified, thus “Hardware Breakpoint 1” is set for 000:e83e, but program execution stopped at 000:e840. The PC was incremented twice for the 2-byte opcode of the “ld” instruction. For an instruction fetch breakpoint, the processor will stop after executing the instruction at the breakpoint address.

In addition to debug windows, the [MAP File](#) can be used to find out addresses for code and data. The map file is a rich source of memory mapping information, listing everything from local variables to the origin and size of code and data segments.

Setting a hardware breakpoint on some internal I/O addresses can lead to a target communication error. Since setting a breakpoint mask to 0xfffff will include all internal I/O address, the address and mask should be set to include only the intended range of addresses.

Starting with Dynamic C 10.54, hardware breakpoints are disabled when code is executing within the debug kernel.

6.2.5 Single Stepping

Single stepping can be a very useful debugging technique.

Pros Single stepping allows you to closely supervise program execution at the source code level, either by C statement or assembly statement. This helps in tracing the logic of the program. You can single step any debuggable statement. Even Dynamic C library functions can be stepped into as long as they are not flagged as `nodebug`.

Cons Single stepping is of limited use if interaction with an external device is being examined; an external device does not stop whatever it is doing just because the execution of the application has been restrained.

Also, single stepping can be very tedious if stepping through many instructions. Well-placed breakpoints might serve you better.

Uses Single stepping is typically used when you have isolated the problem and have stopped at the area of interest using a breakpoint.

Example

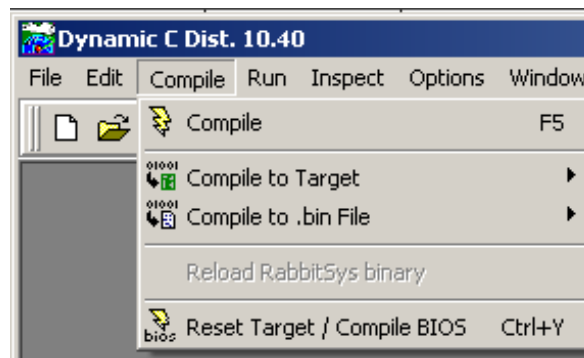

To single step through a program instead of running at full execution speed, compile the program without running it.

To compile the program without running it, use the Compile menu option, the keyboard shortcut F5 or the toolbar menu button (pictured to the left of the Compile menu option).

F7, F8, Alt+F7 and Alt+F8 are the keyboard shortcuts for stepping through code. Use F7 if you want to step at the C statement level, but want to step into calls to debuggable functions. Use F8 instead if you want to step over function calls.

If the Assembly window is open, the stepping will be done by assembly instruction instead of by C statement if the feature “Enable instruction level single stepping” is checked on the Debugger tab of the Project Options dialog; otherwise, stepping is done by C statement regardless of the status of the Assembly window. If you have checked “Enable instruction level single stepping” but wish to continue to step by C statement when the Assembly window is open, use Alt+F7 or Alt+F8 instead of F7 or F8.

6.2.6 Watch Expressions

The watch expressions feature applies to any valid C expression. It is possible to evaluate watchable expressions using flyover hints. (The highlighted expression does not need to be set as a watch expression for evaluation in a flyover hint.) When a structure is set as a watch expression, all of its members are set automatically as watch expressions.

- Pros** Any valid C expression can be watched. Multiple expressions can be watched simultaneously. Once a watch is set on an expression, its value is updated in the Watches window whenever program execution is stopped.
- The Watches window may be updated while the program is running (which will affect timing) by issuing the “Update Watch Window” command: use the Inspect menu, Ctrl+U or the toolbar menu button shown here to update the Watches window.
- You can use flyover hints to find out the value of any highlighted C expression when the program is stopped.
- Cons** The scope of variables in watch expressions affects the value that is displayed in the Watches window. If the variable goes out of scope, its true value will not be displayed until it comes back into scope.
- Keep in mind two additional things, which are not bad per se, but could be if they are used carelessly: Assignment statements in a watch expression will change the value of a variable every time watches are evaluated. Similarly, when a function call is in a watch expression, the function will run every time watches are evaluated.
- Uses** Use a watch expression when the value of the expression is important to the behavior of the part of the program you are analyzing.
- Example** Watch expressions can be used to evaluate complicated conditionals. A quick way to see this is to run the program `Samples\pong.c`. Set a breakpoint at this line
- ```
if (nx <= x1 || nx >= xh)
```
- within the function `pong()`. While the program is stopped, highlight the section of the expression you want evaluated. Use the watches flyover hint by hovering the cursor over the highlighted expression. It will be evaluated and the result displayed. You can see the values of, e.g., `nx` or `x1` or the result of the conditional expression `nx <= x1`, depending on what you highlight.
- Keep in mind that when single stepping in assembly, the value of the watch expression may not be valid for variables located on the stack (all auto variables). This is because the debug kernel does not keep track of the pushes and pops that occur on the stack, and since watches of stack variables only make sense in the context of the pushes and pops that have happened, they will not always be accurate when assembly code is being single stepped.

## 6.2.7 Evaluate Expressions

The evaluate expression functionality is a special case of a watch expression evaluation in that the evaluation takes place once, when the Evaluate button is clicked, not every time the Watches window is updated.

- Pros** Like watches, you can use the Evaluate Expression feature on any valid C expression. Multiple Evaluate Expression dialogs can be opened simultaneously.
- Cons** Can alter program data adversely if the change being made is not thought out properly
- Uses** This feature can be used to quickly and easily explore a variant of program flow.
- Example** Say you have an application that is supposed to treat the 100th iteration of a loop as a special case, but it does not. You do not want to set a breakpoint on the looping statement and hit F9 that many times, so instead you force the loop variable to equal 99 using the evaluate expression dialog. To do this compile the program without running it. Set a breakpoint at the start of the loop and then single step to get past the loop variable initialization. Open the Inspect menu and choose Evaluate Expression. Type in “j=99” and click on the Evaluate button. Now you are ready to start examining the program’s behavior.

## 6.2.8 Memory Dump

The Dump window is a versatile tool. For example, multiple dump windows can be active simultaneously, flyover hints make it easier to see the correct address, and three different types of dumps are allowed. Read the section titled, “[Debugging Tools](#)” for more information on these topics. Another useful feature of the Dump window is that values that have changed are shown highlighted in reverse video or in customizable colors.

- Pros** Dump windows allow access to any memory location, beginning at any address. There are alignment options; the data can be viewed as bytes, words or double-words using a right-click menu.
- Cons** The Dump window does not contain symbolic information, which makes some information harder to decipher. There is the potential for increased debugging overhead if you open multiple dump windows and make them large.
- Uses** Use a dump window when you suspect memory is being corrupted or to watch string or numerical data manipulation proceed. String manipulation can easily cause memory corruption if you are not careful.
- Example** Consider the following code:

```
char my_array[10];
for (i=0; i<=10; i++){
 my_array[i] = 0xff;
}
```

If you do not have run-time checking of array indices enabled, this code will corrupt whatever is immediately following `my_array` in memory.

There is no run-time checking for string manipulation, so if you wrote something like the following in your application, memory would be corrupted when the null terminator for the string “1234” was written.

```
void foo () {
 int x;
 char str[4];
 x = 0xffff;
 strcpy(str, "1234");
}
```

Watching changes in a dump window will make the mistake more obvious in both of these situations, though in the former, turning on run-time checking for array indices in the Compiler tab of the Project Options dialog is easier.

## 6.2.9 MAP File

Map files are always generated for compiled programs.

- Pros**            The map file is full of useful information. It contains:
- location and size of code and data segments
  - a list of all symbols used, their location, size and file of origin
  - a list of all macros used, their file of origin and the line number within that file where the macro is defined
  - function call graph

A valid map file is produced after a successful compile, so it is available when a program crashes.

- Cons**            If the compile was not successful, for example you get a message that says you ran out of root code space, the map file will still be created, but will contain incomplete and possibly incorrect information.

- Uses**            Map files are useful when you want to gather more data or are trying to get a comprehensive overview of the program. A map file can help you make better use of memory in cases where you are running short or are experiencing stack overflow problems.

- Example**        Say you are pushing the limits of memory in your application and want to see where you can shave bytes. The map file contains sizes for all the data used in your program. The screen shot below shows some code and part of its map file. Maybe you meant to type “200” as the size for `my_array` and added a zero on the end by mistake. (This is a good place to mention that using hard-coded values is more prone to error than defining and using constants.)

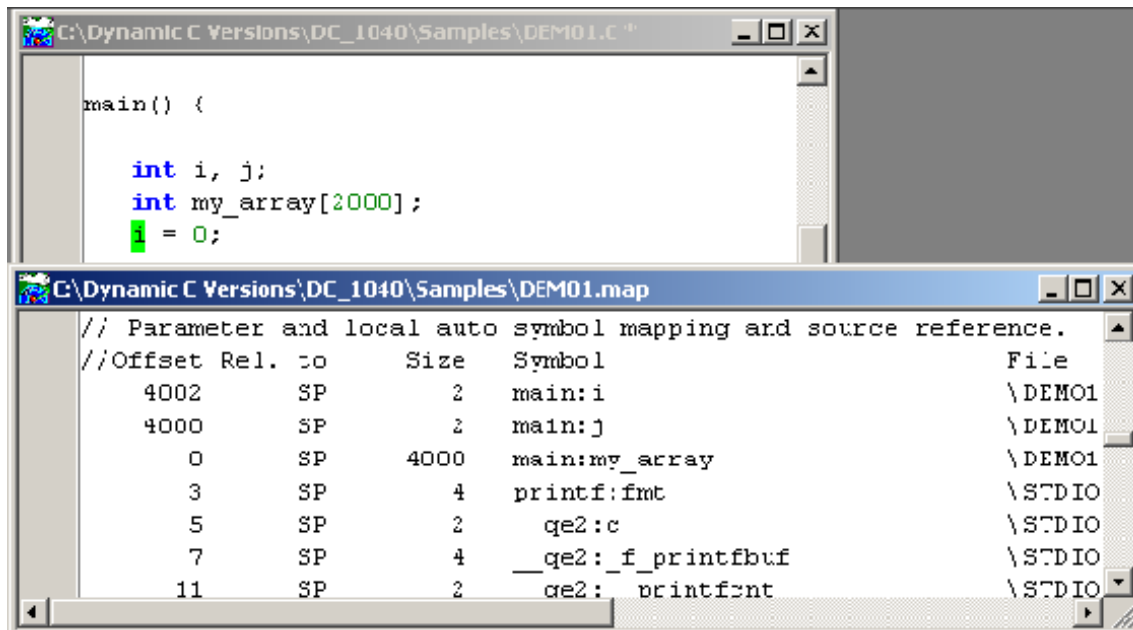

Scanning the size column, the mistake jumps out at you more readily than looking at the code, maybe because you expect to see “200” and so your brain filters out the extra zero. For whatever reason, looking at the same information in a different format allows you to see more.

The size value for functions might not be accurate because it measures code distance. In other words, if a function spans a gap created with a *follows* action, the size reported for the function will be much greater than the actual number of bytes added to the program. The follows action is an advanced topic related to the subject of origin directives. See the *Rabbit 4000 Designer's Handbook* for a discussion of origin directives and action qualifiers.

The map file provides the logical and physical addresses of the program and its data. The screen shot below shows a small section of `demo1.map`. The left-most column shows line numbers, with addresses to their immediate right. Using the addresses we can reproduce the actions taken by the Memory Management Unit (MMU) of the Rabbit. Addresses with four digits are both the logical and the physical address. That is because in the logical address space they are in the base segment, which always starts at zero in the physical address space. You can see this for yourself by opening two dump windows: one with a four-digit logical address and the second with that same four-digit number but with a leading zero, making it a physical address. The contents of the dump windows will be the same.

```

C:\Dynamic C Versions\DC_1040\Samples\DEM01.map
0004:e018 * __dk_execallwatches \DKAPP.LIB
0004:e036 * __dk_getenabledoptions \DKAPP.LIB
0004:e05f * dkGetCharFromStdio \DKCORE.LI

// Global/static data symbol mapping and source reference.
// Addr Size Symbol File
b3c5 1 dkStatusFlags \DKCORE.LIB
b3c4 1 dkSendFlags \DKCORE.LIB
b3c3 1 dkRequest \DKCORE.LIB
b3c2 1 dkAckToSend \DKCORE.LIB
b3c1 1 dkStepFlags \DKCORE.LIB
b3bf 2 dkptrASMBuf \DKCORE.LIB
bff8 8 dkASMBuf \DKCORE.LIB
b380 63 dkRegisters \DKCORE.LIB
b37c 4 dkNextAddress \DKCORE.LIB

```

The addresses in the format xx:yyyy are physical addresses. For code xx is the XPC value, for data it is the value of DATASEG; yyyy is the PC value for both code and data. In the above map file you can see examples of both code and data addresses. Addresses in the format xx:yyyy are transformed by the MMU into 5-digit physical addresses.

We will use the address fa:e64c to explain the actions of the MMU. It is really very simple if you can do hex arithmetic in your head or have a decent calculator. The MMU takes the XPC or DATASEG value, appends three zeros to it, then adds it to the PC value, like so:

$$fa000 + e64c = 10864c$$

A sixth digit in the result is ignored, leaving us with the value 0x0864c. This is the physical address. Again, you can check this in a couple of dump windows by typing in the 5-digit physical address for one window and the XPC:offset into another and seeing that the contents are the same.

## 6.2.10 Symbolic Stack Trace

Dynamic C has both a Stack window and a Stack Trace window. The Stack window lets you view the top 32 bytes of the stack. The Stack Trace window lets you see where you are and how you got there. It keeps a running depth value, telling you how many bytes have been pushed on the stack in the current program instance, or since the depth value reset button was clicked. The Stack Trace window only tracks stack-based variables, i.e., auto variables. The storage class for local variables can be either auto or static, specified through a modifier when the variable is declared or globally via the #class directive. Whatever the means, if a local variable is marked static it will not appear in the Stack Trace window.

- Pros** Provides a concise history of the call sequence and values of local variables and function arguments that led to the current breakpoint, all for a very small cost in execution time and BIOS memory.
- Cons** Currently, the Stack Trace window can not trace the parameters and local variables in cofunctions. Also the contents of the window can not be saved after a program crash.
- Uses** Use stack tracing to capture the call sequence leading to a breakpoint and to see the values of functions arguments and local variables.
- Example** Say you have a function that is behaving badly. You can set a breakpoint in the function and use the Stack Trace window to examine the function call sequence. Examining the call sequence and the parameters being passed might give enough information to solve the problem.

The following screenshot shows an instance of `qsortdemo.c` and the Stack Trace window. Note that the call to `memcpy()` is not represented on the stack. The reason is that its stack activity had completed and program execution had returned to `main()` when the stack was traced at the breakpoint in the function `mycmp()`.

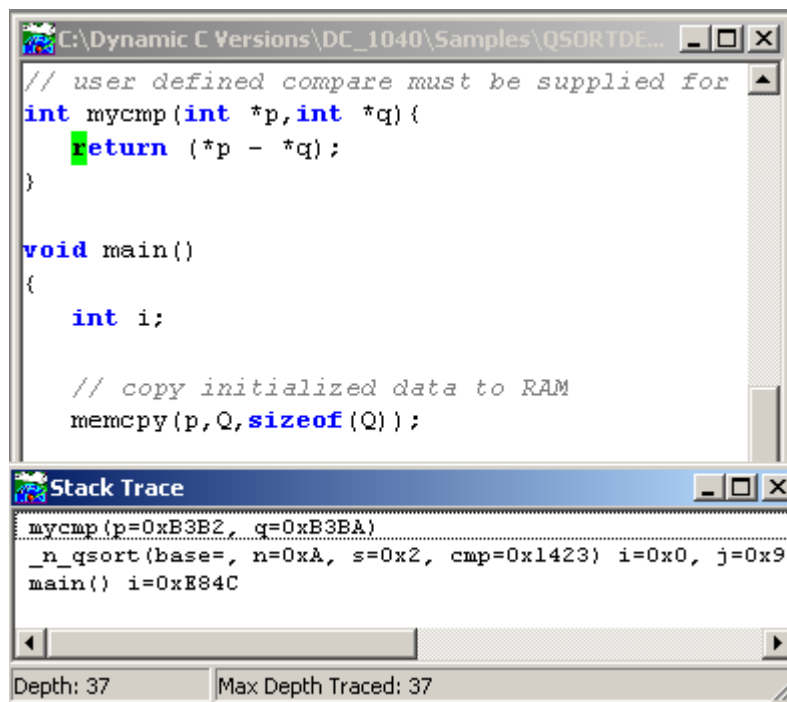

The screenshot shows a window titled "C:\Dynamic C Versions\DC\_1040\Samples\QSORTDE..." containing C code. The code defines a function `mycmp` and a `main` function. A breakpoint is set on the `return` statement in `mycmp`. Below the code is a "Stack Trace" window showing the call sequence: `mycmp(p=0xB3B2, q=0xB3BA)`, `_n_qsort(base=, n=0xA, s=0x2, cmp=0x1423) i=0x0, j=0x9`, and `main() i=0xE84C`. The stack trace window also shows "Depth: 37" and "Max Depth Traced: 37".

```
// user defined compare must be supplied for
int mycmp (int *p, int *q) {
 return (*p - *q);
}

void main()
{
 int i;

 // copy initialized data to RAM
 memcpy(p, Q, sizeof(Q));
}
```

Stack Trace

```
mycmp(p=0xB3B2, q=0xB3BA)
_n_qsort(base=, n=0xA, s=0x2, cmp=0x1423) i=0x0, j=0x9,
main() i=0xE84C
```

Depth: 37 Max Depth Traced: 37

## 6.2.11 Assert Macro

The Dynamic C implementation of assert follows the ANSI standard for the NDEBUG macro, but differs in what the macro is defined to be so as to save code space (ANSI specifies that assert is defined as `((void)0)` when NDEBUG is defined, but this generates a NOP in Dynamic C, so it is defined to be nothing).

**Pros** The assert macro is self-checking software. It lets you explicitly state something is true, and if it turns out to be false, the program terminates with an error message. At the time of this writing, this link contained an excellent write-up on the assert macro:

`http://www.embedded.com/story/OEG20010311S0021`

**Cons** Side effects can occur if the assert macro is not coded properly, e.g.,

```
assert(i=1)
```

will never trigger the assert and will change the value of the variable `i`; it should be coded as:

```
assert(i==1)
```

**Uses** Use the assert macro when you must make sure your assumption is accurate.

**Example** Check for a NULL pointer before using it.

```
void my_function (int * ptr){
 assert(ptr);
 ...
}
```

## 6.2.12 Miscellaneous Debugging Tools

Noted here are a number of other debugging tools to consider.

### General Debug Windows

In addition to the debug windows we have discussed already, there are three other windows that are available when a program is compiled: the Assembly, Register and Stack windows. They are described in detail in [Chapter 16](#), in the sections titled, [Assembly \(F10\)](#), [Register Window](#) and [Stack \(F12\)](#), respectively.

## xalloc\_stats()

Prints a table of physical addresses that are available for allocation in xmem via `xalloc()` calls. To display this information in the Stdio window, execute the statement:

```
xalloc_stats(0);
```

in your application or use Inspect | Evaluate Expression. The Stdio window will display something similar to the following:

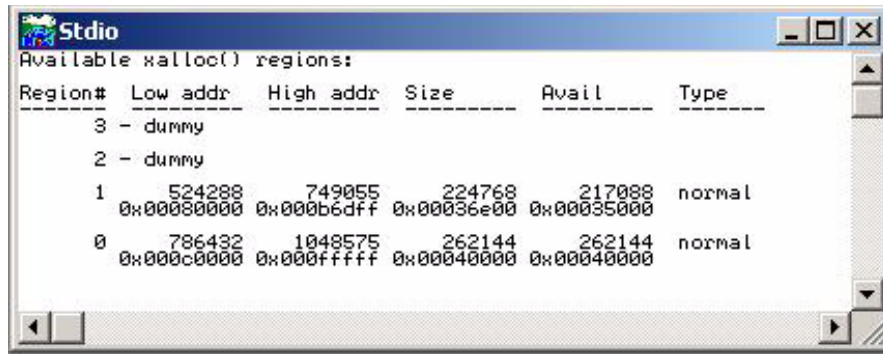

| Region# | Low addr             | High addr             | Size                 | Avail                | Type   |
|---------|----------------------|-----------------------|----------------------|----------------------|--------|
| 3       | -                    | -                     | -                    | -                    | dummy  |
| 2       | -                    | -                     | -                    | -                    | dummy  |
| 1       | 524288<br>0x00080000 | 749055<br>0x000b6dff  | 224768<br>0x00036e00 | 217088<br>0x00035000 | normal |
| 0       | 786432<br>0x000c0000 | 1048575<br>0x000fffff | 262144<br>0x00040000 | 262144<br>0x00040000 | normal |

A region is a contiguous piece of memory. Theoretically, up to four regions can exist; a region that is marked “dummy” is a region that does not exist. Each region is identified as “normal” or “BB RAM,” which refers to memory that is battery-backed.

## SerialIO.exe

The utility `serialIO.exe` is located in `\Diagnostics\Serial_IO`. It is also in the file `SerialIO_1.zip`, available for download at: [www.rabbit.com/support/downloads/](http://www.rabbit.com/support/downloads/).

This utility is a specialized terminal emulator program and comes with several diagnostic programs. The diagnostic programs test a variety of functionality, and allow the user to simulate some of the behavior of the Dynamic C download process.

The utility has a Help button that gives complete instructions for its use. The *Rabbit 4000 Designer's Handbook* in the chapter titled “Troubleshooting Tips for New Rabbit-Based Systems” explains some of the diagnostic programs that come with the `serialIO` utility. Understanding the information in this chapter will allow you to write your own diagnostic programs for the `serialIO` utility.

## reset\_demo.c

The sample program `Samples\reset_demo.c` demonstrates using the functions that check the reason for a reset: hard reset (power failure or pressing the reset button), soft reset (initiated by software), or a watchdog timeout.

## Error Logging

Chapter 9, “Run-Time Errors,” describes the exception handling routine for run-time errors that is supplied with Dynamic C. The default handler may be replaced with a user-defined handler. Also error logging can be enabled by setting `ENABLE_ERROR_LOGGING` to 1 in `ERRLOGCONFIG.LIB`. Error logging is no longer supported as of Dynamic C 10.40.

## Watchdogs

Ten virtual watchdogs are provided, in addition to the hardware watchdog(s) of the processor. Watchdogs, whether hardware or software, limit the amount of time a system is in an unknown state.

Virtual watchdogs are maintained by the Virtual Driver and described in [Section 7.4.2](#). The sample program `Samples\VDriver\VIRT_WD.C` demonstrates the use of a virtual watchdog.

## Compiler Options

The Compiler tab of the Project Options dialog contains several options that assist debugging. They are summarized here and fully documented starting on [page 282](#).

- **List Files** - When enabled, this option generates an assembly list file for each compile. The list file contains the same information and is in the same format as the contents of the [Assembly window](#). List files can be very large.
- **Run-Time Checking** - Run-time checking of array indices and pointers are enabled by default. Run-time pointer checking is no longer available as of Dynamic C 10.50.
- **Type Checking** - Compile-time checking of type options are enabled by default. There are three type checking options, labeled as: Prototype, Demotion and Pointer. Checking prototypes means that arguments passed in function calls are checked against the function prototype. Demotion checking means that the automatic conversion of a type to a smaller or less complex type is noted. Pointer checking refers to making sure pointers of different types being intermixed are cast properly.

See the section titled, [“Type Checking” on page 283](#) for more information.

## Blinking Lights

Debugging software by toggling LEDs on and off might seem like a strange way to approach the problem, but there are a number of situations that might call for it. Maybe you just want to exercise the board hardware. Or, let us say you need to see if a certain piece of code was executed, but the board is disconnected from your computer and so you have no way of viewing `printf` output or using the other debugging tools. Or, maybe timing is an issue and directly toggling an LED with a call to `WRPortE()` or `BitWRPortE()` gives you the information you need without as much affect on timing.

## 6.3 Where to Look for Debugger Features

Debugger features are accessed from several different Dynamic C menus. The menu to look in depends on whether you want to enable, configure, view or use the debugger feature. This section identifies the various menus that deal with debugging. Table 6-2 summarizes the menus and debugging tools.

**Table 6-2. Summary of Debug Tools and Menus**

| Name of Feature                   | Where Feature is Configured                                             | Where Feature is Enabled                                   | Where Feature is Toggled <sup>a</sup>                                                    |
|-----------------------------------|-------------------------------------------------------------------------|------------------------------------------------------------|------------------------------------------------------------------------------------------|
| Symbolic Stack Trace              | Environment Options, Debug Windows tab                                  | Project Options, Debugger tab                              | Windows Menu                                                                             |
| Software Breakpoints              | Project Options, Debugger tab                                           | Project Options, Debugger tab                              | Run Menu                                                                                 |
| Hardware Breakpoints              | “Add   Edit Hardware breakpoint” dialog                                 | Run menu’s “Add/Edit Hardware Breakpoints” option          | In “Add   Edit Hardware breakpoint” dialog, change check box, then click “Update” button |
| Single Stepping                   | No configuration options                                                | Always enabled                                             | Run Menu                                                                                 |
| Instruction Level Single Stepping | No configuration options                                                | Project Options, Debugger tab                              | Run Menu                                                                                 |
| Watch Expressions                 | Environment Options, Debug Windows tab<br>Project Options, Debugger tab | Project Options, Debugger tab                              | Inspect Menu                                                                             |
| Evaluate Expression               | No configuration options                                                | This feature is enabled when Watch Expressions is enabled. | Inspect Menu                                                                             |
| Map File                          | No configuration options                                                | Always enabled                                             | Automatically generated for compiled programs                                            |
| Memory Dump                       | Environment Options, Debug Windows tab                                  | Always enabled                                             | Inspect Menu                                                                             |
| Disassemble Code                  | Environment Options, Debug Windows tab                                  | Always enabled                                             | Inspect Menu                                                                             |
| Assert Macro                      | Programmatically                                                        | Programmatically                                           | Programmatically                                                                         |
| printf()                          | Programmatically                                                        | Programmatically                                           | Programmatically                                                                         |
| Stdio, Stack and Register windows | Environment Options, Debug Windows tab                                  | Always enabled                                             | Windows Menu                                                                             |

a. Keyboard shortcuts and toolbar menu buttons are shown along with their corresponding menu commands in the dropdown menus.

### 6.3.1 Run and Inspect Menus

The Run and Inspect menus are covered in detail in [Section 16.5](#) and [Section 16.6](#), respectively. These menus are where you can enable the use of several debugger features. The Run menu has options for toggling breakpoints and for single stepping. The Inspect menu has options for manipulating watch expressions, disassembling code and for dumping memory. For the most part, a debugger feature must be enabled before it can be selected in the Run or Inspect menus (or by its keyboard shortcut or toolbar menu button). Most debugger features are enabled by default in the Project Options dialog. The disassembled code and memory dump options are the exception, as they are always available to a compiled program.

### 6.3.2 Options Menu

From the Options menu in Dynamic C you can select Environment Options, Project Options or Toolbars, where you configure debug windows, enable debug tools or customize your toolbar buttons, respectively.

The Environment Options dialog has a tab labeled “Debug Windows.” There are a number of configuration options available there. You can choose to have all or certain debug windows open automatically when a program compiles. You can choose font and color schemes for any debug window. More important than fonts and colors, you can configure most of the debug windows in ways specific to that window. For example, for the Assembly window you can alter which information fields are visible. See the section titled, “[Debug Windows Tab](#)” on [page 272](#) for complete information on the specific options available for each window.

The Project Options dialog has a tab labeled “Debugger.” This is where symbolic stack tracing, breakpoints, watch expressions and instruction level single stepping are enabled. These debugging tools must be enabled before they can be used. Some configuration options are also set on the Debugger tab. See the section titled, “[Debugger Tab](#)” on [page 288](#), for complete information on the configuration options available on the Debugger tab.

The final menu selection on the Options menu is labeled, “Toolbars.” This is where you choose the toolbars and the menu buttons that appear on the control bar. See the section titled, “[Toolbars](#)” on [page 294](#), for instructions on customizing this area. Placing the menu buttons you use the most on the control bar is not really a debugging tool, but may make the task easier by offering some convenience.

### 6.3.3 Window Menu

The Window menu is where you can toggle display of debug windows. See [Section 16.8](#) for more information. Another selection available from the Window menu is the Information window, which contains memory information and the status of the last compile. See “Information” on [page 301](#) for full details.

## 6.4 Debug Strategies

Since bug-free code is a trade-off with time and money, we know that software has bugs<sup>i</sup>. This section discusses ways to minimize the occurrence of bugs and gives you some strategies for finding and eliminating them when they do occur.

### 6.4.1 Good Programming Practices

There is a big difference between “buggy code” and code that runs with near flawless precision. The latter program may have a bug, but it may be a relatively minor problem that only appears under abnormal circumstances. (This touches on the subject of testing, which are the actions taken specifically to find bugs, a larger discussion that is beyond the scope of this chapter.) This section discusses some time-tested methods that may improve your ability to write software with fewer bugs.

- **The Design:** The design is the solution to the problem that a program or function is supposed to solve. At a high level, the design is independent of the language that will be used in the implementation. Many questions must be asked and answered. What are the requirements, the boundaries, the special cases? These things are all captured in a well thought out design document. The design, written down, not just an idea floating in your head, should be rigorous, complete and detailed. There should be agreement and sign-off on the design before any coding takes place. The design underlies the code—it must come first. This is also the first part of creating full documentation.
- **Documentation:** Other documentation includes code comments and function description headers, which are specially formatted comments. Function description headers allow functions from libraries listed in `lib.dir` to be displayed in the Function Lookup option in Dynamic C’s Help menu (or by using the keyboard shortcut Ctrl+H). See [Section 4.11](#) for details on creating function description headers for user-defined library functions.

Another way to comment code is by making the code self-documenting: Always choose descriptive names for functions, variables and macros. The brain only has so much memory capacity, and there is no need to waste it by requiring yourself to remember that `cwl()` is the function to call when you want to check the water level in your fish tank; `chk_h20_level()`, for example, makes it easier to remember the function’s purpose. Of course, you get very familiar with code while it is in development and so your brain transforms the letters “cwl” quite easily to the words “check water level.” But years later when some esoteric bug appears and you have to dig into old code, you might be glad you took the time to type out some longer function names.

- **Modular Code:** If you have a function that checks the water level in the fish tank, don’t have the same function check the temperature. Keep functions focused and as simple as possible.

---

i. For an account of what can happen when time and money constraints all but disappear, read [“They Write the Right Stuff”](#) by Charles Fishman.

- **Coding Standards:** The use of coding standards increases maintainability, portability and re-use of code. In Dynamic C libraries and sample programs<sup>i</sup> some of the standards are as follows:
  - Macros names are capitalized with an underscore separating words, e.g., MY\_MACRO.
  - Function names start with a lowercase letter with an underscore or a capital letter separating words, e.g., my\_function() or myFunction().
  - Use parenthesis. Do not assume everyone has memorized the rules of precedence. E.g.,
 

```
y = a * b << c; // this is legal
y = (a * b) << c; // but this is more clear
```
  - Use consistent indenting. This increases readability of the code. Look in the [Editor tab](#) in the Environment Options dialog to turn on a feature that makes this automatic.
  - Use block comments (`/*...*/`) only for multiple line comments on the global level and line comments (`//`) inside functions, unless you really need to insert a long, multiple line comment. The reason for this is it is difficult to temporarily comment out sections of code using `/*...*/` when debugging if the section being commented out has block comments, since block comments are not nestable.
  - Use Dynamic C code templates to minimize syntax errors and some typos. Look in the [Code Templates tab](#) in the Environment Options dialog to modify existing templates or create you own. Right click in an editor window and select Insert Code Template from the popup menu. This will bring up a scroll box containing all the available templates from which to choose.
- **Syntax Highlighting:** Many syntactic elements are visually enhanced with color or other text attributes by default. These elements are user-configurable from the [Syntax Colors tab](#) of the Environment Options dialog. This is more than mere lipstick. The visual representation of material can aid in or detract from understanding it, especially when the material is complex.
- **Revision Control System:** If your company has a code revision control systems in place, use it. In addition, when in development or testing stages, keep a known good copy of your program close at hand. That is, a compiles-and-runs-without-crashing copy of your program. Then if you make changes, improvements or whatever and then can't compile, you can go back to the known good copy.

---

i. Older libraries may not adhere strictly to these standards.

## 6.4.2 Finding the Bug

When a program does not compile, or compiles, but when running behaves in unexpected ways, or perhaps worse, runs and then crashes, what do you do?

Compilation failures are caused by syntax errors. The compiler will generate messages to help you fix the problem. There may be a list of compiler error messages in the window that pops up. Fix the first one, then recompile. The other compile errors may disappear if they were not true syntax errors, but just the compiler being confused from the first syntax error.

During development, verify code as you progress. Develop code one function at a time. Do not wait until you are finished with your implementation before you attempt to compile and run it, unless it is a very short application. After a program is compiled, other types of bugs have a chance to reveal themselves. The rest of this section concentrates on how to find a bug.

### 6.4.2.1 Reproduce the Problem

Keep an open mind. It might not be a bug in the software: you might have a bad cable connection, or something along those lines. Check and eliminate the easy things first. If you are reasonably sure that your hardware is in good working order, then it is time to debug the software.

Some bugs are consistent and are easy to reproduce, which means it will be easier to gather the information needed to solve the problem. Other bugs are more elusive. They might seem random, happening only on Wednesdays, or some other seemingly bizarre behavior. There are a number of reasons why a bug may be intermittent. Here are some common one:

- Memory corruption
  - uninitialized or incorrectly initialized pointers
  - buffer overflow
  - Stack overflow/underflow
- ISR modifying but not saving infrequently used register
- Interrupt latency
- Other borderline timing issues
- EMI

One of the difficulties of debugging is that the source of a bug and its effect may not appear closely related in the code. For example, if an array goes out of bounds and corrupts memory, it may not be a problem until much later when the corrupted memory is accessed.

### 6.4.2.2 Minimize the Failure Scenario

After you can reproduce the bug, create the shortest program possible that demonstrates the problem. Whatever the size of the code you are debugging, one way to minimize the failure scenario is a method called “binary search.” Basically, comment out half the code (more or less) and see which half of the program the bug is in. Repeat until the problem is isolated.

### 6.4.2.3 Other Things to Try

Get out of your cubicle. It is a well-known fact that there are times when simply walking over to a co-worker and explaining your problem can result in a solution. Probably because it is a form of data gathering. The more data you gather (up to a point), the more you know, and the more you know, the more your chances of figuring out the problem increase.

Stay in your cubicle. Log on and get involved in one of the online communities. There is a great Yahoo E-group dedicated to Rabbit and Dynamic C. Although Rabbit engineers will answer questions there, it is mostly the members of this group that solve problems for each other. To join this group go to:

<http://tech.groups.yahoo.com/group/rabbit-semi/>

Another good online source of information and help is the Rabbit bulletin board. Go to:

[www.rabbit.com/support/bb/](http://www.rabbit.com/support/bb/)

If you are having trouble figuring out what is happening, remember to analyze the bug under various conditions. For example, run the program without the programming cable attached. Change the baud rate. Change the processor speed. Do bug symptoms change? If they do, you have more clues.

## 6.5 Reference to Other Debugging Information

There are many good references available. Here are a few of them:

- *Debugging Embedded Microprocessor Systems*, Stuart Ball
- *Writing Solid Code*, by Steve Macquire
- Websites: google, search on *debugging software*

At the time of this writing the following links provided some good information:

<http://www.embeddedstar.com/technicalpapers/content/d/embedded1494.html>

“They Write the Right Stuff” by Charles Fishman

<http://www.fastcompany.com/online/06/writestuff.html>

# 7. THE VIRTUAL DRIVER

Virtual Driver is the name given to some initialization services and a group of services performed by a periodic interrupt. These services are:

## Initialization Services

- Call `_GLOBAL_INIT()`
- Initialize the global timer variables
- Start the Virtual Driver periodic interrupt

## Periodic Interrupt Services

- Decrement software (virtual) watchdog timers
- Hitting the hardware watchdog timer
- Increment the global timer variables
- Drive uC/OS-II preemptive multitasking
- Drive slice statement preemptive multitasking

## 7.1 Default Operation

The user should be aware that by default the Virtual Driver starts and runs in a Dynamic C program without the user doing anything. This happens because before `main()` is called, a function called `premain()` is called by the Rabbit kernel (BIOS) that actually calls `main()`. Before `premain()` calls `main()`, it calls a function named `VdInit()` that performs the initialization services, including starting the periodic interrupt. If the user were to disable the Virtual Driver by commenting out the call to `VdInit()` in `premain()`, then none of the services performed by the periodic interrupt would be available. Unless the Virtual Driver is incompatible with some very tight timing requirements of a program and none of the services performed by the Virtual Driver are needed, it is recommended that the user not disable it.

## 7.2 Calling `_GLOBAL_INIT()`

`VdInit()` calls the function chain `_GLOBAL_INIT()` which runs all `#GLOBAL_INIT` sections in a program. `_GLOBAL_INIT()` also initializes all of the CoData structures needed by costatements and cofunctions. If `VdInit()` is not called, users could still use costatements and cofunctions if the call to `VdInit()` was replaced by a call to `_GLOBAL_INIT()`, but the `DelaySec()` and `DelayMs()` functions often used with costatements and cofunctions in `waitfor` statements would not work because those functions depend on timer variables which are maintained by the periodic interrupt.

## 7.3 Global Timer Variables

SEC\_TIMER, MS\_TIMER and TICK\_TIMER are global variables defined as **shared** unsigned long. These variables should never be changed by an application program. Among other things, the TCP/IP stack depends on the validity of the timer variables.

On initialization, SEC\_TIMER is synchronized with the real-time clock. The date and time can be accessed more quickly by reading SEC\_TIMER than by reading the real-time clock.

The periodic interrupt updates SEC\_TIMER every second, MS\_TIMER every millisecond, and TICK\_TIMER 1024 times per second (the frequency of the periodic interrupt). These variables are used by the DelaySec, DelayMS and DelayTicks functions, but are also convenient for application programs to use for timing purposes.

### 7.3.1 Example: Timing Loop

The following sample shows the use of MS\_TIMER to measure the execution time in microseconds of a Dynamic C integer add. The work is done in a **nodebug** function so that debugging does not affect timing.

```
#define N 10000
main(){ timeit(); }
nodebug timeit(){
unsigned long int T0;
float T2,T1;
int x,y;
int i;

T0 = MS_TIMER;
for(i=0;i<N;i++) { }

// T1 gives empty loop time
T1=(MS_TIMER-T0);

T0 = MS_TIMER;
for(i=0;i<N;i++){ x+y;}

// T2 gives test code execution time
T2=(MS_TIMER-T0);

// subtract empty loop time and convert to time for single pass
T2=(T2-T1)/(float)N;

// multiply by 1000 to convert milliseconds to microseconds.
printf("time to execute test code = %f us\n",T2*1000.0);
}
```

### 7.3.2 Example: Delay Loop

An important detail about `MS_TIMER` is that it overflows (“rolls over”) approximately every 49 days, 17 hours. This behavior causes the following delay loop code to fail:

```
/* THIS CODE WILL FAIL!! */
endtime = MS_TIMER + delay;
while (MS_TIMER < endtime) {
 //do something
}
```

If “`MS_TIMER + delay`” overflows, this returns immediately. The correct way to code the delay loop so that an overflow of `MS_TIMER` does not break it, is this:

```
endtime = MS_TIMER + delay;
while ((long)MS_TIMER - endtime < 0) {
 //do something
}
```

The interval defined by the subtraction is always correct. This is true because the value of the interval is based on the values of `MS_TIMER` and “`endtime`” relative to one another, so the actual value of these variable does not matter.

One way to conceptualize why the second code snippet is always correct is to consider a number circle like the one in Figure 7.1. In this example, `delay=5`. Notice that the value chosen for `MS_TIMER` will “roll over” but that it is only when `MS_TIMER` equals or is greater than “`endtime`” that the while loop will evaluate to false.

Figure 7.1 `delay=5`

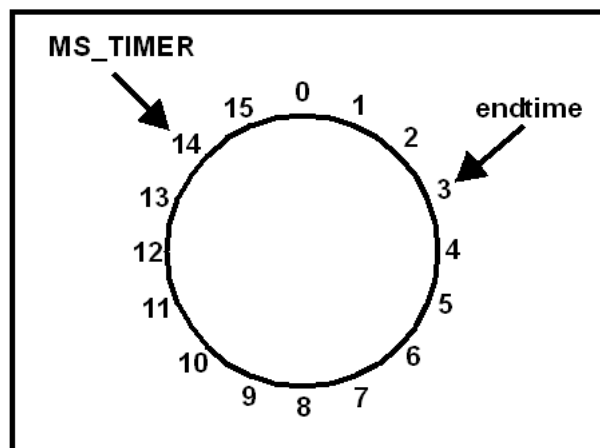

Another important point to consider is that the interval is cast to a signed number, which means that any number with the high bit set is negative. This is necessary in order for the interval to be less than zero when `MS_TIMER` is a large number.

## 7.4 Watchdog Timers

Watchdog timers limit the amount of time your system will be in an unknown state.

### 7.4.1 Hardware Watchdog

The Rabbit CPU has two built-in hardware watchdog timers, called the watchdog timer (WDT) and the secondary watchdog timer (SWDT). The Virtual Driver hits the watchdog timer (WDT) periodically. The following code fragment could be used to disable this WDT:

```
#asm
 ld a,0x51
ioi ld (WDTTR),a
 ld a,0x54
ioi ld (WDTTR),a
#endasm
```

However, it is recommended that the watchdog not be disabled. The watchdog prevents the target from entering an endless loop in software due to coding errors or hardware problems. If the Virtual Driver is not used, the user code should periodically call `hitwd()`.

When debugging a program, if the program is stopped at a breakpoint because the breakpoint was explicitly set, or because the user is single stepping, then the debug kernel hits the hardware watchdog periodically.

The secondary watchdog timer defaults to disabled. For more information on the hardware watchdogs, please see the user's manual for your Rabbit processor.

### 7.4.2 Virtual Watchdogs

There are 10 virtual WDTs available; they are maintained by the Virtual Driver. Virtual watchdogs, like the hardware watchdog, limit the amount of time a system is in an unknown state. They also narrow down the problem area to assist in debugging.

The function `VdGetFreeWd(count)` allocates and initializes a virtual watchdog. The return value of this function is the ID of the virtual watchdog. If an attempt is made to allocate more than 10 virtual WDTs, a fatal error occurs. In debug mode, this fatal error will cause the program to return with error code 250. The default run-time error behavior is to reset the board.

The ID returned by `VdGetFreeWd()` is used as the argument when calling `VdHitWd(ID)` to hit a virtual watchdog or `VdReleaseWd(ID)` to deallocate it.

The Virtual Driver counts down watchdogs every 62.5 ms. If a virtual watchdog reaches 0, this is fatal error code 247. Once a virtual watchdog is active, it should be reset periodically with a call to `VdHitWd(ID)` to prevent this. If `count = 2` for a particular WDT, then `VdHitWd(ID)` will need to be called within 62.5 ms for that WDT. If `count = 255`, `VdHitWd(ID)` will need to be called within 15.94 seconds.

The Virtual Driver does not count down any virtual WDTs if the user is debugging with Dynamic C and stopped at a breakpoint.

## 7.5 Preemptive Multitasking Drivers

A simple scheduler for Dynamic C's preemptive [slice statement](#) is serviced by the Virtual Driver. The scheduling for  $\mu$ C/OS-II, a more traditional full-featured real-time kernel, is also done by the Virtual Driver.

*These two scheduling methods are mutually exclusive—slicing and  $\mu$ C/OS-II must not be used in the same program.*

## 8. THE SLAVE PORT DRIVER

The Rabbit family of microprocessors has hardware for a slave port, allowing a master controller to read and write certain internal registers on the Rabbit. The library, `Slaveport.lib`, implements a complete master/slave protocol for the Rabbit slave port. Sample libraries, `Master_serial.lib` and `Sp_stream.lib` provide serial port and stream-based communication handlers using the slave port protocol.

### 8.1 Slave Port Driver Protocol

Given the variety of embedded system implementations, the protocol for the slave port driver was designed to make the software for the master controller as simple as possible. Each interaction between the master and the slave is initiated by the master. The master has complete control over when data transfers occur and can expect single, immediate responses from the slave.

#### 8.1.1 Overview

1. Master writes to the command register after setting the address register and, optionally, the data register. These registers are internal to the slave.
2. Slave reads the registers that were written by the master.
3. Slave writes to command response register after optionally setting the data register. This also causes the SLAVEATTN line on the Rabbit slave to be pulled low.
4. Master reads response and data registers.
5. Master writes to the slave port status register to clear interrupt line from the slave.

## 8.1.2 Registers on the Slave

From the point of view of the master, the slave is an I/O device with four register addresses.

**Table 8-1. The slave registers that are accessible by the master**

| Register Name | Internal Address of Register | Address of Register From Master's Perspective | Register Use                                                                                                                                                                                                                                         |
|---------------|------------------------------|-----------------------------------------------|------------------------------------------------------------------------------------------------------------------------------------------------------------------------------------------------------------------------------------------------------|
| SPD0R         | 0x20                         | 0                                             | Command and response register                                                                                                                                                                                                                        |
| SPD1R         | 0x21                         | 1                                             | Address register                                                                                                                                                                                                                                     |
| SPD2R         | 0x22                         | 2                                             | Optional data register                                                                                                                                                                                                                               |
| SPSR          | 0x23                         | 3                                             | Slave port status register. In this protocol the only bit used is for checking the command response register. Bit 3 is set if the slave has written to SPD0R. It is cleared when the master writes to SPSR, which also deasserts the SLAVEATTN line. |

Accessing the same address (0, 1 or 2) uses two different registers, depending on whether the access was a read or a write. In other words, when writing to address 0, the master accesses a different location than when it reads address 0.

**Table 8-2. What Happens When the Master Accesses a Slave Register**

| Register Address | Read                               | Write                                           |
|------------------|------------------------------------|-------------------------------------------------|
| 0                | Gets command response from slave   | Sends command to slave, triggers slave response |
| 1                | Not used                           | Sets channel address to send command to         |
| 2                | Gets returned data from slave      | Sets data byte to send to slave                 |
| 3                | Gets slave port status (see below) | Clears slave response bit (see below)           |

The status port is a bit field showing which slave port registers have been updated. For the purposes of this protocol. Only bit 3 needs to be examined. After sending a command, the master can check bit 3, which is set when the slave writes to the response register. At this point the response and returned data are valid and should be read before sending a new command. Performing a dummy write to the status register will clear this bit, so that it can be set by the next response.

Pin assignments for the Rabbit acting as a slave are as follows:

**Table 8-3. Pin Assignments for the Rabbit Acting as a Slave**

| Rabbit 4000 Pins<br>Rabbit 5000 Pins | Function                                                                                             |
|--------------------------------------|------------------------------------------------------------------------------------------------------|
| PA0-PA7                              | Slave port data bus, bidirectional                                                                   |
| PB6                                  | /SCS Slave Chip Select (active low to read/write slave port)                                         |
| PE7                                  | /SCS Alternate Slave Chip Select                                                                     |
| PB2                                  | /SWR Slave Write (assert for write cycle)                                                            |
| PB3                                  | /SRD Slave Read (assert for read cycle)                                                              |
| PB4                                  | SA0 low address bit for slave port registers                                                         |
| PB5                                  | SA1 high address bit for slave registers                                                             |
| PB7                                  | /SLVATTN asserted by slave when it responds to a command; cleared by master write to status register |

For more details and read/write signal timing see the microprocessor user's manual for your Rabbit chip.

### 8.1.3 Polling and Interrupts

Both the slave and the master can use interrupt or polling for the slave. The parameter passed to `SPinit()` determines which one is used. In interrupt mode, the developer can indicate whether the handler functions for the channels are interruptible or non-interruptible.

### 8.1.4 Communication Channels

The Rabbit slave has 256 configurable channels available for communication. The developer must provide a handler function for each channel that is used. Some basic handlers are available in the library `Slave_Port.lib`. These handlers will be discussed later in this chapter.

When the slave port driver is initialized, a callback table of handler functions is set up. Handler functions are added to the callback table by `SPsetHandler()`.

## 8.2 Functions

Slave\_port.lib provides the following functions:

```
SPinit()
SPsetHandler()
MyHandler()
SPtick()
SPclose()
```

---

---

### SPinit

---

---

```
int SPinit (int mode);
```

#### DESCRIPTION

This function initializes the slave port driver. It sets up the callback tables for the different channels. The slave port driver can be run in either polling mode where `SPtick()` must be called periodically, or in interrupt mode where an ISR is triggered every time the master sends a command. There are two version of interrupt mode. In the first, interrupts are reenabled while the handler function is executing. In the other, the handler function will execute at the same interrupt priority as the driver ISR.

#### PARAMETERS

|             |                                                               |
|-------------|---------------------------------------------------------------|
| <b>mode</b> | 0: For polling                                                |
|             | 1: For interrupt driven (interruptible handler functions)     |
|             | 2: For interrupt driven (non-interruptible handler functions) |

#### RETURN VALUE

1: Success  
0: Failure

#### LIBRARY

SLAVE\_PORT.LIB

---

---

## SPsetHandler

---

---

```
int SPsetHandler (char address, int (*handler)(), void
 *handler_params);
```

### DESCRIPTION

This function sets up a handler function to process incoming commands from the master for a particular slave port address.

### PARAMETERS

|                       |                                                                                                                                                                                                                                                 |
|-----------------------|-------------------------------------------------------------------------------------------------------------------------------------------------------------------------------------------------------------------------------------------------|
| <b>address</b>        | The 8-bit slave port address of the channel that corresponds to the handler function.                                                                                                                                                           |
| <b>handler</b>        | Pointer to the handler function. This function must have a particular form, which is described by the function description for <code>MyHandler ( )</code> shown below. Setting this parameter to <code>NULL</code> unloads the current handler. |
| <b>handler_params</b> | Pointer that will be saved and passed to the handler function each time it is called. This allows the handler function to be parameterized for multiple cases.                                                                                  |

### RETURN VALUE

- 1: Success, the handler was set.
- 0: Failure.

### LIBRARY

`SLAVE_PORT.LIB`

---

---

## MyHandler

---

---

```
int MyHandler (char command, char data_in, void *params);
```

### DESCRIPTION

This function is a developer-supplied function and can have any valid Dynamic C name. Its purpose is to handle incoming commands from a master to one of the 256 channels on the slave port. A handler function must be supplied for every channel that is being used on the slave port.

### PARAMETERS

|                |                                    |
|----------------|------------------------------------|
| <b>command</b> | This is the received command byte. |
| <b>data_in</b> | The optional data byte             |
| <b>params</b>  | The optional parameters pointer.   |

### RETURN VALUE

This function must return an integer. The low byte must contains the response code and the high byte contains the returned data, if there is any.

### LIBRARY

This is a developer-supplied function.

---

---

## SPTick

---

---

```
void SPTick (void);
```

### DESCRIPTION

This function must be called periodically when the slave port is used in polling mode.

### LIBRARY

SLAVE\_PORT.LIB

---

---

## SPclose

---

---

```
void SPclose(void);
```

### DESCRIPTION

This function disables the slave port driver and unloads the ISR if one was used.

### LIBRARY

SLAVE\_PORT.LIB

## 8.3 Examples

The rest of the chapter describes some useful handlers.

### 8.3.1 Status Handler

`SPstatusHandler()`, available in `Slave_port.lib`, is an example of a simple handler to report the status of the slave. To set up the function as a handler on slave port address 12, do the following:

```
SPsetHandler (12, SPstatusHandler, &status_char);
```

Sending any command to this handler will cause it to respond with a 1 in the response register and the current value of `status_char` in the data return register.

### 8.3.2 Serial Port Handler

`Slave_port.lib` contains handlers for all serial ports A, B, C and D on the slave.

`Master_serial.lib` contains code for a master using the slave's serial port handler. This library illustrates the general case of implementing the master side of the master/slave protocol.

#### 8.3.2.1 Commands to the Slave

**Table 8-4. Commands that the master can send to the slave**

| Command | Command Description                                                                                                                                                                                                        |
|---------|----------------------------------------------------------------------------------------------------------------------------------------------------------------------------------------------------------------------------|
| 1       | Transmit byte. Byte value is in data register. Slave responds with 1 if the byte was processed or 0 if it was not.                                                                                                         |
| 2       | Receive byte. Slave responds with 2 if has put a new received byte into the data return register or 0 if there were no bytes to receive.                                                                                   |
| 3       | Combined transmit/receive. The response will also be a logical OR of the two command responses.                                                                                                                            |
| 4       | Set baud factor, byte 1 (LSB). The actual baud rate is the baud factor multiplied by 300.                                                                                                                                  |
| 5       | Set baud factor, byte 2 (MSB). The actual baud rate is the baud factor multiplied by 300.                                                                                                                                  |
| 6       | Set port configuration bits                                                                                                                                                                                                |
| 7       | Open port                                                                                                                                                                                                                  |
| 8       | Close port                                                                                                                                                                                                                 |
| 9       | Get errors. Slave responds with 1 if the port is open and can return an error bitfield. The error bits are the same as for the function <code>serAgetErrors()</code> and are put in the data return register by the slave. |
| 10, 11  | Returns count of free bytes in the serial port write buffer. The two commands return the LSB and the MSB of the count respectively. The LSB(10) should be read first to latch the count.                                   |

**Table 8-4. Commands that the master can send to the slave**

| Command       | Command Description                                                                                                                                                                           |
|---------------|-----------------------------------------------------------------------------------------------------------------------------------------------------------------------------------------------|
| <b>12, 13</b> | Returns count of free bytes in the serial port read buffer. The two commands return the LSB and the MSB of the count respectively. The LSB(12) should be read first to latch the count.       |
| <b>14, 15</b> | Returns count of bytes currently in the serial port write buffer. The two commands return the LSB and the MSB of the count respectively. The LSB(14) should be read first to latch the count. |
| <b>16, 17</b> | Returns count of bytes currently in the serial port write buffer. The two commands return the LSB and the MSB of the count respectively. The LSB(16) should be read first to latch the count. |

### 8.3.2.2 Slave Side of Protocol

To set up the serial port handler to connect serial port A to channel 5 , do the following:

```
SPsetHandler (5, SPserAhandler, NULL);
```

### 8.3.2.3 Master Side of Protocol

The following functions are in `Master_serial.lib`. They are for a master using a serial port handler on a slave.

```
cof_MSgetc() MSopen()
cof_MSputc() MSputc()
cof_MSread() MSrdFree()
cof_MSwrite() MSsendCommand()
MSClose() MSread()
MSgetc() MSwrFree()
MSgetError() MSwrite()
```

---

---

## cof\_MSgetc

---

---

```
int cof_MSgetc(char address);
```

### DESCRIPTION

Yields to other tasks until a byte is received from the serial port on the slave.

### PARAMETERS

**address** Slave channel address of the serial handler.

### RETURN VALUE

Value of the received character on success.  
-1: Failure.

### LIBRARY

MASTER\_SERIAL.LIB

---

---

## cof\_MSputc

---

---

```
void cof_MSputc(char address, char ch);
```

### DESCRIPTION

Sends a character to the serial port. Yields until character is sent.

### PARAMETERS

**address** Slave channel address of serial handler.

**ch** Character to send.

### RETURN VALUE

0: Success, character was sent.  
-1: Failure, character was not sent.

### LIBRARY

MASTER\_SERIAL.LIB

---

---

## cof\_MSread

---

---

```
int cof_MSread(char address, char *buffer, int length, unsigned long
 timeout);
```

### DESCRIPTION

Reads bytes from the serial port on the slave into the provided buffer. Waits until at least one character has been read. Returns after buffer is full, or `timeout` has expired between reading bytes. Yields to other tasks while waiting for data.

### PARAMETERS

|                |                                                                   |
|----------------|-------------------------------------------------------------------|
| <b>address</b> | Slave channel address of serial handler.                          |
| <b>buffer</b>  | Buffer to store received bytes.                                   |
| <b>length</b>  | Size of buffer.                                                   |
| <b>timeout</b> | Time to wait between bytes before giving up on receiving anymore. |

### RETURN VALUE

>0: Bytes read.  
-1: Failure.

### LIBRARY

MASTER\_SERIAL.LIB

---

---

## cof\_MWrite

---

---

```
int cof_MWrite(char address, char *data, int length);
```

### DESCRIPTION

Transmits an array of bytes from the serial port on the slave. Yields to other tasks while waiting for write buffer to clear.

### PARAMETERS

|                |                                          |
|----------------|------------------------------------------|
| <b>address</b> | Slave channel address of serial handler. |
| <b>data</b>    | Array to be transmitted.                 |
| <b>length</b>  | Size of array.                           |

### RETURN VALUE

Number of bytes actually written or -1 if error.

### LIBRARY

MASTER\_SERIAL.LIB

---

---

## MSclose

---

---

```
int MSclose(char address);
```

### DESCRIPTION

Closes a serial port on the slave.

### PARAMETERS

|                |                                          |
|----------------|------------------------------------------|
| <b>address</b> | Slave channel address of serial handler. |
|----------------|------------------------------------------|

### RETURN VALUE

0: Success.  
-1: Failure.

### LIBRARY

MASTER\_SERIAL.LIB

---

---

## MSgetc

---

---

```
int MSgetc(char address);
```

### DESCRIPTION

Receives a character from the serial port.

### PARAMETERS

**address**            Slave channel address of serial handler.

### RETURN VALUE

Value of received character.  
-1: No character available.

### LIBRARY

MASTER\_SERIAL.LIB

---

---

## MSgetError

---

---

```
int MSgetError(char address);
```

### DESCRIPTION

Gets bitfield with any current error from the specified serial port on the slave. Error codes are:

SER\_PARITY\_ERROR  
SER\_OVERRUN\_ERROR

### PARAMETERS

**address**            Slave channel address of serial handler.

### RETURN VALUE

Number of bytes free: Success.  
-1: Failure.

### LIBRARY

MASTER\_SERIAL.LIB

---

---

## MSinit

---

---

```
int MSinit(int io_bank);
```

### DESCRIPTION

Sets up the connection to the slave.

### PARAMETERS

**io\_bank**            The I/O bank and chip select pin number for the slave device. This is a number from 0 to 7 inclusive.

### RETURN VALUE

1: Success.

### LIBRARY

MASTER\_SERIAL.LIB

---

---

## MSopen

---

---

```
int MSopen(char address, unsigned long baud);
```

### DESCRIPTION

Opens a serial port on the slave, given that there is a serial handler at the specified address on the slave.

### PARAMETERS

**address**            Slave channel address of serial handler.

**baud**                Baud rate for the serial port on the slave.

### RETURN VALUE

1: Baud rate used matches the argument.  
0: Different baud rate is being used.  
-1: Slave port comm error occurred.

### LIBRARY

MASTER\_SERIAL.LIB

---

---

## MSputc

---

---

```
int MSputc(char address, char ch);
```

### DESCRIPTION

Transmits a single character through the serial port.

### PARAMETERS

**address**            Slave channel address of serial handler.

**ch**                    Character to send.

### RETURN VALUE

1: Character sent.

0: Transmit buffer is full or locked.

### LIBRARY

MASTER\_SERIAL.LIB

---

---

## MSrdFree

---

---

```
int MSrdFree(char address);
```

### DESCRIPTION

Gets the number of bytes available in the specified serial port read buffer on the slave.

### PARAMETERS

**address**            Slave channel address of serial handler.

### RETURN VALUE

Number of bytes free: Success.

-1: Failure.

### LIBRARY

MASTER\_SERIAL.LIB

---

---

## MSsendCommand

---

---

```
int MSsendCommand(char address, char command, char data, char
 *data_returned, unsigned long timeout);
```

### DESCRIPTION

Sends a single command to the slave and gets a response. This function also serves as a general example of how to implement the master side of the slave protocol.

### PARAMETERS

|                      |                                                                         |
|----------------------|-------------------------------------------------------------------------|
| <b>address</b>       | Slave channel address to send command to.                               |
| <b>command</b>       | Command to be sent to the slave (see <a href="#">Section 8.3.2.1</a> ). |
| <b>data</b>          | Data byte to be sent to the slave.                                      |
| <b>data_returned</b> | Address of variable to place data returned by the slave.                |
| <b>timeout</b>       | Time to wait before giving up on slave response.                        |

### RETURN VALUE

- <sup>3</sup> 0: Response code.
- 1: Timeout occurred before response.
- 2: Nothing at that address (response = 0xff).

### LIBRARY

MASTER\_SERIAL.LIB

---

---

## MSread

---

---

```
int MSread(char address, char *buffer, int size, unsigned long
 timeout);
```

### DESCRIPTION

Receives bytes from the serial port on the slave.

### PARAMETERS

|                |                                                                         |
|----------------|-------------------------------------------------------------------------|
| <b>address</b> | Slave channel address of serial handler.                                |
| <b>buffer</b>  | Array to put received data into.                                        |
| <b>size</b>    | Size of array (max bytes to be read).                                   |
| <b>timeout</b> | Time to wait between characters before giving up on receiving any more. |

### RETURN VALUE

The number of bytes read into the buffer (behaves like `serXread()`).

### LIBRARY

MASTER\_SERIAL.LIB

---

---

## MSwrFree

---

---

```
int MSwrFree(char address);
```

### DESCRIPTION

Gets the number of bytes available in the specified serial port write buffer on the slave.

### PARAMETERS

|                |                                          |
|----------------|------------------------------------------|
| <b>address</b> | Slave channel address of serial handler. |
|----------------|------------------------------------------|

### RETURN VALUE

Number of bytes free: Success.  
-1: Failure.

### LIBRARY

MASTER\_SERIAL.LIB

---

---

## MWrite

---

---

```
int MWrite(char address, char *data, int length);
```

### DESCRIPTION

Sends an array of bytes out the serial port on the slave (behaves like `serXwrite()`).

### PARAMETERS

**address**            Slave channel address of serial handler.

**data**                Array of bytes to send.

**length**             Size of array.

### RETURN VALUE

Number of bytes actually sent.

### LIBRARY

MASTER\_SERIAL.LIB

### 8.3.2.4 Sample Program for Master

This sample program, `/Samples/SlavePort/master_demo.c`, treats the slave like a serial port.

```
#use "master_serial.lib"
#define SP_CHANNEL 0x42

char* const test_str = "Hello There";

main(){
 char buffer[100];
 int read_length;

 MSinit(0);

 // comment this line out if talking to a stream handler
 printf("open returned:0x%x\n", MSopen(SP_CHANNEL, 9600));

 while(1)
 {
 costate
 {
 wfd{cof_MSwrite(SP_CHANNEL, test_str, strlen(test_str));}
 wfd{cof_MSwrite(SP_CHANNEL, test_str, strlen(test_str));}
 }
 costate
 {
 wfd{ read_length = cof_MSread(SP_CHANNEL, buffer, 99, 10); }
 if(read_length > 0)
 {
 buffer[read_length] = 0; //null terminator
 printf("Read:%s\n", buffer);
 }
 else if(read_length < 0)
 {
 printf("Got read error: %d\n", read_length);
 }
 printf("wrfree = %d\n", MSwrFree(SP_CHANNEL));
 }
 }
}
```

### 8.3.3 Byte Stream Handler

The library, `SP_STREAM.LIB`, implements a byte stream over the slave port. If the master is a Rabbit, the functions in `MASTER_SERIAL.LIB` can be used to access the stream as though it came from a serial port on the slave.

#### 8.3.3.1 Slave Side of Stream Channel

To set up the function `SPShandler()` as the byte stream handler, do the following:

```
SPsetHandler (10, SPShandler, stream_ptr);
```

This function sets up the stream to use channel 10 on the slave.

A sample program in [Section 8.3.3.2](#) shows how to set up and initialize the circular buffers. An internal data structure, `SPStream`, keeps track of the buffers and a pointer to it is passed to `SPsetHandler()` and some of the auxiliary functions that supports the byte stream handler. This is also shown in the sample program.

#### Functions

These are the auxiliary functions that support the stream handler function, `SPShandler()`.

```
cbuf_init() SPSwrite()
cof_SPSread() SPSwrFree()
cof_SPSwrite() SPSrdFree()
SPSinit() SPSwrUsed()
SPSread()
```

---

---

### `cbuf_init`

---

---

```
void cbuf_init(char *circularBuffer, int dataSize);
```

#### DESCRIPTION

This function initializes a circular buffer.

#### PARAMETERS

|                             |                                                                                                                                    |
|-----------------------------|------------------------------------------------------------------------------------------------------------------------------------|
| <code>circularBuffer</code> | The circular buffer to initialize.                                                                                                 |
| <code>dataSize</code>       | Size available to data. The size must be 9 bytes more than the number of bytes needed for data. This is for internal book-keeping. |

#### LIBRARY

`RS232.LIB`

---

---

## cof\_SPSread

---

---

```
int cof_SPSread(SPStream *stream, void *data, int length, unsigned
 long tmout);
```

### DESCRIPTION

Reads `length` bytes from the slave port input buffer or until `tmout` milliseconds transpires between bytes after the first byte is read. It will yield to other tasks while waiting for data. This function is non-reentrant.

### PARAMETERS

|               |                                                              |
|---------------|--------------------------------------------------------------|
| <b>stream</b> | Pointer to the stream state structure.                       |
| <b>data</b>   | Structure to read from slave port buffer.                    |
| <b>length</b> | Number of bytes to read.                                     |
| <b>tmout</b>  | Maximum wait in milliseconds for any byte from previous one. |

### RETURN VALUE

The number of bytes read from the buffer.

### LIBRARY

SP\_STREAM.LIB

---

---

## cof\_SPSwrite

---

---

```
int cof_SPSwrite(SPStream *stream, void *data, int length);
```

### DESCRIPTION

Transmits `length` bytes to slave port output buffer. This function is non-reentrant.

### PARAMETERS

|               |                                          |
|---------------|------------------------------------------|
| <b>stream</b> | Pointer to the stream state structure.   |
| <b>data</b>   | Structure to write to slave port buffer. |
| <b>length</b> | Number of bytes to write.                |

### RETURN VALUE

The number of bytes successfully written to slave port.

### LIBRARY

SP\_STREAM.LIB

---

---

## SPSinit

---

---

```
void SPSinit(void);
```

### DESCRIPTION

Initializes the circular buffers used by the stream handler.

### LIBRARY

SP\_STREAM.LIB

---

---

## SPSread

---

---

```
int SPSread(SPStream *stream, void *data, int length, unsigned long
 tmout);
```

### DESCRIPTION

Reads `length` bytes from the slave port input buffer or until `tmout` milliseconds transpires between bytes. If no data is available when this function is called, it will return immediately. This function will call `SPtick()` if the slave port is in polling mode.

This function is non-reentrant.

### PARAMETERS

|               |                                                       |
|---------------|-------------------------------------------------------|
| <b>stream</b> | Pointer to the stream state structure.                |
| <b>data</b>   | Buffer to read received data into.                    |
| <b>length</b> | Maximum number of bytes to read.                      |
| <b>tmout</b>  | Time to wait between received bytes before returning. |

### RETURN VALUE

Number of bytes read into the data buffer

### LIBRARY

`SP_STREAM.LIB`

---

---

## SPSwrite

---

---

```
int SPSwrite(SPSream *stream, void *data, int length);
```

### DESCRIPTION

This function transmits length bytes to slave port output buffer. If the slave port is in polling mode, this function will call `SPtick()` while waiting for the output buffer to empty. This function is non-reentrant.

### PARAMETERS

|               |                                        |
|---------------|----------------------------------------|
| <b>stream</b> | Pointer to the stream state structure. |
| <b>data</b>   | Bytes to write to stream.              |
| <b>length</b> | Size of write buffer.                  |

### RETURN VALUE

Number of bytes written into the data buffer.

### LIBRARY

`SP_STREAM.LIB`

---

---

## SPSwrFree

---

---

```
int SPSwrFree(void);
```

### DESCRIPTION

Returns number of free bytes in the stream write buffer.

### RETURN VALUE

Space available in the stream write buffer.

### LIBRARY

`SP_STREAM.LIB`

---

---

## SPSrdFree

---

---

```
int SPSrdFree(void);
```

### DESCRIPTION

Returns the number of free bytes in the stream read buffer.

### RETURN VALUE

Space available in the stream read buffer.

### LIBRARY

SP\_STREAM.LIB

---

---

## SPSwrUsed

---

---

```
int SPSwrUsed(void);
```

### DESCRIPTION

Returns the number of bytes currently in the stream write buffer.

### RETURN VALUE

Number of bytes currently in the stream write buffer.

### LIBRARY

SP\_STREAM.LIB

---

---

## SPSrdUsed

---

---

```
int SPSrdUsed(void);
```

### DESCRIPTION

Returns the number of bytes currently in the stream read buffer.

### RETURN VALUE

Number of bytes currently in the stream read buffer.

### LIBRARY

SP\_STREAM.LIB

### 8.3.3.2 Byte Stream Sample Program

This program, /Samples/SlavePort/Slave\_Demo.c, runs on a slave and implements a byte stream over the slave port.

```
#class auto
#use "slave_port.lib"
#use "sp_stream.lib"
#define STREAM_BUFFER_SIZE 31
main()
{
 char buffer[10];
 int bytes_read;

 SPStream stream;

 // Circular buffers need 9 bytes for bookkeeping.
 char stream_inbuf[STREAM_BUFFER_SIZE + 9];
 char stream_outbuf[STREAM_BUFFER_SIZE + 9];

 SPStream *stream_ptr;

 // setup buffers
 cbuf_init(stream_inbuf, STREAM_BUFFER_SIZE);
 stream.inbuf = stream_inbuf;
 cbuf_init(stream_outbuf, STREAM_BUFFER_SIZE);
 stream.outbuf = stream_outbuf;

 stream_ptr = &stream;

 SPinit(1);

 SPsetHandler(0x42, SPShandler, stream_ptr);

 while(1)
 {
 bytes_read = SPSread(stream_ptr, buffer, 10, 10);
 if(bytes_read)
 {
 SPSwrite(stream_ptr, buffer, bytes_read);
 }
 }
}
```

## 9. RUN-TIME ERRORS

Compiled code generated by Dynamic C calls an exception handling routine for run-time errors. The exception handler supplied with Dynamic C prints internally defined error messages to a Windows message box when run-time errors are detected during a debugging session. When software runs stand-alone (disconnected from Dynamic C), such a run-time error will cause a watchdog timeout and reset. Run-time error logging is available for Rabbit-based target systems with battery-backed RAM.

### 9.1 Run-Time Error Handling

When a run-time error occurs, a call is made to `exception()`. The run-time error type is passed to `exception()`, which then pushes various parameters on the stack, and calls the installed error handler. The default error handler places information on the stack, disables interrupts, and enters an endless loop by calling the `_xexit` function in the BIOS. Dynamic C notices this and halts execution, reporting a run-time error to the user.

#### 9.1.1 Error Code Ranges

The table below shows the range of error codes used by Dynamic C and the range available for a custom error handler to use. Table 9-1 is valid prior to Dynamic C version 9.30. Starting with DC 9.30, the file `errmsg.ini` located in the root directory of Dynamic C can be edited to add descriptions for user-defined run-time errors that will be displayed by Dynamic C should the error occur.

For example, if the following entry is made in `errmsg.ini`:

```
// My custom errors
800=My own run-time error message
```

Calling “`exit(-800)`” in an application or library will cause Dynamic C to report “My own run-time error message” in a message box.

Please see [Section 9.2](#) for information on replacing the default error handler with a custom one.

## 9.1.2 Fatal Error Codes

This table lists the fatal errors generated by Dynamic C.

**Table 9-1. Dynamic C Fatal Errors**

| Error Type | Meaning                                                    |
|------------|------------------------------------------------------------|
| 127 - 227  | not used                                                   |
| 228        | Pointer store out of bounds                                |
| 229        | Array index out of bounds                                  |
| 230 - 233  | not used                                                   |
| 234        | Domain error (for example, <code>acos(2)</code> )          |
| 235        | Range error (for example, <code>tan(pi/2)</code> )         |
| 236        | Floating point overflow                                    |
| 237        | Long divide by zero                                        |
| 238        | Long modulus, modulus zero                                 |
| 239        | not used                                                   |
| 240        | Integer divide by zero                                     |
| 241        | Unexpected interrupt                                       |
| 242        | not used                                                   |
| 243        | Codata structure corrupted                                 |
| 244        | Virtual watchdog timeout                                   |
| 245        | XMEM allocation failed (xalloc call)                       |
| 246        | Stack allocation failed                                    |
| 247        | Stack deallocation failed                                  |
| 248        | not used                                                   |
| 249        | Xmem allocation initialization failed                      |
| 250        | No virtual watchdog timers available                       |
| 251        | No valid MAC address for board                             |
| 252        | Invalid cofunction instance                                |
| 253        | Socket passed as auto variable while running $\mu$ C/OS-II |
| 254 - 255  | not used                                                   |

## 9.2 User-Defined Error Handler

Dynamic C allows replacement of the default error handler with a custom error handler. This is needed to add run-time error handling that would require treatment not supported by the default handler.

A custom error handler can also be used to change how existing run-time errors are handled. For example, the floating-point math libraries included with Dynamic C are written to allow for execution to continue after a domain or range error, but the default error handler halts with a run-time error if that state occurs. If continued execution is desired (the function in question would return a value of INF or whatever value is appropriate), then a simple error handler could be written to pass execution back to the program when a domain or range error occurs, and pass any other run-time errors to Dynamic C.

### 9.2.1 Replacing the Default Handler

To tell the BIOS to use a custom error handler, call this function:

```
void defineErrorHandler(void *errfcn)
```

This function sets the BIOS function pointer for run-time errors to the one passed to it.

When a run-time error occurs, `exception()` pushes onto the stack the information detailed in the table below.

**Table 9-2. Stack Setup for Run-time Errors**

| Address | Data at address                                           |
|---------|-----------------------------------------------------------|
| SP+0    | Return address for error handler                          |
| SP+2    | Error code                                                |
| SP+4    | Additional data (user-defined)                            |
| SP+6    | XPC when <code>exception()</code> was called (upper byte) |
| SP+8    | Address where <code>exception()</code> was called from    |

Then `exception()` calls the installed error handler. If the error handler passes the run-time error to Dynamic C (i.e. it is a fatal error and the system needs to be halted or reset), then registers must be loaded appropriately before calling the `_xexit` function.

Dynamic C expects the following values to be loaded:

**Table 9-3. Register Contents Loaded by Error Handler Before Passing the Error to Dynamic C**

| Register | Expected Value                                         |
|----------|--------------------------------------------------------|
| H        | XPC when <code>exception()</code> was called           |
| L        | Run-time error code                                    |
| HL'      | Address where <code>exception()</code> was called from |

## 9.3 Run-Time Error Logging

Error logging is available as a BIOS enhancement for storing run-time exception history. It can be useful diagnosing problems in deployed Rabbit targets. To support error logging, the target must have battery-backed RAM.

Error logging is no longer supported as of Dynamic C 10.40.

### 9.3.1 Error Log Buffer

A circular buffer in extended RAM will be filled with the following information for each run-time error that occurs:

- The value of `SEC_TIMER` at the time of the error. This variable contains the number of seconds since 00:00:00 on January 1st 1980 if the real-time clock has been set correctly. This variable is updated by the periodic timer which is enabled by default. Rabbit sets the real-time clock in the factory. When the BIOS starts on boards with batteries, it initializes `SEC_TIMER` to the value in the real-time clock.
- The address where the exception was called from. This can be traced to a particular function using the MAP file generated when a Dynamic C program is compiled.
- The exception type. Please see Table 9-1 on page 132 for a list of exception types.
- The value of all registers. This includes alternate registers, SP and XPC. This is a global option that is enabled by default.
- An 8-byte message. This is a global option that is disabled by default. The default error handler does nothing with this.
- A user-definable length of stack dump. This is a global option that is enabled by default.
- A one byte checksum of the entry.

The size of the error log buffer is determined by the number of entries, the size of an entry, and the header information at the beginning of the buffer. The number of entries is determined by the macro `ERRLOG_NUM_ENTRIES` (default is 78). The size of each entry is dependent on the settings of the global options for stack dump, register dump and error message. The default size of the buffer is about 4K in extended RAM.

### 9.3.2 Initialization and Defaults

An initialization of the error log occurs when the BIOS is compiled, when cloning takes place or when the BIOS is loaded via the Rabbit Field Utility (RFU). By default, error logging is disabled.

The error log buffer contains header information as well as an entry for each run-time error. A debug start-up will zero out this header structure, but the run-time error entries can still be examined from Dynamic C using the static information in flash. The header is at the start of the error log buffer and contains:

- A status byte
- The number of errors since deployment
- The index of the last error
- The number of hardware resets since deployment
- The number of watchdog time-outs since deployment
- The number of software resets since deployment
- A checksum byte.

“Deployment” is defined as the first power up without the programming cable attached. Reprogramming the board using the programming cable, the RFU, or a RabbitLink board and starting the program again without the programming cable attached is a new deployment.

### 9.3.3 Configuration Macros

These macros are defined in `Lib\..\BIOSLIB\errlogconfig.lib`. Define these macros in your project to use them. For instructions on how to do that, see the “Defines Tab” on page 290.

#### **ENABLE\_ERROR\_LOGGING**

Default: 0. Disables error logging. Changing this to “1” enables error logging.

#### **ERRLOG\_USE\_REG\_DUMP**

Default: 1. Include a register dump in log entries. Changing this to zero excludes the register dump in log entries.

#### **ERRLOG\_STACKDUMP\_SIZE**

Default: 16. Include a stack dump of size `ERRLOG_STACKDUMP_SIZE` in log entries. Changing this to zero excludes the stack dump in log entries.

#### **ERRLOG\_NUM\_ENTRIES**

Default: 78. This is the number of entries allowed in the log buffer.

#### **ERRLOG\_USE\_MESSAGE**

Default: 0. Exclude error messages from log entries. Changing this to “1” includes 8 byte error messages in log entries. The default error handler makes no use of this feature.

### 9.3.4 Error Logging Functions

The run-time error logging API consists of the following functions:

|                              |                                                                                                                                                      |
|------------------------------|------------------------------------------------------------------------------------------------------------------------------------------------------|
| <b>errlogGetHeaderInfo</b>   | Reads error log header and formats output.                                                                                                           |
| <b>errlogGetNthEntry</b>     | Loads <code>errLogEntry</code> structure with the Nth entry from the error log buffer. <code>errLogEntry</code> is a pre-allocated global structure. |
| <b>errlogGetMessage</b>      | Returns a NULL-terminated string containing the 8 byte error message in <code>errLogEntry</code> .                                                   |
| <b>errlogFormatEntry</b>     | Returns a NULL-terminated string containing basic information in <code>errLogEntry</code> .                                                          |
| <b>errlogFormatRegDump</b>   | Returns a NULL-terminated string containing the register dump in <code>errLogEntry</code> .                                                          |
| <b>errlogFormatStackDump</b> | Returns a NULL-terminated string containing the stack dump in <code>errLogEntry</code> .                                                             |
| <b>errlogReadHeader</b>      | Reads error log header into the structure <code>errlogInfo</code> .                                                                                  |
| <b>ResetErrorLog</b>         | Resets the exception and restart type counts in the error log buffer header.                                                                         |

### 9.3.5 Examples of Error Log Use

To try error logging, follow the instructions at the top of the sample programs:

```
samples\ErrorHandling\Generate_runtime_errors.c
```

and

```
samples\ErrorHandling\Display_errorlog.c
```

# 10. MEMORY MANAGEMENT

Processor instructions can specify 16-bit addresses, giving a logical address space of 64K (65,536 bytes). Dynamic C supports a physical address space of 1 MB on all Rabbit-based boards. Dynamic C 10.21 introduces support for a physical address space of 16 MB of combined code and data on Rabbit 4000 or 5000 based boards, with up to 1 MB for code. Dynamic C has been verified to work with Rabbit-based boards with 4.5 MB of memory.

An on-chip memory management unit (MMU) translates 16-bit addresses to 24-bit memory addresses for Rabbit 4000 and 5000 based boards. Four MMU registers (SEGSIZE, STACKSEG, DATASEG and XPC) divide and maintain the logical sections and map each section onto physical memory. Any memory beyond the 16-bit address capability of the processor, whether flash or RAM, is called xmem and requires memory management techniques for access.

## 10.1 Memory Map

A typical Dynamic C memory mapping of logical and physical address space is shown in the figure below. The actual layout may be different depending on the Rabbit processor used, the board type and which compilation options are selected. For example, enabling separate I&D space will affect the memory map.

**Figure 10.1 Dynamic C Memory Mapping with a Rabbit 4000-Based Board**

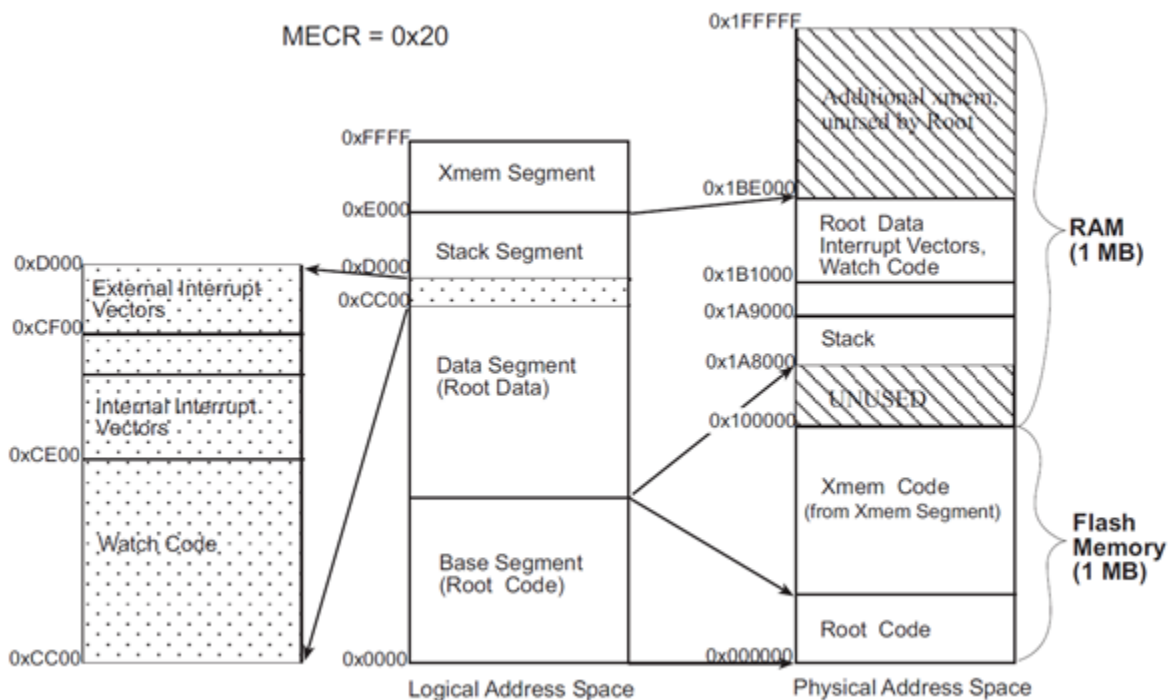

The register set provided by the Rabbit makes it easy to access the physical memory directly, bypassing the logical to physical mapping and allowing linear access of up to 16 MB. The size of the physical address space is determined by the quadrant size.

The quadrant size is determined by the MMU Expanded Code Register (MECR). This register contains the Bank Select Address setting. The Bank Select Address represents the two most significant bits of the physical address that will be used to select among the different quadrants. By default in Dynamic C 10.40, the MECR selects A20 and A19, thus leaving 19 bits for the address, which results in a quadrant size of 512 KB and a physical address space of 2 MB.

Figure 10.1 illustrates how the logical address space is divided and where code resides in physical memory. Both the static RAM and the flash memory are 1 MB in the diagram. Physical memory starts at address 0x000000 and flash memory is usually mapped to the same address. SRAM typically begins at address 0x100000.

If BIOS code runs from flash memory, the BIOS code starts in the root code section at address 0x000000 and fills upward. The rest of the root code will continue to fill upward immediately following the BIOS code. If the BIOS code runs from SRAM, the root code section, along with root data and stack sections, will start at address 0x100000.

### 10.1.1 Memory Mapping Control

The advanced user of Dynamic C can control how Dynamic C allocates and maps memory. For details on memory mapping, refer to any of the Rabbit microprocessor user's manuals or designer's handbooks. You can also refer to one of our technical notes: TN202, "Rabbit Memory Management in a Nutshell." All of these documents are available at:

[www.rabbitsemiconductor.com/docs/](http://www.rabbitsemiconductor.com/docs/)

## 10.2 Extended Memory Functions

A program can use many pages of extended memory (xmem). Under normal execution, code in xmem maps to the logical address region 0xE000 to 0xFFFF. To move blocks of data between logical memory and physical memory, you can still use the Dynamic C functions `root2xmem()`, `xmem2root()` and `xmem2xmem()`; however Dynamic C also has the "far" keyword, which makes use of physical addresses and thereby eliminates the need for `root2xmem()`, `xmem2root()` and `xmem2xmem()`.

## 10.3 Code Placement in Memory

Code runs just as quickly in extended memory as it does in root memory, but calls to and returns from the functions in extended memory take a few extra machine cycles. Code placement in memory can be changed by the keywords `xmem` and `root`, depending on the type of code:

### Pure Assembly Routines

Pure assembly functions may be placed in root memory or extended memory. Prior to Dynamic C version 7.10, pure assembly routines had to be in root memory.

## C Functions

C functions may be placed in root memory or extended memory. Access to variables in C statements is not affected by the placement of the function. Dynamic C will automatically place C functions in extended memory as root memory fills. Short, frequently used functions may be declared with the `root` keyword to force Dynamic C to load them in root memory.

### Inline Assembly in C Functions

Inline assembly code may be written in any C function, regardless of whether it is compiled to extended memory or root memory.

All static variables, even those local to extended memory functions, are placed in root memory. Keep this in mind if the functions have many variables or large arrays. Root memory can fill up quickly.

## 10.4 Dynamic Memory Allocation

A Dynamic C application can allocate a pool of memory at compile time for dynamic allocation and deallocation of fixed-size blocks at run time. A pool can be located in root or extended memory. Descriptions for all API functions for dynamic memory allocation are in the *Dynamic C Function Reference Manual*. Or use Function Lookup from the Help menu (or Ctrl+H) to gain quick access to the function descriptions from within Dynamic C.

Read the comments at the top of `\LIB\ . . \POOL.LIB` for a description of how to use dynamic memory allocation in Dynamic C.

# 11. DIRECT MEMORY ACCESS

Dynamic C version 10 introduced support for the internal DMA controller of the Rabbit 4000 microprocessor. DMA stands for “Direct Memory Access.” The DMA controller takes control of the address and data bus from the CPU so that data transfers occur without processor handling. There are eight DMA channels; a DMA channel is a system pathway for transferring data directly to or from memory and peripheral devices without using the CPU. DMA memory addresses are always physical addresses and are never translated by the MMU.

The rest of this section discusses DMA from a software perspective. For detailed information about the DMA controller, see the *Rabbit 4000 Microprocessor User’s Manual*.

## 11.1 DMA Registers and Global Resources

There are some global resources associated with all DMA channels. These resources are managed by Dynamic C libraries because it would be difficult for most users to determine their optimal usage. The library `DMA.LIB` contains all of the DMA functionality available to the user. The advanced user can manually override the library settings by directly manipulating the DMA control registers; however, this is not recommended.

The debug function `DMAprintRegs()` lets you view the values of the DMA master registers:

- `DMCR` (DMA Master Control Register) - Transfer and interrupt priority levels.
- `DMCSR` (DMA Master Control/Status Register) - DMA channel status
- `DMTCR` (DMA Master Timing Control Register) - Sets the burst size, the inter-burst timing and the relative prioritization of the channels.

For more information on Rabbit registers, click on “I/O Registers” on the Dynamic C help menu or consult the *Rabbit 4000 Microprocessor User’s Manual* (or the user’s manual specific to your Rabbit) to get information about directly manipulating the DMA registers.

## 11.2 API Functions

Dynamic C provides several API functions for use with the DMA controller that was introduced with the Rabbit 4000. These functions make it unnecessary for an application to directly manipulate the DMA registers. Complete descriptions for all DMA API functions can be found from within Dynamic C using the Function Lookup feature from the help menu (Ctrl+H); also, in the *Dynamic C Function Reference Manual*. In this section we will look at some of these functions.

The function `DMAalloc()` is called to allocate a DMA channel; the function `DMAunalloc()` is called to release it. The handle returned by `DMAalloc()` is passed to all the DMA transfer functions (see

Section 11.4) and must be passed to `DMAunalloc()` to release the channel. All eight channels are identical, with the priority between them either fixed or rotating.

The function `DMAsetParameters()` accepts parameters that set transfer and interrupt priority levels, channel priority, maximum bytes per burst and minimum clocks between bursts.

`DMAsetParameters()` must be called by an application before a DMA channel can be used; however, the channel can be allocated before `DMAsetParameters()` is called. The DMA parameters set in `DMAsetParameters()` are global, that is, they apply to all channels.

Some low-level functions are also provided for the DMA controller. These functions use the DMA channel number instead of the handle returned by `DMAalloc()`. The function `DMAhandle2chan()` provides a DMA channel number when passed a valid handle.

The low-level functions `DMAsetBufDesc()` and `DMAloadBufDesc()` work with a buffer descriptor associated with a DMA channel. A buffer descriptor is a memory structure that controls the DMA operation. It contains a control byte, a byte count for the data, a source address, a destination address and an optional link address. Low-level transfer functions are provided for use with the buffer descriptor functions. They are `DMAstartAuto()` and `DMAstartDirect()`.

Sample programs located in `Samples\Rabbit4000\DMA\` illustrate many of the API functions.

## 11.3 DMA Interrupts

An interrupt may be requested when a DMA channel has completed transferring data. All channels assert this type of interrupt at the same priority level, which can be set to level 1, 2, or 3 with a call to `DMAsetParameters()`. Whether or not an interrupt is requested at the end of a transfer is determined by flag options in the DMA transfer function. See Section 11.4.4 for more information.

Each channel has its own interrupt vector in the processor's external interrupt vector table.

## 11.4 DMA Transfer Information

A DMA transfer is requested when the channel wants the DMA controller to take control of the address and data buses.

### 11.4.1 DMA Transfer Priority

DMA transfers may be programmed to occur at any priority level (0, 1, 2, or 3). Relative prioritization among the DMA channels is set using one of the following constants:

- **DMA\_IDP\_FIXED** - fixed priorities, with higher channel numbers taking precedence
- **DMA\_IDP\_ROTATE\_FINE** - priorities are rotated after every byte transferred
- **DMA\_IDP\_ROTATE\_COARSE** - priorities rotated after every transfer request, the size of which is determined by "chunkiness," another parameter also passed to the function `DMAsetParameters()`.

The DMA transfer priority and the relative prioritization among channels are set in `DMAsetParameters()`.

## 11.4.2 DMA Transfer Mode

DMA transfers can happen in burst or single-cycle mode. The “chunkiness” parameter passed to the DMA transfer function determines the burst size.

## 11.4.3 DMA Transfer Functions

There are three types of transfers, with associated transfer functions.

1. Memory-to-memory transfers. Use `DMAmem2mem()`.
2. Internal I/O address transfers to or from memory. Use `DMAioi2mem()` and `DMAmem2ioi()`, respectively.
3. External I/O address transfers to or from memory. Use `DMAioe2mem()` and `DMAmem2ioe()`, respectively.

## 11.4.4 DMA Transfer Function Flags

The DMA transfer functions accept the following flags:

- **DMA\_F\_REPEAT** - transfer will be a cycle.
- **DMA\_F\_INTERRUPT** - indicates an interrupt will be triggered at the completion of the transfer.
- **DMA\_F\_LAST\_SPECIAL** - (only for Ethernet or HDLC peripherals) Internal Source: Status byte written to initial buffer descriptor before last data. Internal Destination: Last byte written to offset address for frame termination.
- **DMA\_F\_SRC\_DEC** - only for transfers with memory source. Indicates the source address should be decremented. (If not specified, a memory source address is incremented.)
- **DMA\_F\_DEST\_DEC** - only for transfers with memory destination. Indicates the destination address should be decremented. (If not specified, a memory destination address is incremented.)
- **DMA\_F\_STOP\_MATCH** - indicates whether or not to stop the DMA transfer when a character is reached. The match byte and mask should have been set previously by calling the `DMAmatchSetup()` function.
- **DMA\_F\_TIMER** - indicates the DMA timer will be used. Set the divisor first by calling the `DMAtimerSetup()` function. `DMA_F_TIMER_1BPR` indicates that the timed transfers will send one byte per request instead of the entire descriptor.

## 11.5 DMA with Ethernet

Use of the Rabbit 4000 Ethernet imposes some restrictions on the global DMA settings. It is recommended that applications make use of the DMA API functions to avoid possibly breaking Ethernet by using DMA settings that are not compatible with the Ethernet restrictions. For example, Ethernet uses DMA channels 6 and 7 and fixed prioritization among the channels. There are also requirements regarding burst size and the minimum time between bursts. If you are using Ethernet and call the function `DMAsetParameters()` with parameters that are not compatible with the Ethernet restrictions, those parameters will be quietly ignored.

## 12. FAT FILE SYSTEM

Dynamic C comes with a FAT (File Allocation Table) file system. The small footprint of this well-defined industry-standard file system makes it ideal for embedded systems. The Dynamic C implementation of FAT has a directory structure that can be accessed with either Unix or DOS style paths. The standard directory structure allows monitoring, logging, Web browsing, and FTP updates of files.

The Dynamic C implementation of FAT supports both SPI-based serial flash devices and NAND flash devices. FAT version 2.13 adds support for SD cards and requires Dynamic C 10.21 or later. In all versions of the FAT, a battery-backed write-back cache reduces wear on the flash device and a round-robin cluster assignment helps spread the wear over its surface.

Please be sure check the Rabbit website for software patches and updates to Dynamic C, the FAT filesystem, and for your specific hardware:

[www.rabbit.com/support/downloads/](http://www.rabbit.com/support/downloads/)

The FAT library can be used in either *blocking* or *non-blocking* mode and supports both FAT12<sup>i</sup> and FAT16. (See [Section 12.5.3.1](#) for more information on these FAT types.)

Operations performed by the Dynamic C FAT implementation are:

- Formatting and partitioning of devices
- Formatting partitions
- File operations: create, open, close, delete, seek, read and write
- Directory<sup>ii</sup> operations: create, read and delete
- Labels: create and delete

Let's define some terms before continuing.

A *device* is a single physical hardware item such as a hard drive, a serial flash or a NAND flash. E.g., one serial flash is a single *device*. The device, in turn, can host one to four *partitions*.

A *partition* is a range of logical sectors on a device. A real-world example of a partition is what is commonly known as the C drive on a PC.

*Blocking* is a term that describes a function's behavior in regards to completion of the requested task. A blocking function will not return until it has completely finished its task. In contrast, a *non-blocking* function will return to its calling function before the task is finished if it is waiting for something. A non-block-

- 
- i. Be advised that FAT12 support will not be available in future Dynamic C versions. It is not recommended that you enable FAT12 support except to retrieve data before re-formatting partitions to FAT16. With FAT12 disabled, smaller partitions will be formatted as FAT16. With FAT12 enabled, small partitions formatted FAT16 are functional
  - ii. We use the terms *directory* and *subdirectory* somewhat interchangeably. The exception is the root directory—it is never called a subdirectory. Any directory below the root directory may be referred to as a directory or a subdirectory.

ing function can return a code that indicates it is not finished and should be called again. Used in conjunction with cooperative multitasking, non-blocking functions allow other processes to proceed while waiting for hardware resources to finish or become available.

A *driver* is the software interface that handles the hardware-specific aspects of any communication to or from the device.

## 12.1 Overview of FAT Documentation

A sample program is reviewed in [Section 12.2](#). Two additional sample programs, one for use with the blocking mode of the FAT and the other for use with the non-blocking mode are described in [Section 12.3](#). Then [Section 12.4](#) gives detailed descriptions of the various FAT file system functions (formatting, opening, reading, writing, and closing). Short, focused examples accompany each description. There is some general information about FAT file systems and also some web links for further study in [Section 12.5](#).

**NOTE:** All error codes returned from the Dynamic C FAT file system are defined in `\Lib\Rabbit4000\ERRNO.LIB`.

## 12.2 Running Your First FAT Sample Program

To run FAT samples, you need a Rabbit-based board with a supported flash type, such as the serial flash device available on the RCM4200 and 4210. FAT version 2.13 requires Dynamic C 10.21 or later and adds support for SD cards, which are available on the RCM4300 and 4310.

The board must be powered up and connected to a serial port on your PC through the programming cable to download a sample program.

In this section we look at `fat_create.c`, which demonstrate the basic use of the FAT file system. If you are using a serial or NAND flash device that has not been formatted or a removable device that was not formatted using Dynamic C, you must run `Samples\FileSystem\Fmt_Device.c` before you can run any other sample FAT program. The program, `Fmt_Device.c`, creates the default configuration of one partition that takes up the entire device.

If you are using an SD card, run `Fmt_Device.c` to remove the factory FAT32 partition and create a FAT16 partition. Be aware that although multiple partitions are possible on removable cards, most PC's will not support cards formatted in this fashion.

If you are using a removable NAND flash (XD cards), running `Fmt_Device.c` causes the device to no longer be usable without the Rabbit-based board or the Rabbit USB Reader for XD cards. Insert the NAND flash device into a USB-based flash card reader and format it to regain this usability. Note that this will only work if you have *not* defined the macro `NFLASH_CANERASEBADBLOCKS`. Defining this macro in a running application destroys proprietary information on the first block of the device, making it difficult to regain the usability of the NAND device when used without the Rabbit-based board.

If you are using FAT version 2.01 or later, you do not have to run `Fmt_Device.c` if you initialize the FAT file system with a call to `fat_AutoMount()` instead of `fat_Init()`. The function `fat_AutoMount()` can optionally format the device if it is unformatted; however, `fat_AutoMount()` will not erase and overwrite a factory-formatted removable device such as an SD card. If you are using an SD card, run `Fmt_Device.c` or erase the first three pages with the appropriate flash utility (`sdflash_inspect.c` or `nflash_inspect.c`).

After the device has been formatted, open `Samples\FileSystem\fat_create.c`. Compile and run the program by pressing function key F9.

In a nutshell, `fat_create.c` initializes FAT, then creates a file, writes “Hello world!” to it, and then closes the file. The file is re-opened and the file is read, which displays “Hello world!” in the Dynamic C Stdio window. Understanding this sample will make writing your own FAT application easier.

The sample program has been broken into two functional parts for the purpose of discussion. The first part deals with getting the file system up and running. The second part is a description of writing and reading files.

## 12.2.1 Bringing Up the File System

We will look at the first part of the code as a whole, and then explain some of its details.

**File Name:** `Samples\FileSystem\fat_create.c`

```
#define FAT_BLOCK // use blocking mode
#include "fat.lib" // of FAT library

FATfile my_file; // get file handle
char buf[128]; // 128 byte buffer for read/write of file

int main(){
int i;
int rc; // Check return codes from FAT API
long prealloc; // Used if the file needs to be created.
fat_part *first_part; // Use the first mounted FAT partition.

rc = fat_AutoMount(FDDF_USE_DEFAULT);

first_part = NULL;
for(i=0;i < num_fat_devices * FAT_MAX_PARTITIONS; ++i)
{ // Find the first mounted partition
if ((first_part = fat_part_mounted[i]) != NULL) {
break; // Found mounted partition, so use it
}
}

if (first_part == NULL) { // Check if mounted partition was found
rc = (rc < 0) ? rc : -ENOPART; // None found, set rc to a FAT error code
} else{
printf("fat_AutoMount() succeeded with return code %d.\n", rc);
rc = 0; // Found partition; ignore error, if any
}

if (rc < 0){ // negative values indicate error
if (rc == -EUNFORMAT)
printf("Device not Formatted, Please run Fmt_Device.c\n");
else
printf("fat_AutoMount() failed with return code %d.\n", rc);
exit(1);
} // OK, file system exists and is ready to access. Let's create a file.
```

The first two statements:

```
#define FAT_BLOCK
#use "fat.lib"
```

cause the FAT library to be used in blocking mode.

The configuration library `fat.lib` chooses initialization settings based on the board type. The statement `#use "fat.lib"` brings in this configuration library, which in turn brings in the appropriate device driver library. The following table lists the device drivers that are available in the different FAT versions.

**Table 1.**

| FAT Version | Available Device Drivers                                                              |
|-------------|---------------------------------------------------------------------------------------|
| 2.12        | <code>sflash_fat.lib</code><br><code>nflash_fat.lib</code>                            |
| 2.13        | <code>sflash_fat.lib</code><br><code>nflash_fat.lib</code><br><code>SD_fat.lib</code> |

Defining the macro `_DRIVER_CUSTOM` notifies `fat_config.lib` that a custom driver or hardware configuration is being used. For more information on how this works, see [Section 12.5](#)

Next some static variables are declared: a file structure to be used as a handle to the file that will be created and a buffer that will be used for reading and writing the file.

Now we are in `main()`. First there are some variable declarations: the integer `rc` is for the code returned by the FAT API functions. This code should always be checked, and *must* be checked if the non-blocking mode of the FAT is used. The descriptions for each function list possible return codes.

The variable `prealloc` stores the number of bytes to reserve on the device for use by a specific file. These clusters are attached to the file and are not available for use by any other files. This has some advantages and disadvantages. The obvious disadvantage is that it uses up space on the device. Some advantages are that having space reserved means that a log file, for instance, could have a portion of the drive set aside for its use only. Another advantage is that if you are transferring a known amount of information to a file, pre-allocation not only sets aside the space so you know you will not get half way through and run out, but it also makes the writing process a little faster as the allocation of clusters has already been dealt with so there is no need to spend time getting another cluster.

This feature should be used with care as pre-allocated clusters do not show up on directory listings until data is actually written to them, even though they have locked up space on the device. The only way to get unused pre-allocated clusters back is to delete the file to which they are attached, or use the `fat_truncate()` or `fat_split()` functions to trim or split the file. In the case of `fat_split()`, the pre-allocated space is not freed, but rather attached to the new file created in the split.

Lastly, a pointer to a partition structure is declared with the statement:

```
fat_part *first_part;
```

This pointer will be used as a handle to an active partition. (The `fat_part` structure and other data structures needed by the FAT file system are discussed in `fat_AutoMount()`.) The partition pointer will be passed to API functions, such as `fat_open()`.

Now a call is made to `fat_AutoMount()`. This function was introduced in FAT version 2.01 as a replacement for `fat_Init()`. Whereas `fat_Init()` can do all the things necessary to ready the first partition on the first device for use, it is limited to that. The function `fat_AutoMount()` is more flexible because it uses data from the configuration file `fat_config.lib` to identify FAT partitions and to optionally ready them for use, depending on the flags parameter that is passed to it. The flags parameter is described in the function description for `fat_AutoMount()`.

For this sample program, we are interested in the first usable FAT partition. The `for` loop after the call to `fat_AutoMount()` finds the partition, if one is available.

The `for` loop allows us to check every possible partition by using `num_fat_devices`, which is the number of configured devices, and then multiplying the configured devices by the maximum number of allowable partitions on a device, which is four. The `for` loop also makes use of `fat_part_mounted`, an array of pointers to partition structures that is populated by the `fat_autoMount()` call.

## 12.2.2 Using the File System

The rest of `fat_create.c` demonstrates how to use the file system once it is up and running.

**File Name:** `Samples\FileSystem\fat_create.c`

```
prealloc = 0;
rc = fat_Open(first_part, "HELLO.TXT", FAT_FILE, FAT_CREATE,
&my_file, &prealloc);
if (rc < 0) {
printf("fat_Open() failed with return code %d\n", rc);
exit(1);
}
rc = fat_Write(&my_file, "Hello, world!\r\n", 15);
if (rc < 0) {
printf("fat_Write() failed with return code %d\n", rc);
exit(1);
}
rc = fat_Close(&my_file);
if (rc < 0) {
printf("fat_Close() failed with return code %d\n", rc);
}
rc = fat_Open(first_part, "HELLO.TXT",FAT_FILE, 0, &my_file, NULL);
if (rc < 0) {
printf("fat_Open() (for read) failed, return code %d\n", rc);
exit(1);
}
rc = fat_Read(&my_file, buf, sizeof(buf));
if (rc < 0) {
printf("fat_Read() failed with return code %d\n", rc);
}
else {
printf("Read %d bytes:\n", rc);
printf("%*.*s", rc, rc, buf); // Print a string which is not NULL terminated
printf("\n");
}
fat_UnmountDevice(first_part->dev);
printf("All OK.\n");
return 0;
}
```

The call to `fat_Open()` creates a file in the root directory and names it `HELLO.TXT`. A file must be opened before you can write or read it.

```
rc = fat_Open(first_part, "HELLO.TXT", FAT_FILE, FAT_CREATE, &my_file,
 &prealloc);
```

The parameters are as follows:

- `first_part` points to the partition structure initialized by `fat_AutoMount()`.
- `"HELLO.TXT"` is the file name, and is always an absolute path name relative to the root directory. All paths in Dynamic C must specify the full directory path explicitly.
- `FAT_FILE` identifies the type of object, in this case a file. Use `FAT_DIR` to open a directory.
- `FAT_CREATE` creates the file if it does not exist. If the file does exist, it will be opened, and the position pointer will be set to the start of the file. If you write to the file without moving the position pointer, you will overwrite existing data.

Use `FAT_OPEN` instead of `FAT_CREATE` if the file or directory should already exist. If the file does not exist, you will get an `-ENOENT` error.

Use `FAT_MUST_CREATE` if you know the file does not exist. This is a fail-safe way to avoid opening and overwriting an existing file since an `-EEXIST` error is returned if you attempt to create a file that already exists.

- `&my_file` is a file handle that points to an available file structure. It will be used for this file until the file is closed.
- `&prealloc` points to the number of bytes to allocate for the file. You do not want to pre-allocate any more than the minimum number of bytes necessary for storage, and so `prealloc` was set to 0. You could also use `NULL` instead of `prealloc` and `prealloc = 0`.

Next, the sample program writes the data `"Hello, world!\r\n"` to the file.

```
fat_Write(&my_file, "Hello, world!\r\n", 15);
```

The parameters are as follows:

- `&my_file` is a pointer to the file handle opened by `fat_Open()`.
- `"Hello, world!\r\n"` is the data written to the file. Note that `\r\n` (carriage return, line feed) appears at the end of the string in the call. This is essentially a FAT (or really, DOS) convention for text files. It is good practice to use the standard line-end conventions. (If you just use `\n`, the file will read just fine on Unix systems, but some DOS-based programs may have difficulties.)
- 15 is the number of characters to write. Be sure to select this number with care since a value that is too small will result in your data being truncated, and a value that is too large will append any data that already exists beyond your new data.

The file is closed to release the file handle to allow it to be used to identify a different file.

```
rc = fat_Close(&my_file);
```

The parameter `&my_file` is a handle to the file to be closed. Remember to check for any return code from `fat_Close()` since an error return code may indicate the loss of data.

The file must be opened for any further work, even though `&my_file` may still reference the desired file. The file must be open to be active, so we call `fat_Open()` again. Now the file can be read.

```
rc = fat_Read(&my_file, buf, sizeof(buf));
```

The function `fat_Read()` returns the number of characters actually read. The parameters are as follows:

- `&my_file` is a handle to the file to be read.
- `buf` is a buffer for reading/writing the file that was defined at the beginning of the program.
- `sizeof(buf)` is the number of bytes to be read into `buf`. It does not have to be the full size of the buffer

Characters are read beginning at the current position of the file. (The file position can be changed with the `fat_Seek()` function.) If the file contains fewer than `sizeof(buf)` characters from the current position to the end-of-file marker (EOF), the transfer will stop at the EOF. If the file position is already at EOF, 0 is returned. The maximum number of characters read is 32767 bytes per call.

The file can now be closed. Call `fat_UnmountDevice()`<sup>i</sup> rather than simply calling `fat_Close()` to ensure that any data stored in cache will be written to the device. With a write-back cache, writes are delayed until either:

- all cache buffers are full and a new FAT read request requires a “dirty” cache buffer to be written out before the read can take place, or
- cache buffers for a partition or a device are being flushed due to an unmount call or explicit flush call.

Calling `fat_UnmountDevice()` will close all open files and unmount all mounted FAT partitions. This is the safest way to shut down a device. The parameter `first_part->dev` is a handle to the device to be unmounted.

```
fat_UnmountDevice(first_part->dev);
```

**NOTE:** A removable device must be unmounted in order to flush its data before removal. Failure to unmount any partition on a device that has been written to could corrupt the file system.

---

i. Call `fat_UnmountPartition()` when using a FAT version prior to v2.06.

## 12.3 More Sample Programs

This section studies blocking sample `FAT_SHELL.C` and non-blocking sample `FAT_NB_Costate.c`. More sample programs are in the Dynamic C folder `Samples\FileSystem\FAT`. For example, there is `udppages.c`, an application that shows how to combine HTTP, FTP and zserver functionality to create web content than can be updated via FTP.

As described in [Section 12.2](#), you will need a target board or core module with a supported flash device, powered up and connected to a serial port on your PC through the programming cable.

### 12.3.1 Blocking Sample

The sample program `Samples\FileSystem\FAT_SHELL.C` allows you to use the FAT library by entering DOS-like or Unix-like commands. To run this sample, open Dynamic C, then open `FAT_SHELL.C`. Compile and run `FAT_SHELL.C` by pressing F9. If the flash device has not been formatted and partitioned, `FAT_SHELL.C` will format and partition the flash device, and then you will be prompted to run `FAT_SHELL.C` again (just press F9 when prompted). A display similar to the one shown in [Figure 1](#) will open in the Dynamic C Stdio window.

Optional parameters are denoted by the square braces [ and ] following the command name. The [alc] after “touch” and “mtouch” indicates an optional allocation amount in bytes. The square braces in the description indicate the default value that will be used if the optional parameter is not given.

Figure 1. List of Shell Commands

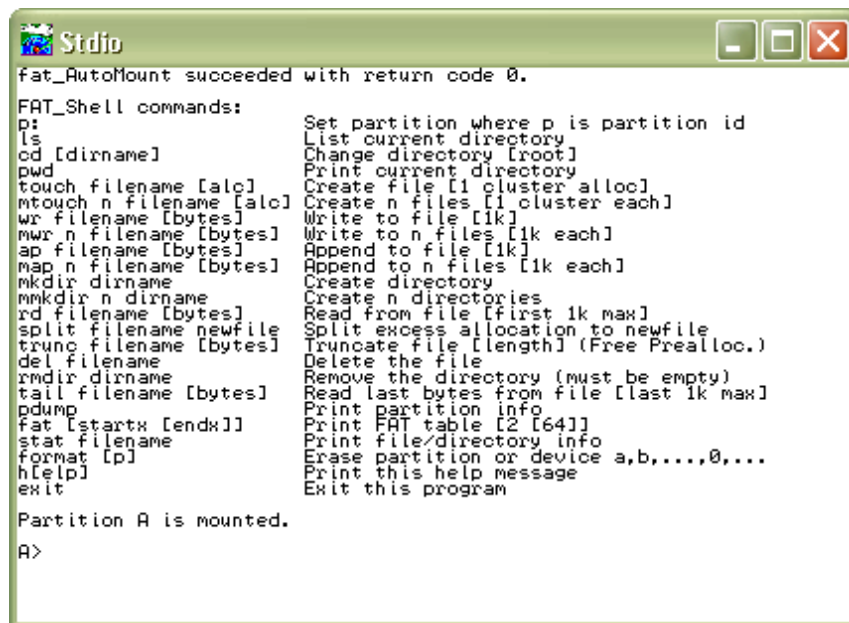

```
fat_AutoMount succeeded with return code 0.
FAT_Shell commands:
p: Set partition where p is partition id
ls List current directory
cd [dirname] Change directory [root]
pwd Print current directory
touch filename [alc] Create file [1 cluster alloc]
mtouch n filename [alc] Create n files [1 cluster each]
wr filename [bytes] Write to file [1k]
mwr n filename [bytes] Write to n files [1k each]
ap filename [bytes] Append to file [1k]
map n filename [bytes] Append to n files [1k each]
mkdir dirname Create directory
mmkdir n dirname Create n directories
rd filename [bytes] Read from file [first 1k max]
split filename newfile Split excess allocation to newfile
trunc filename [bytes] Truncate file [length] (Free Prealloc.)
del filename Delete the file
rmdir dirname Remove the directory (must be empty)
tail filename [bytes] Read last bytes from file [last 1k max]
pdump Print partition info
fat [startx [endx]] Print FAT table [2 [64]]
stat filename Print file/directory info
format [p] Erase partition or device a,b,...,0,...
help Print this help message
exit Exit this program

Partition A is mounted.
A>
```

You can type “h” and press enter at any time to display the FAT shell commands.

In the following examples the commands that you enter are shown in boldface type. The response from the shell program is shown in regular typeface.

```
> ls
Listing '' (dir length 16384)
 hello.txt rhsvdA len=15 clust=2
>
```

This shows the HELLO.TXT file that was created using the FAT\_CREATE.C sample program. The file length is 15 bytes. Cluster 2 has been allocated for this file. The “ls” command will display up to the first six clusters allocated to a file.

The flag, rhsvdA, displays the file or directory attributes, with upper case indicating that the attribute is turned on and lower case indicating that the attribute is turned off. In this example, the archive bit is turned on and all other attributes are turned off.

These are the six attributes:

|                        |                         |
|------------------------|-------------------------|
| <b>r</b> - read-only   | <b>v</b> - volume label |
| <b>h</b> - hidden file | <b>d</b> - directory    |
| <b>s</b> - system      | <b>a</b> - archive      |

To create a directory named DIR1, do the following:

```
> mkdir dir1
Directory '/dir1' created with 1024 bytes
>
```

This shows that DIR1 was created, and is 1024 bytes (size may vary by flash type).

Now, select DIR1:

```
> cd dir1
PWD = '/dir1'
>
```

Add a new file called RABBIT.TXT:

```
> touch rabbit.txt
File '/dir1/rabbit.txt' created with 1024 bytes
>
```

Note that the file name was appended to the current directory. Now we can write to RABBIT.TXT. The shell program has predetermined characters to write, and does not allow you to enter your own data.

```
> wr rabbit.txt
File '/dir1/rabbit.txt' written with 1024 bytes out of 1024
>
```

To see what was written, use the “rd” command.

```
> rd rabbit.txt
rabbit.txt 1024 The quick brown fox jumps over the lazy dog
rabbit.txt 1024 The quick brown fox jumps over the lazy dog
.
.
rab

Read 1024 bytes out of 1024
>
```

### 12.3.2 Non-Blocking Sample

To use the FAT file system in non-blocking mode, do not include the statement `#define FAT_BLOCK` in your application. The program interface to the library is the same as the blocking version, with the exception of the return code `-EBUSY` from many of the API functions.

The sample program `Fat_NB_Costate.c` in the `Samples\FileSystem` folder is an example of a non-blocking application. To view the code in its entirety, open it in Dynamic C. The following discussion will not examine every line of code, but will focus on what shows the non-blocking nature of the FAT library and how the application takes advantage of it.

Run `Fat_NB_Costate.c` and after 10 seconds the Stdio window will show something similar to the following:

Figure 2. Screen Shot of `Fat_NB_Costate.c` Running

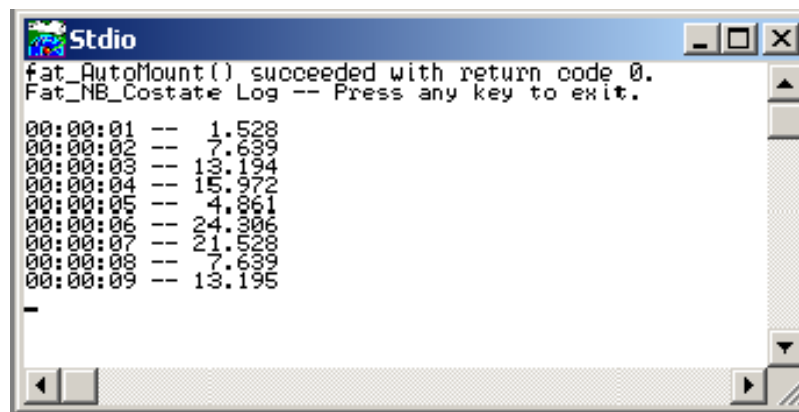

```
Stdio
fat_AutoMount() succeeded with return code 0.
Fat_NB_Costate Log -- Press any key to exit.
00:00:01 -- 1.528
00:00:02 -- 7.639
00:00:03 -- 13.194
00:00:04 -- 15.972
00:00:05 -- 24.061
00:00:06 -- 24.306
00:00:07 -- 21.528
00:00:08 -- 7.639
00:00:09 -- 13.195
-
```

Each line is an entry into a file that is stored in the FAT file system. The file is appended once every second and read and displayed once every ten seconds. In addition to the file system use and the screen output, if you are using an RCM3300, RCM3700 or PowerCore FLEX development board, the application blinks the LED on your board.

The code preceding `main()` brings in the required library and declares the file structure. And, as expected, there is no `#define` for the macro `FAT_BLOCK`. At the start of `main()` some system variables are created and initialized. This is followed by the code to bring up the FAT file system, which is similar to what we examined in [Section 12.2.1](#) when looking at `fat_create.c`, with two essential differences. One, since we have initialized the FAT to be in non-blocking and we are making some calls to FAT functions that must return before we can continue, we must wait for the return.

A `while` loop accomplishes our goal of blocking on the function call until it returns something other than `busy`.

```
while ((rc = fat_Open(first_part, name, FAT_FILE, FAT_MUST_CREATE,
 &file, &alloc)) == -EBUSY);
```

The second difference from our earlier sample is the statement right before `fat_Open()`:

```
file.state = 0;
```

This is required before opening a file when using non-blocking mode in order to indicate that the file is not in use. Only do this once. After you have opened the file, do not alter the contents of the file structure.

If `fat_Open()` succeeds we can go into the non-blocking section of the program: three costatements inside an endless `while` loop. The benefit of using the non-blocking mode of the FAT file system is realized when using costatements, an extension of Dynamic C that implements cooperative multitasking. Instead of waiting while a function finishes its execution, the application can accomplish other tasks.

### 12.3.2.1 Costatement that Writes a File

The first costate is named `putdata`. It waits for one second and then creates a string to timestamp the entry of a randomly generated number that is then appended to a file.

```
while (1){
 costate putdata always_on
 {
 waitfor (DelaySec(1)); // Wait for one second to elapse
```

Note that the `always_on` keyword is used. This is required when using a named costatement to force it to execute every time it is encountered in the execution thread (unless it is made inactive by a call to `CoPause()`).

It is easy to suspend execution within a costate by using the `waitfor` keyword. The costate will relinquish control if the argument to `waitfor` (in this case a call to `DelaySec()`) evaluates to `FALSE`. The next time the execution thread reaches `putdata`, `waitfor` will be called again. This will go on until `DelaySec()` returns `TRUE`, i.e., when one second has elapsed from the time `DelaySec()` was first called from within `waitfor`.

After the one second delay, the string to write to the file is placed in a buffer and a looping variable and position pointer are initialized.

```
sprintf(obuf, "%02d:%02d:%02d -- %6.3f \n", h, m, s, (25.0 * rand()));
ocount = 0;
optr = obuf;
```

Before the buffer contents can be written to a file in the FAT file system, we must ensure that no collisions occur since there is another `costate` that will attempt to read the file every ten seconds. A file can not be read from and written to at the same time. In the following code the `waitfor` keyword is used with the global variable `filestate` (defined at the top of the application) to implement a locking mechanism. As soon as the file becomes available for `putdata`, it is marked unavailable for `showdata`.

```

waitfor (filestate == 0); // Wait until file is available
filestate = 1; // Show file is being updated

```

The next block of code appends the latest entry into the file that was opened at the start of the application.

```

while (ocount < REC_LEN){ // Loop until entire record is written
 waitfor((rc = fat_Write(&file, optr, REC_LEN - ocount)) != -EBUSY);
 if (rc < 0){
 printf("fat_Write: rc = %d\n",rc);
 while ((rc = fat_UnmountDevice(first_part->dev)) == -EBUSY);
 return rc;
 }
 optr += rc; // Move output pointer
 ocount += rc; // Add number of characters written
}
filestate = 0; // Show file is idle
}

```

Again, `waitfor` is used to voluntarily relinquish control, this time while waiting for the write function to complete. If an error occurs during the write operation the device is unmounted and the application exits. Otherwise the loop counter and the buffer position pointer are advanced by the number of bytes actually written. Since this can be less than the requested number of bytes, it is best to check in a loop such as the `while` loop shown in `putdata`.

The last action taken by `putdata` is to reset `filestate`, indicating that the open file is available.

### 12.3.2.2 Costatement that Reads and Displays a File

The costatement named `showdata` waits for ten seconds. Then it waits for the open file to be available, and when it is, immediately marks it as unavailable.

```

costate showdata always_on{
 waitfor (DelaySec(10));
 waitfor (filestate == 0);
 filestate = 2;
}

```

The next statement modifies the internal file position pointer. The first time this costate runs, `readto` is zero, meaning the position pointer is at the first byte of the file. The variable `readto` is incremented every time a record is read from the file, allowing `showdata` to always know where to seek to next.

```

waitfor (fat_Seek(&file, readto, SEEK_SET) != -EBUSY);

```

The rest of `showdata` is a `while` loop inside of a `while` loop. The inner `while` loop is where each record is read from the file into the buffer and then displayed in the Stdio window with the `printf()` call. Since `fat_Read()` may return less than the requested number of bytes, the `while` loop is needed to make sure that the function will be called repeatedly until all bytes have been read. When the full record has been read, it will then be displayed to the Stdio window.

The outer while loop controls when to stop reading records from the file. After the last record is read, the `fat_Read()` function is called once more, returning an end-of-file error. This causes the `if` statements that are checking for this error to return `TRUE`, which resets `filestate` to zero, breaking out of the outer while loop and freeing the lock for the `putdata` costatement to use.

```
while (filestate){
 icount = 0;
 iptr = ibuf;
 while (icount < REC_LEN) {
 waitFor((rc = fat_Read(&file, iptr, REC_LEN-icount)) != -EBUSY);
 if (rc < 0)
 {
 if (rc == -EEOF)
 {
 filestate = 0;
 break;
 }
 printf("fat_Read: rc = %d\n",rc);
 while ((rc=fat_UnmountDevice(first_part->dev)) == -EBUSY);
 return rc;
 }
 iptr += rc;
 icount += rc;
 }
 // end of inner while loop
 if (filestate)
 {
 printf("%s", ibuf);
 readto += REC_LEN;
 }
}
// end of outer while loop
```

The other costatement in the endless while loop is the one that blinks the LED. It illustrates that while using the file system in non-blocking mode, there is still plenty of time for other tasks.

## 12.4 FAT Operations

### 12.4.1 Format and Partition the Device

The flash device must be formatted before its first use. Formatting it after its first use may destroy information previously placed on it.

#### 12.4.1.1 Default Partitioning

As a convenience, `Samples/FileSystem/Fmt_Device.c` is provided to format the flash device. This program can format individual FAT 12/16 partitions, or can format all FAT 12/16 partitions found on a device. If no FAT 12/16 partitions are found, it offers the option of erasing the entire device and formatting it with a single FAT 16 partition. Be aware that this will destroy any data on the device, including that contained on FAT 32 partitions. This is an easy way to format new media that may contain an empty FAT32 partition spanning the entire device, such as a new SD or XD card.

After the device has been formatted with `Fmt_Device.c`, an application that wants to use the FAT file system just has to call the function `fat_Init()` (replaced in FAT version 2.01) or `fat_AutoMount()`. If you are calling `fat_AutoMount()` refer to [Section 12.2.1](#) for an example of its use. Note that if you call `fat_AutoMount()` using the configuration flag `FDDF_DEV_FORMAT`, you may not need to run `Fmt_Device.c`.

#### 12.4.1.2 Creating Multiple Partitions

To create multiple partitions on the flash device use the sample program `FAT_Write_MBR.c`, which will allow you to easily create as many as four partitions. This program does require that the device be “erased” before being run. This can be done with the appropriate sample program: `sdfash_inspect.c`, `sflash_inspect.c` or `nflash_inspect.c`. You only need to clear the first three pages on SD cards or serial flash, or the first page on NAND flash or XD cards. Once this is done, run `FAT_Write_MBR` and it will display the total size of the device in MegaBytes and allow you to specify the size of each partition until all the space is used. If you specify an amount larger than the space remaining, then all remaining space will be used for that partition. Once all space is specified, it will ask approval to write the new partition structure. This utility does not format the partitions, it merely creates their definitions. Run `Fmt_device.c` afterwards and use the 0 or 1 option to format the full device and all partitions will be formatted. Be forewarned that on removable media, using multiple partitions will typically make the device unusable with PC readers.

The sample program `FAT_Write_MBR.c` is distributed with FAT version 2.13. It is also compatible with FAT versions 2.01, 2.05 and 2.10. If you have one of these earlier versions of the FAT and would like a copy of `FAT_Write_MBR.c`, please contact Technical Support either by email to [support@rabbitsemi-conductor.com](mailto:support@rabbitsemi-conductor.com) or by using the online form: [www.rabbit.com/support/questionSubmit.shtml](http://www.rabbit.com/support/questionSubmit.shtml).

There is a way to create multiple partitions without using the utility `FAT_Write_MBR.c`; this auxiliary method is explained in [Section 12.5.3.5](#).

### 12.4.1.3 Preserving Existing Partitions

If the flash device already has a valid partition that you want to keep, you must know where it is so you can fit the FAT partition onto the device. This requires searching the partition table for both available partitions and available space. An available partition has the `partsecsize` field of its `mbr_part` entry equal to zero.

Look in `lib/.../RCM3300/RemoteApplicationUpdate/downloadmanager.lib` for the function `dml_initserialflash()` for an example of searching through the partition table for available partitions and space. See the next section for more information on the download manager (DLM) and how to set up coexisting partitions.

### 12.4.1.4 FAT and DLM Partitions

The RabbitCore RCM3300 comes with a download manager utility that creates a partition on a serial flash device, which is then used by the utility to remotely update an application. You can set up a device to have both a DLM partition and a FAT partition.

Run the program `Samples/RCM3300/RemoteApplicationUpdate/DLM_FAT_FORMAT.C`. This program must be run on an unformatted serial flash, i.e., a flash with no MBR. To remove an existing MBR, first run the program `Samples/RCM3300/SerialFlash/SFLASH_INSPECT.C` to clear the first three pages.

The program `DLM_FAT_FORMAT.C` will set aside space for the DLM partition and use the rest of the device to create a FAT partition. Then, when you run the DLM software, it will be able to find space for its partition and will coexist with the FAT partition. This shows the advantage to partitions: Partitions set hard boundaries on the allocation of space on a device, thus neither FAT nor the DLM software can take space from the other.

## 12.4.2 File and Directory Operations

The Dynamic C FAT implementation supports the basic set of file and directory operations. Remember that a partition must be mounted before it can be used with any of the file, directory or status operations.

### 12.4.2.1 Open and Close Operations

The `fat_Open()` function opens a file or a directory. It can also be used to create a file or a directory. When using the non-blocking FAT, check the return code and call it again with the same arguments until it returns something other than `-EBUSY`.

```
rc = fat_Open(my_part, "DIR\\FILE.TXT", FAT_FILE, FAT_CREATE,
 &my_file, &prealloc);
```

The first parameter, `my_part`, points to a partition structure. This pointer must point to a mounted partition. Some of the sample programs, like `fat_create.c`, declare a local pointer and then search for a partition pointer in the global array `fat_part_mounted[]`. Other sample programs, like `fat_shell.c`, define an integer to be used as an index into `fat_part_mounted[]`. Both methods accomplish the same goal of gaining access to a partition pointer.

The second parameter contains the file name, including the directory (if applicable) relative to the root directory. All paths in Dynamic C must specify the full directory path explicitly, e.g., `DIR1\\FILE.EXT` or `DIR1/FILE.EXT`. The direction of the slash in the pathname is a backslash by default. If you use the default backslash for the path separator, you must always precede it with another backslash, as shown in the above call to `fat_Open()`. This is because the backslash is an escape character in a Dynamic C string. To use the forward slash as the path separator, define the macro `FAT_USE_FORWARDSLASH` in your application (or in `FAT.LIB` to make it the system default).

The third parameter determines whether a file or directory is opened (`FAT_FILE` or `FAT_DIR`).

The fourth parameter is a flag that limits `fat_Open()` to the action specified. `FAT_CREATE` creates the file (or directory) if it does not exist. If the file does exist, it will be opened, and the position pointer will be set to the start of the file. If you write to the file without moving the position pointer, you will overwrite existing data. Use `FAT_MUST_CREATE` if you know the file does not exist; this last option is also a fail-safe way to avoid opening and overwriting an existing file since an `-EEXIST` error message will be returned if you attempt to create a file that already exists.

The fifth parameter, `&my_file`, is an available file handle. After a file or directory is opened, its handle is used to identify it when using other API functions, so be wary of using local variables as your file handle.

The final parameter is an initial byte count if the object needs to be created. It is only used if the `FAT_CREATE` or `FAT_MUST_CREATE` flag is used and the file or directory does not already exist. The byte count is rounded up to the nearest whole number of clusters greater than or equal to 1. On return, the variable `prealloc` is updated to the number of bytes allocated. Pre-allocation is used to set aside space for a file, or to speed up writing a large amount of data as the space allocation is handled once.

Pass `NULL` as the final parameter to indicate that you are opening the file for reading or that a minimum number of bytes needs to be allocated to the file at this time. If the file does not exist and you pass `NULL`, the file will be created with the minimum one cluster allocation.

Once you are finished with the file, you must close it to release its handle so that it can be reused the next time a file is created or opened.

```
rc = fat_Close(&my_file);
```

Remember to check the return code from `fat_Close()` since an error return code may indicate the loss of data. Once you are completely finished, call `fat_UnmountDevice()` to make sure any data stored in the cache is written to the flash device.

### 12.4.2.2 Read and Write Operations

Use `fat_Read()` to read a file.

```
rc = fat_Read(&my_file, buf, sizeof(buf));
```

The first parameter, `&my_file`, is a pointer to the file handle already opened by `fat_Open()`. The parameter `buf` points to a buffer for reading the file. The `sizeof(buf)` parameter is the number of bytes to be read into the buffer. It does not have to be the full size of the buffer. If the file contains fewer than `sizeof(buf)` characters from the current position to the end-of-file marker (EOF), the transfer will stop at the EOF. If the file position is already at the EOF, 0 is returned. The maximum number of characters read is 32767 bytes per call.

The function returns the number of characters read or an error code. Characters are read beginning at the current position of the file. If you have just written to the file that is being read, the file position pointer will be where the write left off. If this is the end of the file and you want to read from the beginning of the file you must change the file position pointer. This can be done by closing the file and reopening it, thus moving the position pointer to the start of the file. Another way to change the position pointer is to use the `fat_Seek()` function. This function is explained in [Section 12.4.2.3](#).

Use `fat_ReadDir()` to read a directory. This function is explained in [Section 12.4.2.5](#).

Use `fat_Write()` or `fat_xWrite()` to write to a file. The difference between the two functions is that `fat_xWrite()` copies characters from a string stored in extended memory.

```
rc = fat_Write(&my_file, "Write data\r\n", 12);
```

The first parameter, `&my_file`, is a pointer to the file handle already opened by `fat_Open()`. Because `fat_Open()` sets the position pointer to the start of the file, you will overwrite any data already in the file. You will need to call `fat_Seek()` if you want to start the write at a position other than the start of the file (see [Section 12.4.2.3](#)).

The second parameter contains the data to write to the file. Note that `\r\n` (carriage return, line feed) appear at the end of the string in the function. This is essentially a FAT (or really, DOS) convention for text files. It is good practice to use these standard line-end conventions. (If you only use `\n`, the file will read just fine on Unix systems, but some DOS-based programs may have difficulties.) The third parameter specifies the number of characters to write. Select this number with care since a value that is too small will result in your data being truncated, and a value that is too large will append any data that already exists beyond your new data.

Remember that once you are finished with a file you must close it to release its handle. You can call the `fat_Close()` function, or, if you are finished using the file system on a particular partition, call `fat_UnmountPartition()`, which will close any open files and then unmount the partition. If you are finished using the device, it is best to call `fat_UnmountDevice()`, which will close any open FAT files on the device and unmount all mounted FAT partitions. Unmounting the device is the safest method for shutting down after using the device.

### 12.4.2.3 Going to a Specified Position in a File

The position pointer is at the start of the file when it is first opened. Two API functions, `fat_Tell()` and `fat_Seek()`, are available to help you with the position pointer.

```
fat_Tell(&my_file, &pos);
fat_Seek(&my_file, pos, SEEK_SET);
```

The `fat_Tell()` function does not change the position pointer, but reads its value (which is the number of bytes from the beginning of the file) into the variable pointed to by `&pos`. Zero indicates that the position pointer is at the start of the file. The first parameter, `&my_file`, is the file handle already opened by `fat_Open()`.

The `fat_Seek()` function changes the position pointer. Clusters are allocated to the file if necessary, but the position pointer will not go beyond the original end of file (EOF) unless doing a `SEEK_RAW`. In all other cases, extending the pointer past the original EOF will preallocate the space that would be needed to position the pointer as requested, but the pointer will be left at the original EOF and the file length will not be changed. If this occurs, the error code `-EEOF` is returned to indicate the space was allocated but the pointer was left at the EOF. If the position requires allocating more space than is available on the device, the error code `-ENOSPC` is returned.

The first parameter passed to `fat_Seek()` is the file handle that was passed to `fat_Open()`. The second parameter, `pos`, is a long integer that may be positive or negative. It is interpreted according to the value of the third parameter. The third parameter must be one of the following:

- `SEEK_SET` - `pos` is the byte position to seek, where 0 is the first byte of the file. If `pos` is less than 0, the position pointer is set to 0 and no error code is returned. If `pos` is greater than the length of the file, the position pointer is set to EOF and error code `-EEOF` is returned.
- `SEEK_CUR` - seek `pos` bytes from the current position. If `pos` is less than 0 the seek is towards the start of the file. If this goes past the start of the file, the position pointer is set to 0 and no error code is returned. If `pos` is greater than 0 the seek is towards EOF. If this goes past EOF the position pointer is set to EOF and error code `-EEOF` is returned.
- `SEEK_END` - seek to `pos` bytes from the end of the file. That is, for a file that is `x` bytes long, the statement:

```
fat_Seek (&my_file, -1, SEEK_END);
```

will cause the position pointer to be set at `x-1` no matter its value prior to the seek call. If the value of `pos` would move the position pointer past the start of the file, the position pointer is set to 0 (the start of the file) and no error code is returned. If `pos` is greater than or equal to 0, the position pointer is set to EOF and error code `-EEOF` is returned.

- `SEEK_RAW` - is similar to `SEEK_SET`, but if `pos` goes beyond EOF, using `SEEK_RAW` will set the file length and the position pointer to `pos`. This adds whatever data exists on the allocated space onto the end of the file..

#### 12.4.2.4 Creating Files and Subdirectories

While the `fat_Open()` function is versatile enough to not only open a file but also create a file or a subdirectory, there are API functions specific to the tasks of creating files and subdirectories.

The `fat_CreateDir()` function is used to create a subdirectory one level at a time.

```
rc = fat_CreateDir(my_part, "DIR1");
```

The first parameter, `my_part`, points to a partition structure. This pointer must point to a mounted partition. Some of the sample programs, like `fat_create.c`, declare a local pointer and then search for a partition pointer in the global array `fat_part_mounted[]`. Other sample programs, like `fat_shell.c`, define an integer to be used as an index into `fat_part_mounted[]`. Both methods accomplish the same goal of gaining access to a partition pointer.

The second parameter contains the directory or subdirectory name relative to the root directory. If you are creating a subdirectory, the parent directory must already exist.

Once `DIR1` is created as the parent directory, a subdirectory may be created, and so on.

```
rc = fat_CreateDir(my_part, "DIR1/SUBDIR");
```

Note that a forward slash is used in the pathname instead of a backslash. Either convention may be used. The backslash is used by default. To use a forward slash instead, define `FAT_USE_FORWARDSLASH` in your application or in `FAT.LIB`.

A file can be created using the `fat_CreateFile()` function. All directories in the path must already exist.

```
rc = fat_CreateFile(my_part, "DIR1/SUBDIR/FILE.TXT", &prealloc,
&my_file);
```

The first parameter, `my_part`, points to the static partition structure set up by `fat_AutoMount()`.

The second parameter contains the file name, including the directories (if applicable) relative to the root directory. All paths in the FAT library are specified relative to the root directory.

The third parameter indicates the initial number of bytes to pre-allocate. At least one cluster will be allocated. If there is not enough space beyond the first cluster for the requested allocation amount, the file will be allocated with whatever space is available on the partition, but no error code will be returned. If no clusters can be allocated, the `-ENOSPC` error code will return. Use `NULL` to indicate that no bytes need to be allocated for the file at this time. Remember that pre-allocating more than the minimum number of bytes necessary for storage will reduce the available space on the device.

The final parameter, `&my_file`, is a file handle that points to an available file structure. If `NULL` is entered, the file will be closed after it is created.

### 12.4.2.5 Reading Directories

The `fat_ReadDir()` function reads the next directory entry from the specified directory. A directory entry can be a file, directory or a label. A directory is treated just like a file.

```
fat_ReadDir(&dir, &dirent, mode);
```

The first parameter specifies the directory; `&dir` is an open file handle. A directory is opened by a call to `fat_OpenDir()` or by passing `FAT_DIR` in a call to `fat_Open()`. The second parameter, `&dirent`, is a pointer to a directory entry structure to fill in. The directory entry structure must be declared in your application, for example:

```
fat_dirent dirent;
```

#### Search Conditions

The last parameter, `mode`, determines which directory entry is being requested, a choice that is built from a combination of the macros described below. To understand the possible values for `mode`, the first thing to know is that a directory entry can be in one of three states: empty, active or deleted. This means you must choose one of the default flags described below, or one or more of the following macros:

- `FAT_INC_ACTIVE` - include active entries. This is the default setting if other `FAT_INC_*` macros are not specified; i.e., active files are included unless `FAT_INC_DELETED`, `FAT_INC_EMPTY`, or `FAT_INC_LNAME` is set.
- `FAT_INC_DELETED` - include deleted entries
- `FAT_INC_EMPTY` - include empty entries
- `FAT_INC_LNAME` - include long name entries (this is included for completeness, but is not used since long file names are not supported)

The above macros narrow the search to only those directory entries in the requested state. The search is then refined further by identifying particular attributes of the requested entry. This is done by choosing one or more of the following macros:

- `FATATTR_READ_ONLY` - include read-only entries
- `FATATTR_HIDDEN` - include hidden entries
- `FATATTR_SYSTEM` - include system entries
- `FATATTR_VOLUME_ID` - include label entries
- `FATATTR_DIRECTORY` - include directory entries
- `FATATTR_ARCHIVE` - include modified entries

Including a `FATATTR_*` macro means you do not care whether the corresponding attribute is turned on or off. Not including a `FATATTR_*` macro means you only want an entry with that particular attribute turned off. Note that the FAT system sets the archive bit on all new files as well as those written to, so including `FATATTR_ARCHIVE` in your mode setting is a good idea.

For example, if `mode` is `(FAT_INC_ACTIVE)` then the next directory entry that has all of its attributes turned off will be selected; i.e., an entry that is not read only, not hidden, not a system file, not a directory or a label, and not archived. In other words, the next writable file that is not hidden, system or already archived is selected.

But, if you want the next active file and do not care about the file's other attributes, mode should be (FAT\_INC\_ACTIVE | FATATTR\_READ\_ONLY | FATATTR\_HIDDEN | FATATTR\_SYSTEM | FATATTR\_ARCHIVE). This search would only exclude directory and label entries.

Now suppose you want only the next active read-only file, leaving out hidden or system files. The next group of macros allows this search by filtering on whether the requested attribute is set. The filter macros are:

- FAT\_FIL\_RD\_ONLY - filter on read-only attribute
- FAT\_FIL\_HIDDEN - filter on hidden attribute
- FAT\_FIL\_SYSTEM - filter on system attribute
- FAT\_FIL\_LABEL - filter on label attribute
- FAT\_FIL\_DIR - filter on directory attribute
- FAT\_FIL\_ARCHIVE - filter on modified attribute

If you set mode to (FAT\_INC\_ACTIVE | FATATTR\_READ\_ONLY | FAT\_FIL\_RD\_ONLY | FATATTR\_ARCHIVE), the result will be the next active file that has its read-only attribute set (and has the archive attribute in either state).

**NOTE:** If you have FAT version 2.05 or earlier, you do not have access to the FAT\_FIL\_\* macros.

## Default Search Flags

To make things easier, there are two predefined mode flags. Each one may be used alone or in combination with the macros already described.

- FAT\_INC\_ALL - selects any directory entry of any type.
- FAT\_INC\_DEF - selects the next active file or directory entry, including read-only or archived files. No hidden, system, label, deleted, or empty directories or files will be selected. This is typically what you see when you do a directory listing on your PC.

## Search Flag Examples

Here are some more examples of how the flags work.

1. If you want the next hidden file or directory:

Start with the FAT\_INC\_DEF macro default flag. This flag does not allow hidden files, so we need FATATTR\_HIDDEN. Then to narrow the search to consider only a hidden file or directory, we need the macro FAT\_FIL\_HIDDEN to filter on files or directories that have the hidden attribute set. That is, mode is set to:

```
FAT_INC_DEF | FATATTR_HIDDEN | FAT_FIL_HIDDEN
```

2. If you want the next hidden directory:

Start with the FAT\_INC\_DEF macro default flag. To narrow the search to directories only, we want entries with their directory attribute set; therefore, OR the macros FATATTR\_DIRECTORY and FAT\_FIL\_DIR. Then OR the macros FATATTR\_HIDDEN and FAT\_FIL\_HIDDEN to search only for directories with their hidden attribute set. Set mode to:

```
FAT_INC_DEF | FATATTR_DIRECTORY | FAT_FIL_DIR | FATATTR_HIDDEN |
FAT_FIL_HIDDEN
```

3. If you want the next hidden file (no directories):

Start with the predefined flag, `FAT_INC_DEF`. This flag allows directories, which we do not want, so we do an AND NOT of the `FATATTR_DIRECTORY` macro.

Next we want to narrow the search to only entries that have their hidden attribute set. The default flag does not allow hidden flags, so we need to OR the macros `FATTR_HIDDEN` and `FAT_FIL_HIDDEN`.

That is, set mode to:

```
FAT_INC_DEF & ~FATATTR_DIRECTORY | FATTR_HIDDEN |
FAT_FIL_HIDDEN
```

4. If you want the next non-hidden file (no directories):

First, select the `FAT_INC_DEF` filter default flag. This flag allows directories, which we do not want, so we do an AND NOT of the `FATATTR_DIRECTORY` macro. The default flag already does not allow hidden files, so we are done. That is, set mode to:

```
FAT_INC_DEF & ~FATATTR_DIRECTORY
```

5. Finally let's see how to get the next non-empty entry of any type.

Start with the predefined flag, `FAT_INC_ALL`. This flag selects any directory entry of any type. Since we do not want empty entries, we have to remove that search condition from the flag, so we do an AND NOT for the `FAT_INC_EMPTY` macro to filter out the empty entries. That means mode is the bitwise combination of the macros:

```
mode = FAT_INC_ALL & ~FAT_INC_EMPTY
```

#### 12.4.2.6 Deleting Files and Directories

The `fat_Delete()` function is used to delete a file or directory. The second parameter sets whether a file or directory is being deleted. Only one file or directory may be deleted at any one time—this means that you must call `fat_Delete()` at least twice to delete a file and its associated directory (if the directory has no other files or subdirectories since a directory must be empty to be deleted).

```
fat_Delete(my_part, FAT_FILE, "DIR/FILE.TXT");
```

The first parameter, `my_part`, points to the static partition structure that was populated by `fat_AutoMount()`. The second parameter is the file type, `FAT_FILE` or `FAT_DIR`, depending on whether a file or a directory is to be deleted. The third parameter contains the file name, including the directory (if applicable) relative to the directory root. All paths in the FAT library are specified relative to the root directory.

## Error Handling

Most routines in the FAT library return an int value error code indicating the status of the requested operation. [Table 2](#) contains a list of error codes specific to the FAT file system. These codes, along with other error codes an application may encounter, are defined in `\Lib\Rabbit4000\ERRNO.LIB`.

**Table 2. FAT-Specific Error Codes**

| Code          | Value | Description                                                                                                                                                                                                                                                                                                                   |
|---------------|-------|-------------------------------------------------------------------------------------------------------------------------------------------------------------------------------------------------------------------------------------------------------------------------------------------------------------------------------|
| EFATMUTEX     | 300   | FAT Mutex error (uC/OS).                                                                                                                                                                                                                                                                                                      |
| EROOTFULL     | 301   | Root directory full.                                                                                                                                                                                                                                                                                                          |
| ENOPART       | 302   | Not partitioned.                                                                                                                                                                                                                                                                                                              |
| EBADPART      | 303   | Partition bad or unrecognized.                                                                                                                                                                                                                                                                                                |
| EUNFORMAT     | 304   | Partition or volume not formatted.                                                                                                                                                                                                                                                                                            |
| ETYPE         | 305   | Bad type.                                                                                                                                                                                                                                                                                                                     |
| EPATHSTR      | 306   | Bad file/directory path string.                                                                                                                                                                                                                                                                                               |
| EBADBLOCK     | 307   | Block marked bad on the device.                                                                                                                                                                                                                                                                                               |
| EBADDATA      | 308   | Error detected in read data.                                                                                                                                                                                                                                                                                                  |
| EDRVBUSY      | 309   | Driver level is busy, new write not started.                                                                                                                                                                                                                                                                                  |
| EUNFLUSHABLE  | 310   | Cannot flush enough entries from cache to perform next read. There are pending dirty cache entries from a previous boot. Register all devices and this may go away. If not, there are dirty entries for a removable medium, which is not mounted. In this case, call <code>fatwtc_flushdev()</code> with the unregister flag. |
| EMISMATCH     | 311   | Parameter mismatch when registering a device. The device had outstanding cache entries from previous boot, but the caller is attempting to change the <code>cusize</code> (cache unit size) or removable status.                                                                                                              |
| EDEVNOTREG    | 312   | Internal error: device not registered when <code>_fatwtc_devwrite</code> called.                                                                                                                                                                                                                                              |
| EPARTIALWRITE | 313   | Internal error: not writing full physical sector in <code>_fatwtc_devwrite</code> .                                                                                                                                                                                                                                           |
| EJOVERFLOW    | 314   | Rollback journal overflow. Transaction requires too much data to be stored. Either increase <code>FAT_MAXRJ</code> in the BIOS, or review calling code to make sure transactions are terminated at the right time and do not journal unnecessary data.                                                                        |

**Table 2. FAT-Specific Error Codes**

| Code          | Value | Description                                                                                                                           |
|---------------|-------|---------------------------------------------------------------------------------------------------------------------------------------|
| ETRANSOPEN    | 315   | fatrj_transtart() called with transaction already open.                                                                               |
| EBROKENTIE    | 316   | Internal error: a tied cache group is in an inconsistent state.                                                                       |
| ETRANSNOTOPEN | 317   | fatrj_setchk() called without transaction being open.                                                                                 |
| ECMCONFLICT   | 318   | Transaction cannot contain both checkpoint and marker data.                                                                           |
| EFSTATE       | 319   | File is in an invalid state. Probably because the FATfile structure was not zero when opened for the first time.                      |
| EPSTATE       | 320   | Partition is in an invalid state. This occurs if you are trying to delete a file when another file is being allocated, or vice versa. |
| ECORRUPT      | 321   | FAT filesystem appears to be corrupted.                                                                                               |

## 12.5 More FAT Information

The FAT file system stores and organizes files on a storage device such as a hard drive or a memory device.

### 12.5.1 Clusters and Sectors

Every file is stored on one or more *clusters*. A cluster is made up of a contiguous number of bytes called *sectors* and is the smallest unit of allocation for files. The Dynamic C FAT implementation supports a sector size of 512 bytes. Cluster sizes depend on the media. The table below gives the cluster sizes used for some of our RabbitCore modules.

**Table 3. Cluster Sizes on Flash Devices**

| RabbitCore Model | Flash Device            | Number of Sectors per Cluster |
|------------------|-------------------------|-------------------------------|
| RCM 3700         | 1 MB Serial Flash       | 1                             |
| RCM 3300         | 4 and 8 MB Serial Flash | 2                             |
| RCM3360/70       | NAND Flash              | 32                            |

The cluster size for a NAND device corresponds to its page size. Note that a file or directory takes at minimum one cluster. On a NAND device the page size is 16K bytes; therefore, while it is allowable to write very small files to the FAT file system on a NAND device, it is not space efficient. Even the smallest file takes at least 16,000 bytes of storage. Cluster sizes for SD cards vary with the size of the card inserted. To determine the number of sectors per cluster on an SD card, divide the size of the card by 32MB.

### 12.5.2 The Master Boot Record

The *master boot record* (MBR) is located on one or more sectors at the physical start of the device. Its basic structure is illustrated in [Figure 3](#). The boot region of the MBR contains DOS boot loader code, which is written when the device is formatted (but is not otherwise used by the Dynamic C FAT file system). The partition table follows the boot region. It contains four 16-byte entries, which allows up to four partitions on the device. Partition table entries contain some critical information: the partition type (Dynamic C FAT recognizes partition types FAT12 and FAT16) and the partition's starting and ending sector numbers. There is also a field denoting the total number of sectors in the partition. If this number is zero, the corresponding partition is empty and available.

Figure 3. High-Level View of an MBR

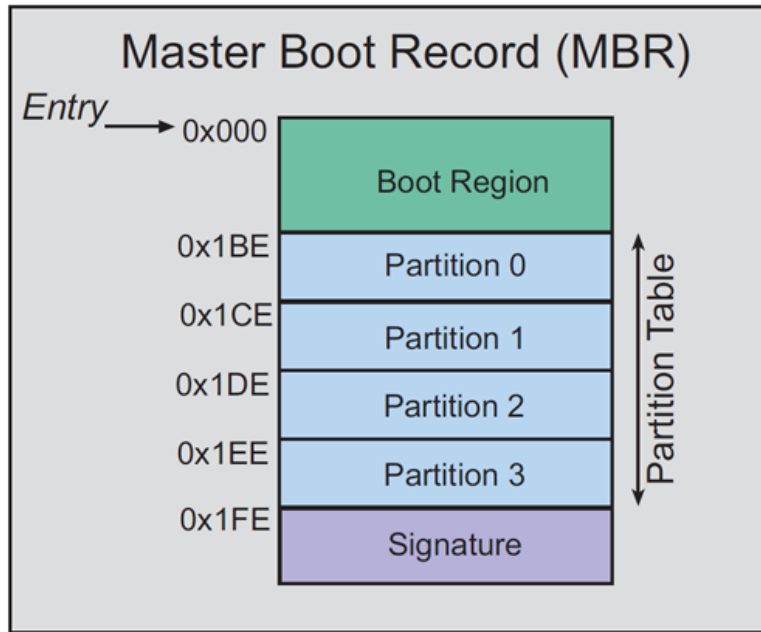

**NOTE:** Some devices are formatted without an MBR and, therefore, have no partition table. This configuration is not currently supported in the Dynamic C FAT file system.

### 12.5.3 FAT Partitions

The first sector of a valid FAT file system partition contains the *BIOS parameter block* (BPB); this is followed by the *file allocation table* (FAT), and then the *root directory*. The figure below shows a device with two FAT partitions.

Figure 4. Two FAT Partitions on a Device

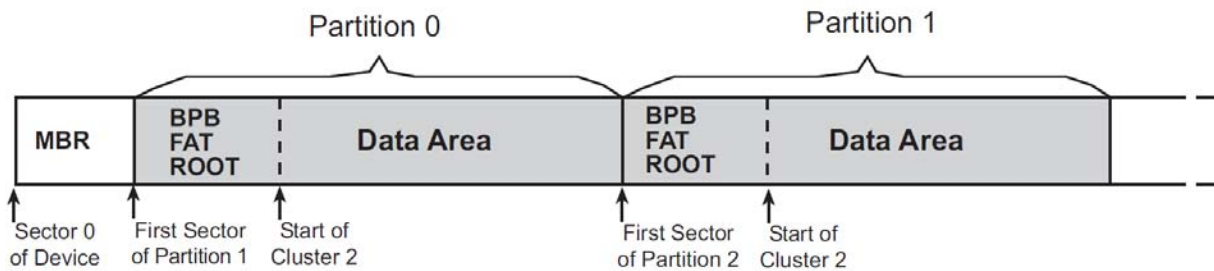

### 12.5.3.1 BPB

The fields of the BPB contain information describing the partition:

- the number of bytes per sector
- the number of sectors per cluster (see [Table 3](#))
- the total count of sectors on the partition
- the number of root directory entries
- plus additional information not mentioned here

The FAT type (FAT12 or FAT16) is determined by the count of clusters on the partition. The “12” and “16” refer to the number of bits used to hold the cluster number. The FAT type is calculated using information found in the BPB. Information from a BPB on a mounted partition is stored in the partition structure (of type `fat_part`) populated by `fat_AutoMount()`.

Partitions greater than or equal to 2 MB will be FAT16. Smaller partitions will be FAT12. To save code space, you can compile out support for either FAT type. Find the lines

```
#define FAT_FAT12 // comment out to disable FAT12 support
#define FAT_FAT16 // comment out to disable FAT16 support
```

in `LIB/.. /FAT.LIB`, make your change, and then recompile your application.

### 12.5.3.2 FAT

The file allocation table is the structure that gives the FAT file system its name. The FAT stores information about cluster assignments. A cluster is either assigned to a file, is available for use, or is marked as bad. A second copy of the FAT immediately follows the first.

### 12.5.3.3 Root Directory

The root directory has a predefined location and size. It has 512 entries of 32 bytes each. An entry in the root directory is either empty or contains a file or subdirectory name (in 8.3 format), file size, date and time of last revision and the starting cluster number for the file or subdirectory.

### 12.5.3.4 Data Area

The data area takes up most of the partition. It contains file data and subdirectories. Note that the data area of a partition must, by convention, start at cluster 2.

### 12.5.3.5 Creating Multiple FAT Partitions

FAT version 2.13 introduces `FAT_Write_MBR.c`, a utility that simplifies the creation of multiple partitions. (See [Section 12.4.1.2](#) for information on running this utility.) It is distributed with FAT version 2.13. It is also compatible with FAT versions 2.01, 2.05 and 2.10. If you have one of these earlier versions of the FAT and would like a copy of `FAT_Write_MBR.c`, please contact Technical Support either by email to [support@rabbitsemiconductor.com](mailto:support@rabbitsemiconductor.com) or by using the online form: [www.rabbit.com/support/questionSubmit.shtml](http://www.rabbit.com/support/questionSubmit.shtml).

Without the use of `FAT_Write_MBR.c`, creating multiple FAT partitions on the flash device requires a little more effort than the default partitioning. If the flash device does not contain an MBR, i.e., the device is not formatted, both `fat_Init()` and `fat_AutoMount()` return an error code (`-EUNFORMAT`)

indicating this fact. So the next task is to write the MBR to the device. This is done with a call to `fat_FormatDevice()`. Since we want more than one partition on the flash device, `fat_FormatDevice()` must be called with a mode parameter of zero.

Before calling `fat_FormatDevice()`, partition specific information must be set in the `mbr_part` entries for each partition you are creating. The following code shows possible information for partition 0 where `MY_PARTITION_SIZE` is equal to the size of the desired partition in bytes, 512 is the flash sector size, and `dev` points to the `mbr_part` structure.

```
memset(dev->part, 0, sizeof(mbr_part));
dev->part[0].starthead = 0xFE;
dev->part[0].endhead = 0xFE;
dev->part[0].startsector = 1;
dev->part[0].partseclsize = (MY_PARTITION_SIZE / 512) + 1;
dev->part[0].parttype = (dev->part[0].partseclsize < SEC_2MB) ? 1 : 6;
```

The `memset()` function is used to initialize the entry to zero. The values for `starthead` and `endhead` should be `0xFE` to indicate that the media uses LBA (Logical Block Addressing) instead of head and cylinder addressing. The FAT library uses LBA internally. The values for the `startsector`, `partseclsize` and `parttype` fields determine where the partition starts, how many sectors it contains and what partition type it is. The number of sectors in the partition is calculated by dividing the number of raw bytes in the partition by the sector size of the flash. The number of raw bytes in the partition includes not only bytes for file storage, but also the space needed by the BPB and the root directory. One is added to `dev->partseclsize` to ensure an extra sector is assigned if `MY_PARTITION_SIZE` is not evenly divisible by the size of a flash sector. The partition type (`.parttype`) is determined by the partition size: 1 indicates FAT12 and 6 indicates FAT16. Fill in an `mbr_part` structure for each partition you are creating. The remaining entries should be zeroed out.

When laying out partitions, there are three basic checks to make sure the partitions fit in the available device space and do not overlap.

1. No partition can start on a sector less than 1.
2. Each partition resides on sectors from `startsector` through `startsector+partseclsize-1`. No other partition can have a `startsector` value within that range.
3. No partition ending sector (`startsector+partseclsize-1`) can be greater than or equal to the total sectors on the device.

The partition boundaries are validated in the call to `fat_FormatDevice()` and the function will return an error if any of the partition boundaries are invalid. If `fat_FormatDevice()` returns success, then call `fat_AutoMount()` with flags of `FDDF_COND_PART_FORMAT | FDDF_MOUNT_DEV_# | FDDF_MOUNT_PART_ALL`; where `#` is the device number for the device being partitioned. This will format and mount the newly created partitions.

## 12.5.4 Directory and File Names

File and directory names are limited to 8 characters followed by an optional period (.) and an extension of up to 3 characters. The characters may be any combination of letters, digits, or characters with code point values greater than 127. The following special characters are also allowed:

```
$ % ' - _ @ ~ ` ! () { } ^ # &
```

File names passed to the file system are always converted to upper case; the original case value is lost.

The maximum size of a directory is limited by the available space. It is recommended that no more than ten layers of directories be used with the Dynamic C FAT file system.

## 12.5.5 $\mu$ C/OS-II and FAT Compatibility

Versions of the FAT file system prior to version 2.10 are compatible with  $\mu$ C/OS-II only if FAT API calls are confined to one  $\mu$ C/OS-II task. To make the FAT API reentrant from multiple tasks, you must do the following:

- Use FAT version 2.10
- #define FAT\_USE\_UCOS\_MUTEX before #using FAT.LIB
- Call the function `fat_InitUCOSMutex(priority)` after calling `OSInit()` and before calling FAT APIs or beginning multitasking; the parameter “priority” MUST be a higher priority than all tasks using FAT APIs
- Call only high-level fat APIs with names that begin with “fat\_”

See the function description for `fat_InitUCOSMutex()` for more details, and the sample program `Samples/FileSystem/FAT_UCOS.C` for a demonstration of using FAT with  $\mu$ C/OS-II.

## 12.5.6 SF1000 and FAT Compatibility

There are two macros that need to be defined for the FAT to work with the SF1000 Serial Flash Expansion Board.

```
#define SF_SPI_DIVISOR 5
#define SF_SPI_INVERT_RX
```

## 12.5.7 Hot-Swapping an xD Card

Hot-swapping is currently supported on the RCM3365 and the RCM3375. FAT version 2.10 or later is required. Two sample programs are provided in `Samples/FileSystem` to demonstrate this feature: `FAT_HOT_SWAP.C` and `FAT_HOT_SWAP_3365_75.C`. The samples are mostly identical: they both test for a keyboard hit to determine if the user wants to hot-swap the xD card, but, in addition, the sample program `FAT_HOT_SWAP_3365_75.C` also checks for a switch press and indicates a ready-to-mount condition with an LED.

After unmounting the xD card call `_fat_config_init()`. This disconnects drive and device structures from internal tables to work around a potential problem swapping from smaller to larger removable devices.

As demonstrated in the sample programs, an xD card should only be removed after it has unmounted with `fat_UnmountDevice()` and no operations are happening on the device.

Only `fat_AutoMount()` should be used to remount xD cards. In addition, the function `nf_XD_Detect()` should be called to verify xD card presence before attempting to remount an xD card.

xD cards formatted with versions of the FAT prior to 2.10 did not have unique volume labels. If there is a chance that two such cards may be swapped, call `fat_autoMount()` with the `FDDF_NO_RECOVERY` flag set. This means that if there is a write cache entry to be written, it will not be written. The function `fat_UnmountDevice()` flushes the cache (i.e., writes all cache entries to the device) before unmounting, so this should not generally be a problem if the device was properly unmounted.

## 12.5.8 Hot-Swapping an SD Card

Hot-swapping is currently supported on the RCM3900 and the RCM3910. FAT version 2.14 or later is required. A sample program is provided in `Samples/FileSystem` to demonstrate this feature: `FAT_HOT_SWAP_SD.C`. The sample tests for a keyboard hit to determine if the user wants to hot-swap the SD card.

Hot-swapping an SD card requires that you unmount the device before removal, as the FAT filesystem employs a cache system that may not have written all information to the device unless unmounted.

As demonstrated in the sample program, the SD card should only be removed after it has unmounted with `fat_UnmountDevice()` and no operations are happening on the device. Only `fat_AutoMount()` should be used to remount SD cards. In addition, the function `sdspi_debounce()` should be called to verify SD card presence before attempting to remount an SD card.

## 12.5.9 Unsupported FAT Features

At this time, the Dynamic C FAT file system does not support the following.

- Single-volume drives (they do not have an MBR)
- FAT32 or long file or directory names
- Sector sizes other than 512 bytes
- Direct parsing of relative paths
- Direct support of a “working directory”
- Drive letters (the FAT file system is not DOS)

## 12.5.10 References

There are a number of good references regarding FAT file systems available on the Internet. Any reasonable search engine will bring up many hits if you type in relevant terms, such as “FAT,” “file system,” “file allocation table,” or something along those lines. At the time of this writing, the following links provided useful information.

- This link is to Microsoft’s “FAT32 File System Specification,” which is also applicable to FAT12 and FAT16.

[www.microsoft.com/whdc/system/platform/firmware/fatgen.mspx](http://www.microsoft.com/whdc/system/platform/firmware/fatgen.mspx)

- This article gives a brief history of FAT.

[http://en.wikipedia.org/wiki/File\\_Allocation\\_Table](http://en.wikipedia.org/wiki/File_Allocation_Table)

- These tutorials give plenty of details plus links to more information:

[www.pcguide.com/ref/hdd/file/fat.htm](http://www.pcguide.com/ref/hdd/file/fat.htm)

[www.serverwatch.com/tutorials/article.php/2239651](http://www.serverwatch.com/tutorials/article.php/2239651)

# 13. USING ASSEMBLY LANGUAGE

This chapter gives the rules for mixing assembly language with Dynamic C code. A reference guide to the Rabbit Instruction Set is available from the Help menu of Dynamic C and is also documented in the *Rabbit Microprocessor Instruction Reference Manual* available on the Rabbit website:

[www.rabbitsemiconductor.com/docs/](http://www.rabbitsemiconductor.com/docs/)

## 13.1 Mixing Assembly and C

Dynamic C permits assembly language statements to be embedded in C functions and/or entire functions to be written in assembly language. C statements may also be embedded in assembly code. C-language variables may be accessed by the assembly code.

### 13.1.1 Embedded Assembly Syntax

Use the `#asm` and `#endasm` directives to place assembly code in Dynamic C programs. For example, the following function will add two 64-bit numbers together. The same program could be written in C, but it would be many times slower because C does not provide an add-with-carry operation (`adc`).

```
void eightadd(char *ch1, char *ch2){
#asm
 ld hl,(sp+@SP+ch2) ; get source pointer
 ex de,hl ; save in register DE
 ld hl,(sp+@SP+ch1) ; get destination pointer
 ld b,8 ; number of bytes
 xor a ; clear carry
loop:
 ld a,(de) ; ch2 source byte
 adc a,(hl) ; add ch1 byte
 ld (hl),a ; store result to ch1 address
 inc hl ; increment ch1 pointer
 inc de ; increment ch2 pointer
 djnz loop ; do 8 bytes
 ; ch1 now points to 64 bit result
#endasm
}
```

The keywords `debug` and `nodebug` can be placed on the same line as `#asm`. Assembly code blocks are `nodebug` by default. This saves space and unnecessary calls to the debugger kernel.

All blocks of assembly code within a C function are assembled in `nodebug` mode. The only exception to this is when a block of assembly code is explicitly marked with `debug`. Any blocks marked `debug` will be assembled in `debug` mode even if the enclosing C function is marked `nodebug`.

### 13.1.2 Embedded C Syntax

A C statement may be placed within assembly code by placing a “c” in column 1. Note that the registers used in the embedded C statement will be changed.

```
#asm
InitValues::
c start_time = 0;
c counter = 256;
 ret
#endasm
```

### 13.1.3 Setting Breakpoints in Assembly

There are two ways to enable software breakpoint support in assembly code.

One way is to explicitly mark the assembly block as `debug` (the default condition is `nodebug`). This causes the insertion of `RST 0x28` instructions between each assembly instruction. These `RST 0x28` instructions may cause jump relative (i.e., `jr`) instructions to go out of range, but this problem can be solved by changing the relative jump (`jr`) to an absolute jump (`jp`). Below is an example.

```
#asm debug
function::
...
ret
#endasm
```

The other way to enable breakpoint support in a block of assembly code is to add a C statement before the desired assembly instruction. Note that the assembly code must be contained in a debug C function to enable C code debugging. Below is an example.

```
debug dummyfunction() {
#asm
function::
...
label:
...
c ; // add line of C code to permit a breakpoint before jump relative
jr nc, label
ret
#endasm
}
```

**NOTE:** Single stepping through assembly code is always allowed if the assembly window is open.

Dynamic C 10.21 introduces support for the hardware breakpoint capability available with the Rabbit 4000 microprocessor. For more information on hardware breakpoints refer to [Section 14](#) and [Section 16.5](#) in this manual and/or the microprocessor user’s manual specific to your Rabbit (e.g., *Rabbit 4000 Microprocessor User’s Manual*).

### 13.1.4 Assembly and 32-bit Pointer Registers (PW, PX, PY, PZ)

Assembly programmers should note that `far` variables defined in C are interpreted as physical addresses by the assembler and `near` variables are interpreted as segmented logical addresses. Specifically, the instruction:

```
ld pd, klmn ; where pd is a 32-bit pointer register, and klmn is a 32-bit constant
```

does not work as would first be expected if used with a variable. For example, the following code snippet illustrates the problem:

Example (prints ‘Y’ not ‘X’ as may be expected):

```
char far * ptr;
char far foo;

int main()
{
 foo = 'Y';
 ptr = &foo;

 #asm
 ; The following code is INCORRECT!!!
 ld px, ptr ; ptr is in root, so px gets segmented version of ptr's address
 ld a, 'X'
 ld (px), a ; This does NOT store register a's contents to the address "&ptr" (i.e., foo)
 #endasm

 printf("%c\n", foo);
}
```

The incorrect code shown above illustrates how a programmer might write inline assembly to access a variable via a pointer. However, since the assembler treats `near` addresses as logical addresses, the format of the value produced by loading the variable “`ptr`” directly into a pointer register is not correct for the subsequent store instruction. To correctly implement the assembly in the above sample, do the following:

```
#asm
 ; Corrected version of incorrect code above
 ldl px, ptr ; ptr is in root, so load low word to a 32-bit register
 ; (high word is loaded with 0xFFFF to flag root address)

 ld px, (px) ; this loads foo's far physical address
 ld a, 'X'
 ld (px), a
#endasm
```

Replacing the first assembly block with the above listing will produce the expected result of printing “X.” The “`ldl`” instruction correctly loads the root address of “`ptr`” into `px`, making the subsequent “`ld`” instruction load `foo`’s far physical address into `px`. The above code has the virtue of being not only correct, but also small (11 bytes), fast (24 clocks) and spartan with regard to its register requirements (only 2 registers are needed).

Like the “`ldl`” instruction, the instructions “`convc`” and “`convd`” also convert logical addresses, though not to the equivalent physical address, but rather to the offset into the physical device.

## 13.2 Assembler and Preprocessor

The assembler parses most C language constant expressions. A C language constant expression is one whose value is known at compile time. All operators except the following are supported:

**Table 13-1. Operators Not Supported By The Assembler**

| Operator Symbol | Operator Description |
|-----------------|----------------------|
| ?:              | conditional          |
| .               | dot                  |
| ->              | points to            |
| *               | dereference          |

### 13.2.1 Comments

C-style comments are allowed in embedded assembly code. The assembler will ignore comments beginning with:

```
; text from the semicolon to the end of line is ignored.
// text from the double forward slashes to the end of line is ignored.
/* text between slash-asterisk and asterisk-slash is ignored */
```

### 13.2.2 Defining Constants

Constants may be created and defined in assembly code with the assembly language keyword `db` (**d**efine **b**yte). `db` should be followed immediately by numerical values and strings separated by commas. For example, each of the following lines define the string "ABC".

```
db 'A', 'B', 'C'
db "ABC"
db 0x41, 0x42, 0x43
```

The numerical values and characters in strings are used to initialize sequential byte locations.

If separate I&D space is enabled, assembly constants should either be put in their own assembly block with the `const` keyword or be done in C.

```
#asm const
 myrootconstants::
 db 0x40, 0x41, 0x42
#endasm
```

or

```
const char myrootconstants[] = { '\x40', '\x41', '\x42' }
```

If separate I&D space is enabled, `db` places bytes in the base segment of the data space when it is used with `const`. If the `const` keyword is absent, i.e.,

```
#asm
 myrootconstants::
 db 0x40, 0x41, 0x42
#endasm
```

the bytes are placed somewhere in the instruction space. If separate I&D space is disabled (the default condition), the bytes are placed in the base segment (aka, root segment) interspersed with code.

Therefore, so that data will be treated as data when referenced in assembly code, the `const` keyword must be used when separate I&D space is enabled. For example, this won't work correctly without `const`:

```
#asm const
label::
 db 0x5a
#endasm

main(){
 ;
#asm
 ld a, (label) // ld 0x5a to reg a
#endasm
}
```

The assembly language keyword `dw` defines 16-bit words, least significant byte first. The keyword `dw` should be followed immediately by numerical values:

```
dw 0x0123, 0xFFFF, xyz
```

This example defines three constants. The first two constants are literals, and the third constant is the address of variable `xyz`.

The numerical values initialize sequential word locations, starting at the current code address.

### 13.2.3 Multiline Macros

The Dynamic C preprocessor has a special feature to allow multiline macros in assembly code. The preprocessor expands macros before the assembler parses any text. Putting a `$\` at the end of a line inserts a new line in the text. This only works in assembly code. Labels and comments are not allowed in multiline macros.

```
#define SAVEFLAG $\
 ld a,b $\
 push af $\
 pop bc

#asm
 ...
 ld b,0x32
 SAVEFLAG
 ...
#endasm
```

### 13.2.4 Labels

A label is a name followed by one or two colons. A label followed by a single colon is *local*, whereas one followed by two colons is *global*. A local label is not visible to the code out of the current embedded assembly segment (i.e., code before the `#asm` or after the `#endasm` directive is outside of that embedded assembly segment).

Unless it is followed immediately by the assembly language keyword `equ`, the label identifies the current code segment address. If the label is followed by `equ`, the label “equates” to the value of the expression after the keyword `equ`.

Because C preprocessor macros are expanded in embedded assembly code, Rabbit recommends that preprocessor macros be used instead of `equ` whenever possible.

## 13.2.5 Special Symbols

This table lists special symbols that can be used in an assembly language expression.

**Table 13-2. Special Assembly Language Symbols**

| Symbol  | Description                                                                                                                                                                                                                  |
|---------|------------------------------------------------------------------------------------------------------------------------------------------------------------------------------------------------------------------------------|
| @SP     | Indicates the amount of stack space (in bytes) used for stack-based variables. This does not include arguments.                                                                                                              |
| @PC     | Constant for the current code location. For example:<br><pre>ld hl, @PC</pre> loads the code address of the instruction. <code>ld hl,@PC+3</code> loads the address after the instruction since it is a 3 byte instruction.  |
| @RETVAl | Evaluates the offset from the <i>frame reference point</i> to the stack space reserved for the <code>struct</code> function returns. See <a href="#">Section 13.3.3.2</a> for more information on the frame reference point. |
| @LENGTH | Determines the next reference address of a variable plus its size.                                                                                                                                                           |

## 13.2.6 C Variables

C variable names may be used in assembly language. What a variable name represents (the value associated with the name) depends on the variable. For a global or static local variable, the name represents the address of the variable in root memory. For an `auto` variable or formal argument, the variable name represents its own offset from the frame reference point.

The following list of processor register names are reserved and may not be used as C variable names in assembly: A, B, C, D, E, F, H, L, AF, HL, DE, BC, IX, IY, SP, PC, XPC, IP, IIR and EIR. The Rabbit 4000 has additional processor register names that are reserved: JK, PX, PY, PZ, PW, BCDE, JKHL, SU and HTR. Both upper and lower case instances are reserved for processor register names.

The name of a structure element represents the offset of the element from the beginning of the structure. In the following structure, for example,

```
struct s {
 int x;
 int y;
 int z;
};
```

the embedded assembly expression `s+x` evaluates to 0, `s+y` evaluates to 2, and `s+z` evaluates to 4, regardless of where structure “s” may be.

In nested structures, offsets can be composite, as shown here.

```
struct s{ // offset into s
 int x; // 0
 struct a { // 2 (i.e., sizeof(x))
 int b; // 2, offset is 0 relative to a
 int c; // 4, offset is 2 relative to a
 };
};
```

Just like in the first definition of structure “s”, the assembly expression `s+x` evaluates to 0; `s+a` evaluates to 2 and `s+b` evaluates to 2 (both expressions evaluate to the same value because both “a” and “b” are offset “0” from “a”); and finally, `s+c` evaluates to 4 because `s+a` evaluates to 2 and `a+c` evaluates to 2.

### 13.3 Stand-Alone Assembly Code

A stand-alone assembly function is one that is defined outside the context of a C language function.

A stand-alone assembly function has no `auto` variables and no formal parameters. It can, however, have arguments passed to it by the calling function. When a program calls a function from C, it puts the first argument into a *primary register*. If the first argument has one or two bytes (`int`, `unsigned int`, `char`, `pointer`), the primary register is HL (with register H containing the most significant byte). If the first argument has four bytes and is not a pointer (`long`, `unsigned long`, `float`), the primary register is BC:DE (with register B containing the most significant byte). If the first argument is a four byte pointer (`far *`), the primary register is PX. Assembly-language code can use the first argument very efficiently. *Only* the first argument is put into the primary register, while *all* arguments—including the first, pushed last—are pushed on the stack.

C function values return in the primary register, if they have four or fewer bytes, either in HL, BC:DE, or PX.

Assembly language allows assumptions to be made about arguments passed on the stack, and `auto` variables can be defined by reserving locations on the stack for them. However, the offsets of such implicit arguments and variables must be kept track of. If a function expects arguments or needs to use stack-based variables, Rabbit recommends using the embedded assembly techniques described in the next section.

### 13.3.1 Stand-Alone Assembly Code in Extended Memory

Stand-alone assembly functions may be placed in extended memory by adding the `xmem` keyword as a qualifier to `#asm`, as shown below. Care needs to be taken so that branch instructions do not jump beyond the current `xmem` window. To help prevent such bad jumps, the compiler limits `xmem` assembly blocks to 4096 bytes. Code that branches to other assembly blocks in `xmem` should always use `ljmp` or `lcall`.

```
#asm xmem
main::
...
lcall fcn_in_xmem
...
lret
#endasm

#asm xmem
fcn_in_xmem::
...
lret
#endasm
```

### 13.3.2 Example of Stand-Alone Assembly Code

The stand-alone assembly function `foo()` can be called from a Dynamic C function.

```
int foo (int); // A function prototype can be declared for stand-alone
 // assembly functions, which will cause the compiler
 // to perform the appropriate type-checking.

main(){
 int i,j;
 i=1;
 j=foo(i);
}

#asm
foo::
...
ld hl,2 // The return value expected by main() is put
ret // in HL just before foo() returns
#endasm
```

The entire program can be written in assembly.

```
#asm
main::
...
ret
#endasm
```

### Embedded Assembly Code

When embedded in a C function, assembly code can access arguments and local variables (either `auto` or `static`) by name. Furthermore, the assembly code does not need to manipulate the stack because the functions `prolog` and `epilog` already do so.

### 13.3.3 The Stack Frame

The purpose and structure of a *stack frame* should be understood before writing embedded assembly code. A stack frame is a run-time structure on the stack that provides the storage for all `auto` variables, function arguments and the return address for a particular function. If the IX register is used for a frame reference pointer, the previous value of IX is also kept in the stack frame.

#### 13.3.3.1 Stack Frame Diagram

Figure 13.1 shows the general appearance of a stack frame.

Figure 13.1 Assembly Code Stack Frame

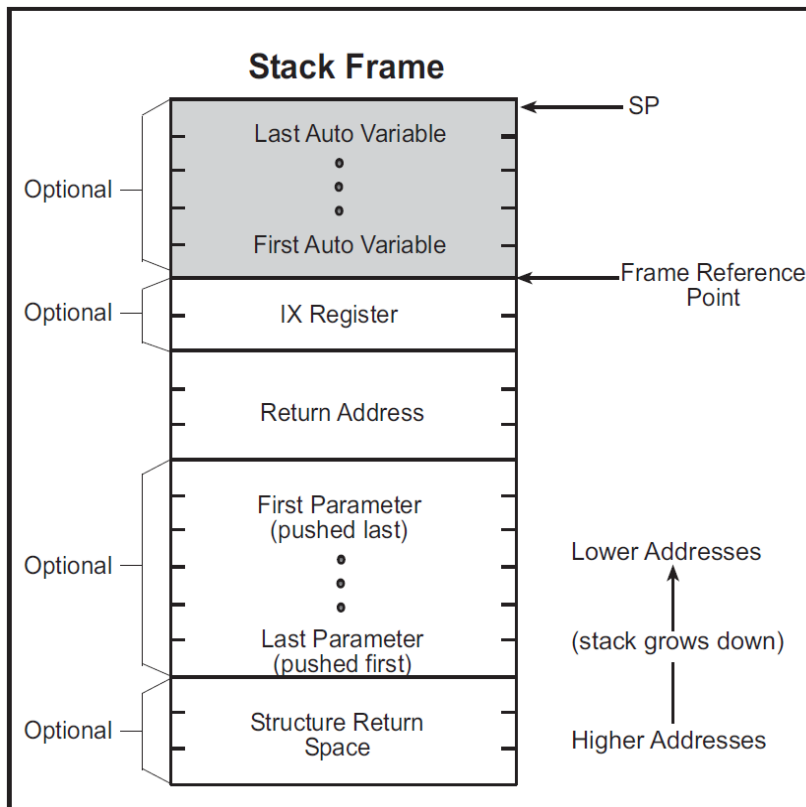

The return address is always necessary. The presence of auto variables depends on the function definition. The presence of arguments and structure return space depends on the function call. (The stack pointer may actually point lower than the indicated mark temporarily because of temporary information pushed on the stack.)

The shaded area in the stack frame is the stack storage allocated for `auto` variables. The assembler symbol `@SP` represents the size of this area.

#### 13.3.3.2 The Frame Reference Point

The frame reference point is a location in the stack frame that immediately follows the function's return address. The IX register may be used as a pointer to this location by putting the keyword `useix` before the function, or the request can be specified globally by the compiler directive `#useix`. The default is `#nouseix`. If the IX register is used as a frame reference pointer, its previous value is pushed on the stack after the function's return address. The frame reference point moves to encompass the saved IX value.

### 13.3.4 Embedded Assembly Example

The purpose of the following sample program, `asm1.c`, is to show the different ways to access stack-based variables from assembly code.

```
void func(char ch, int i, long lg);
main(){
 char ch;
 int i;
 long lg;

 ch = 0x11;
 i = 0x2233;
 lg = 0x44556677L;
 func(ch,i,lg);
}

void func(char ch, int i, long lg){
 auto int x;
 auto int z;

 x = 0x8888;
 z = 0x9999;

 #asm
 // This is equivalent to the C statement: x = 0x8888
 ld hl, 0x8888
 ld (sp+@SP+x), hl

 // This is equivalent to the C statement: z = 0x9999
 ld hl, 0x9999
 ld (sp+@SP+z), hl

 // @SP+i gives the offset of i from the stack frame on entry.
 // On the Rabbit, this is how HL is loaded with the value in i.
 ld hl, (sp+@SP+i)

 // This works if func() is useix; however, if the IX register
 // has been changed by the user code, this code will fail.
 ld hl, (ix+i)

 // This method works in either case because the assembler adjusts the
 // constant @SP, so changing the function to nouseix with the keyword
 // nouseix, or the compiler directive #nouseix will not break the code.
 // But, if SP has been changed by user code, (e.g., a push) it won't work.
 ld hl, (sp+@SP+lg+2)
 ld b,h
 ld c,L
 ld hl, (sp+@SP+lg)
 ex de,hl
 #endasm
}
```

### 13.3.5 The Disassembled Code Window

A program may be debugged at the assembly level by opening the Disassembled Code window (aka, the Assembly window). Single stepping and breakpoints are supported in this window. When the “Disassembled Code” window is open, single stepping occurs instruction by instruction rather than statement by statement. The figure below shows the “Disassembled Code” window for the example code, `asm1.c`.

Figure 13.2 Disassembled Code Window

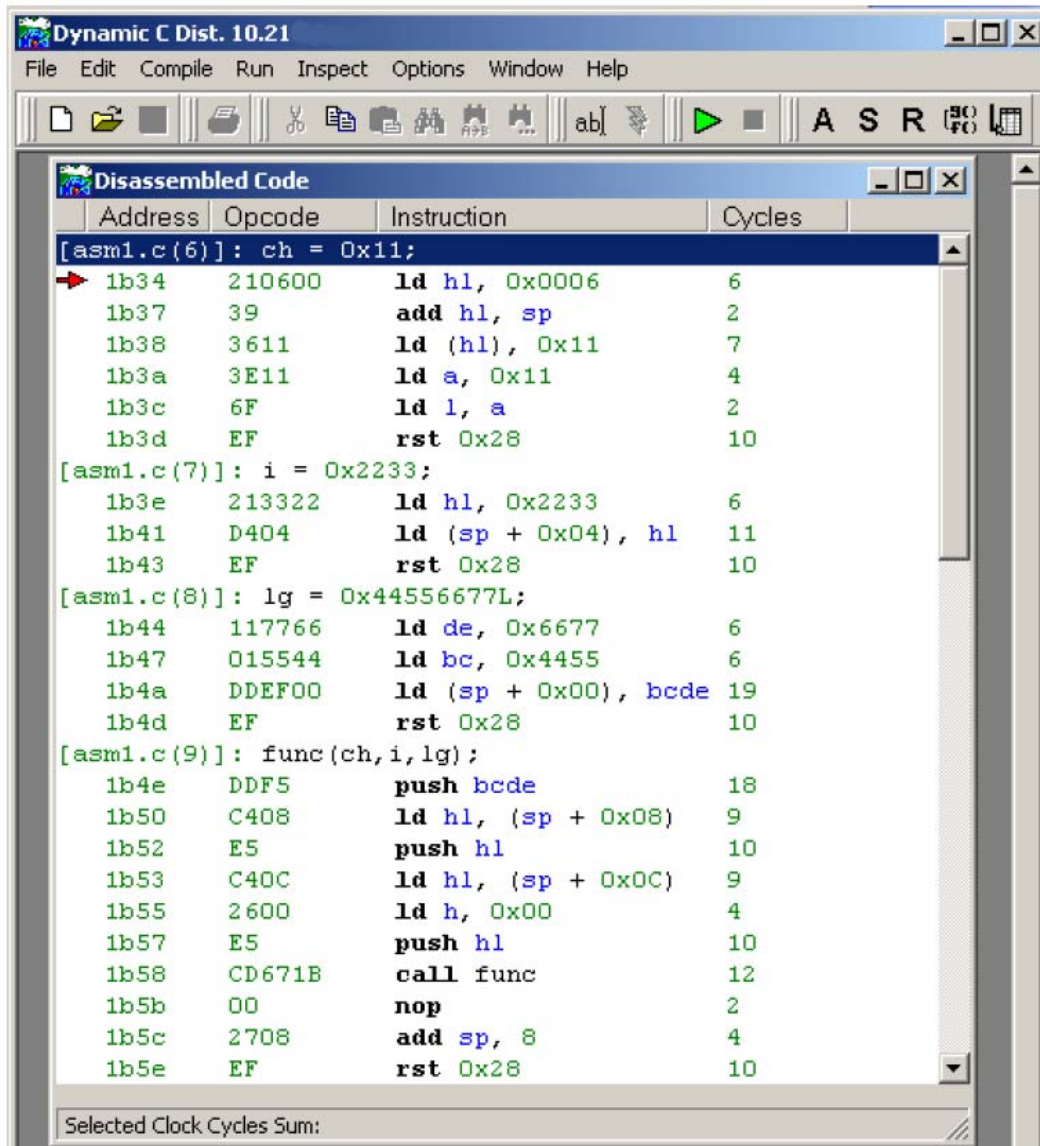

The Disassembled Code window shows the memory address on the far left, followed by the opcode bytes, followed by the mnemonics for the instruction. The last column shows the number of cycles for the instruction, assuming no wait states. The total cycle time for a block of instructions will be shown at the bottom of the window when the block is selected. The total assumes one execution per instruction, so the user must take looping and branching into consideration when evaluating execution times.

### 13.3.6 Local Variable Access

Accessing static local variables is simple because the symbol evaluates to the address directly. The following code shows, for example, how to load static variable `y` into HL.

```
ld hl, (y) ; load hl with contents of y
```

#### 13.3.6.1 Using the IX Register as a Frame Pointer

Using IX as a frame pointer is a convenient way to access stack variables in assembly. Using SP requires extra bookkeeping when values are pushed on or popped off the stack.

Now, access to stack variables is easier. Consider, for example, how to load `ch` into register A.

```
ld a, (ix+ch) ; a <-- ch
```

The IX+offset load instruction takes 9 clock cycles and opcode is three bytes. If the program needs to load a four-byte variable such as `lg`, the IX+offset instructions are as follows.

```
ld hl, (ix+lg+2) ; load LSB of lg
ld b, h ; longs are normally stored in BC:DE
ld c, L
ld hl, (ix+lg) ; load MSB of lg
ex de, hl
```

This takes a total of 24 cycles.

The offset from IX is a signed 8-bit integer. To use IX+offset, the variable must be within +127 or -128 bytes of the frame reference point. The @SP method is the only method for accessing variables out of this range. The @SP symbol may be used even if IX is the frame reference pointer.

#### 13.3.6.2 Using Index Registers as Pointers to Aggregate Types

The members of Dynamic C aggregate types (structures and unions) can be accessed from within a block of assembly code using any of the index registers:

- IX, IY, SP (available on all Rabbit processors)
- PW, PX, PY or PZ (available on the Rabbit 4000+)

The assembly notation for accessing a member of a structure or union is:

```
(index_register + [aggregate_type_reference] + member_name)
```

where `aggregate_type_reference` may be any one of a typedef for, an instance of, or a pointer to an instance of the aggregate type. If `member_name` is an aggregate type (e.g. a nested structure) then members of the nested aggregate type are accessed as follows:

```
(index_register + [aggregate_type_reference] + member_name + member_of_member_name)
```

where `member_of_member_name` is a member of struct `member_name` which is itself a member of the `aggregate_type_reference`. To access additional levels of nested structures, add "+ member\_name" as necessary.

The following Rabbit 4000+ example illustrates assembly code access of both near data and far data in both a base structure and its nested structure, using a mix of struct typedef, struct pointer and struct instance references:

```
typedef struct {
 int x;
 int y;
} TNest;

typedef struct {
 TNest nest;
 long time;
} TStruct;

void func(TStruct *s, TStruct far *t)
{
 #asm nodebug
 ; e.g. use IY to access near (root) data:
 ld iy, (sp+@SP+s)
 ld hl, (iy+[TStruct]+nest+y)
 ; . . .
 ; e.g. use PW to access far data:
 ld pw, (sp+@SP+t)
 ld bcde, (pw+[t]+time)
 ; . . .
#endasm
}

void main(void)
{
 auto TStruct s_local;
 static far TStruct t_local;

 _n_memset(&s_local, 0, sizeof s_local);
 s_local.nest.y = 0x1234;

 _f_memset(&t_local, 0, sizeof t_local);
 t_local.time = 0x12345678;

 func(&s_local, &t_local);

 #asm nodebug
 ; e.g. use IY to access near (root) data:
 ld iy, @SP+s_local
 add iy, sp
 ld hl, (iy+[s_local]+nest+y)
 ; . . .
 ; e.g. use PW to access far data:
```

```

 ld pw, t_local
 ld bcde, (pw+[t_local]+time)
; . . .
; e.g. use PW to access near (root) data:
 ld hl, @SP+s_local
 add hl, sp
 ldl pw, hl
 ld hl, (pw+[t_local]+nest+y)
; . . .
#endasm
}

```

### 13.3.6.3 Functions in Extended Memory

If the `xmem` keyword is present, Dynamic C compiles the function to extended memory. Otherwise, Dynamic C determines where to compile the function. Functions compiled to extended memory have a 3-byte return address instead of a 2-byte return address.

Because the compiler maintains the offsets automatically, there is no need to worry about the change of offsets. The `@SP` approach discussed previously as a means of accessing stack-based variables works whether a function is compiled to extended memory or not, as long as the C-language names of local variables and arguments are used.

A function compiled to extended memory can use `IX` as a frame reference pointer as well. This adds an additional two bytes to argument offsets because of the saved `IX` value. Again, the `IX+offset` approach discussed previously can be used because the compiler maintains the offsets automatically.

## 13.4 C Calling Assembly

Dynamic C does not assume that registers are preserved in function calls. In other words, the function being called need not save and restore registers.

### 13.4.1 Passing Parameters

When a program calls a function from C, it puts the first argument into `HL` (if it has one or two bytes) with register `H` containing the most significant byte. If the first argument has four bytes, it goes in `BC:DE` (with register `B` containing the most significant byte). Only the first argument is put into the primary register, while *all* arguments—including the first, pushed last—are pushed on the stack.

## 13.4.2 Location of Return Results

If a C-callable assembly function is expected to return a result (of primitive type), the function must pass the result in the “primary register.” If the result is an `int`, `unsigned int`, `char`, or a pointer, return the result in HL (register H contains the most significant byte). If the result is a `long`, `unsigned long`, or `float`, return the result in BCDE (register B contains the most significant byte). A C function containing embedded assembly code may, of course, use a `C return` statement to return a value. A stand-alone assembly routine, however, must load the primary register with the return value before the `ret` instruction.

## 13.4.3 Returning a Structure

In contrast, if a function returns a structure (of any size), the calling function reserves space on the stack for the return value before pushing the last argument (if any). Dynamic C functions containing embedded assembly code may use a `C return` statement to return a value. A stand-alone assembly routine, however, must store the return value in the structure return space on the stack before returning.

Inline assembly code may access the stack area reserved for structure return values by the symbol `@RETVAL`, which is an offset from the frame reference point.

The following code shows how to clear field `f1` of a structure (as a returned value) of type `struct s`.

```
typedef struct ss {
 int f0; // first field
 char f1; // second field
} xyz;
xyz my_struct;
...
my_struct = func();
...
xyz func(){
#asm
 ...
 xor a ; clear register A.
 ld hl,@SP+@RETVAL+ss+f1 ; hl <- the offset from SP to f1 field of returned struct
 add hl,sp ; hl now points to f1.
 ld (hl),a ; load a (now 0) to f1.
 ...
#endasm
}
```

It is crucial that `@SP` be added to `@RETVAL` because `@RETVAL` is an offset from the frame reference point, not from the current SP.

## 13.5 Assembly Calling C

A program may call a C function from assembly code. To make this happen, set up part of the stack frame prior to the call and “unwind” the stack after the call. The procedure to set up the stack frame is described here.

1. Save all registers that the calling function wants to preserve. A called C function may change the value of any register. (Pushing registers values on the stack is a good way to save their values.)
2. If the function return is a `struct`, reserve space on the stack for the returned structure. Most functions do not return structures.
3. Compute and push the last argument, if any.
4. Compute and push the second to last argument, if any.
5. Continue to push arguments, if there are more.
6. Compute and push the first argument, if any. Also load the first argument into the primary register (HL for `int`, `unsigned int`, `char`, and pointers, or BCDE for `long`, `unsigned long`, and `float`) if it is of a primitive type.
7. Issue the call instruction.

The caller must unwind the stack after the function returns.

1. Recover the stack storage allocated to arguments. With no more than 6 bytes of arguments, the program may pop data (2 bytes at time) from the stack. Otherwise, it is more efficient to compute a new SP instead. The following code demonstrates how to unwind arguments totaling 36 bytes of stack storage.

```
; Note that HL is changed by this code!
; Use "ex de,hl" to save HL if HL has the return value
;; ex de,hl ; save HL (if required)
 ld hl,36 ; want to pop 36 bytes
 add hl,sp ; compute new SP value
 ld sp,hl ; put value back to SP
;; ex de,hl ; restore HL (if required)
```

2. If the function returns a `struct`, unload the returned structure.
3. Restore registers previously saved. Pop them off if they were stored on the stack.
4. If the function return was not a `struct`, obtain the returned value from HL or BCDE.

## 13.6 Interrupt Routines in Assembly

Interrupt Service Routines (ISRs) may be written in Dynamic C (declared with the keyword `interrupt`). But since an assembly routine may be more efficient than the equivalent C function, assembly is more suitable for an ISR. Even if the execution time of an ISR is not critical, the latency of one ISR may affect the latency of other ISRs.

Either stand-alone assembly code or embedded assembly code may be used for ISRs. The benefit of embedding assembly code in a C-language ISR is that there is no need to worry about saving and restoring registers or reenabling interrupts. The drawback is that the C interrupt function does save all registers, which takes some amount of time. A stand-alone assembly routine needs to save and restore only the registers it uses.

### 13.6.1 Steps Followed by an ISR

The CPU loads the Interrupt Priority register (IP) with the priority of the interrupt before the ISR is called. This effectively turns off interrupts that are of the same or lower priority. Generally, the ISR performs the following actions:

1. Save all registers that will be used, i.e., push them on the stack. Interrupt routines written in C save all registers automatically. Stand-alone assembly routines must push the registers explicitly.
2. Push and pop the LXPC as a defensive programming strategy to avoid corrupting large memory support. For example, the LCALL instruction clears the LXPC so it is essential that this register is saved before issuing an LCALL and restored after the LRET.
3. Determine the cause of the interrupt. Some devices map multiple causes to the same interrupt vector. An interrupt handler must determine what actually caused the interrupt.
4. Remove the cause of the interrupt.
5. If an interrupt has more than one possible cause, check for all the causes and remove all the causes at the same time.
6. When finished, restore registers saved on the stack. Naturally, this code must match the code that saved the registers. Interrupt routines written in C perform this automatically. Stand-alone assembly routines must pop the registers explicitly.
7. Restore the interrupt priority level so that other interrupts can get the attention of the CPU. ISRs written in C restore the interrupt priority level automatically when the function returns. However, stand-alone assembly ISRs must restore the interrupt priority level explicitly by calling `ipres`.

The interrupt priority level must be restored immediately before the return instructions `ret` or `reti`. If the interrupts are enabled earlier, the system can stack up the interrupts. This may or may not be acceptable because there is the potential to overflow the stack.

8. Return. There are two types of interrupt returns: `ret` and `reti`.

The value in IP is shown in the status bar at the bottom of the Dynamic C window. If a breakpoint is encountered, the IP value shown on the status bar reflects the saved context of IP from just before the breakpoint.

### 13.6.2 Modifying Interrupt Vectors

This section will discuss how to modify the interrupt vectors after they have been set up. For detailed information about how the interrupt vectors are set up and operate, please see the *Rabbit 4000 Designer's Handbook*.

Users can modify interrupt vector code under all program models in one of two ways

- Reading the interrupt CPU registers directly (IER and EIR)
- Using the configuration macros (INTVEC\_BASE and XINTVEC\_BASE)

As noted, the 8-bit CPU registers are called IIR and EIR corresponding to internal interrupts and external interrupts, respectively. Likewise, the macros are called INTVEC\_BASE and XINTVEC\_BASE. When Rabbit's BIOS finishes initial tasks, the macros and registers correlate directly. Therefore, if a user application does not modify the interrupt vector registers then that user may employ the macros for the entire program execution. If the application alters the interrupt vector registers during execution (not recommended practice), however, the application must use the values of those registers instead of the macros.

For detailed information on the operation of interrupt vectors, consult the chip manual for your board, e.g., *The Rabbit 4000 Microprocessor User's Manual*. The remainder of this section explains how to modify interrupt vectors after initialization.

In C, the user can modify interrupt vectors through `SetVectIntern()` and `SetVectExtern()`. In assembly, the user accomplishes the same through `INTVEC_BASE + <vector offset>` or `XINTVEC_BASE + <vector offset>`. The possible values for `<vector offset>` are defined as macros in `lib\..\bioslib\sysio.lib`, listed below for convenience:

**Table 13-3. Internal Interrupts and their Offset from INTVEC\_BASE**

|              |             |
|--------------|-------------|
| INPUTCAP_OFS | SERC_OFS    |
| NETA_OFS     | SERD_OFS    |
| PERIODIC_OFS | SERE_OFS    |
| PWM_OFS      | SERF_OFS    |
| QUAD_OFS     | SLAVE_OFS   |
| RST10_OFS    | SLV_OFS     |
| RST18_OFS    | SMV_OFS     |
| RST20_OFS    | SYSCALL_OFS |
| RST28_OFS    | TIMERA_OFS  |
| RST38_OFS    | TIMERB_OFS  |
| SECWD_OFSS   | TIMERC_OFS  |
| SERA_OFS     | WPV_OFS     |
| SERB_OFS     |             |

**Table 13-4. External Interrupts and their Offset from XINTVEC\_BASE**

|          |          |
|----------|----------|
| BKPT_OFS | DMA5_OFS |
| DMA0_OFS | DMA6_OFS |
| DMA1_OFS | DMA7_OFS |
| DMA2_OFS | EXT0_OFS |
| DMA3_OFS | EXT1_OFS |
| DMA4_OFS |          |

The following code fragments set up the interrupt service routine for the timer B interrupt:

```
#asm
 ;*** Dynamic Method ***
 clr hl
 ld a, iir
 ld h, a
 ld de, TIMERB_OFS ; Load offset of interrupt
 add hl, de
 ld de, 0xC3 | timerb_isr << 8 ; Jump opcode and LSB of address.
 Ld bc, timerb_isr >> 8 ; MSB of address
 ld (hl), bcde
#endasm

#asm
 ;*** Static Method ***
 ld a, 0xC3 ; Jump opcode
 ld hl, timerb_isr ; Service routine
 ld (INTVEC_BASE + PERIODIC_OFS), a
 ld (INTVEC_BASE + PERIODIC_OFS + 1), hl
#endasm
```

The static method shown above is equivalent to using `SetVectIntern()` or `SetVectExtern()`, although these functions perform more safety checks that writing assembly code would circumvent. Please see the *Dynamic C Function Reference Manual* for more information on using `SetVectIntern()` and `SetVectExtern()`.

## 13.7 Common Problems

If you have problems with your assembly code, consider the possibility of any of the following situations:

- **Unbalanced stack**

Ensure the stack is “balanced” when a routine returns. In other words, the SP must be same on exit as it was on entry. From the caller’s point of view, the SP register must be identical before and after the call instruction.

- **Using the @SP approach after pushing temporary information on the stack**

The @SP approach for inline assembly code assumes that SP points to the low boundary of the stack frame. This might not be the case if the routine pushes temporary information onto the stack. The space taken by temporary information on the stack must be compensated for.

The following code illustrates the concept.

```
 ; SP still points to the low boundary of the call frame
 push hl ; save HL

 ; SP now two bytes below the stack frame!
 ...
 ld hl,@SP+x+2 ; Add 2 to compensate for altered SP
 add hl,sp ; compute as normal
 ld a,(hl) ; get the content
 ...
 pop hl ; restore HL

 ; SP again points to the low boundary of the call frame
```

- **Registers not preserved**

In Dynamic C, the caller is responsible for saving and restoring all registers. An assembly routine that calls a C function must assume that all registers will be changed.

Unpreserved registers in interrupt routines cause unpredictable and unrepeatabe problems. In contrast to normal functions, interrupt functions are responsible for saving and restoring all registers themselves.

- **Relocatable code**

Jump relative (JR) instructions allow easier code relocation because the jump is relative to the current program counter. For example, RAM functions are usually written in assembly and are relocated to RAM from flash. A jump (JP) instruction would not work in this case because the jump would be to a flash location and not the intended RAM location. Using JR instead of JP will jump to the intended RAM location.

## 14. KEYWORDS

A keyword is a reserved word in C that represents a basic C construct. It cannot be used for any other purpose.

---

---

### **abandon**

---

---

Used in single-user cofunctions, `abandon{ }` must be the first statement in the body of the cofunction. The statements inside the curly braces will be executed only if the cofunction is forcibly abandoned and if a call to `loophead( )` is made in `main( )` before calling the single-user cofunction. See `Samples\Cofunc\Cofaband.c` for an example of abandonment handling.

---

---

### **abort**

---

---

Jumps out of a costatement.

```
for(;;){
 costate {
 ...
 if(condition) abort;
 }
 ...
}
```

---

---

## align

---

---

Used in assembly blocks, the `align` keyword outputs a padding of nops so that the next instruction to be compiled is placed at the boundary based on `VALUE`.

```
#asm
...
align <VALUE>
...
#endasm
```

`VALUE` can have any (positive) integer expression or the special operands `even` and `odd`. The operand `even` aligns the instruction on an even address, and `odd` on an odd address. Integer expressions align on multiples of the value of the expression.

Some examples:

```
align odd ; This aligns on the next odd address
align 2 ; Aligns on a 16-bit (2-byte) boundary
align 4 ; Aligns on a 32-bit (4-byte) boundary
align 100h ; Aligns the code to the next address that is evenly divisible by 0x100
align sizeof(int)+4 ; Complex expression, involving sizeof and integer constant
```

Note that integer expressions are treated the same way as operand expressions for other asm operators, so variable labels are resolved to their addresses, not their values.

---

---

## always\_on

---

---

The costatement is always active. Unnamed costatements are always on.

---

---

## anymem

---

---

Allows the compiler to determine in which part of memory a function will be placed.

```
anymem int func(){
 ...
}
#memmap anymem
#asm anymem
...
#endasm
```

---

---

## asm

---

---

Use in Dynamic C code to insert one assembly language instruction. If more than one assembly instruction is desired use the compiler directive #asm instead.

```
int func() {
 int x,y,z;
 asm ld hl,0x3333
 ...
}
```

---

---

## auto

---

---

A functions's local variable is located on the system stack and exists as long as the function call does.

```
int func(){
 auto float x;
 ...
}
```

---

---

## bbram

---

---

**IMPORTANT:** bbram does not provide data integrity; instead, use the keyword **protected** to ensure integrity of data across power failures.

Identifies a variable with static local or global extent/scope for storage in battery-backed RAM on boards with more than one RAM device. Generally, the battery-backed RAM is attached to CS1 due to the low-power requirements. Other than its assigned root or far data location, a bbram variable is identical to a normal root or far variable. In the case of a reset or power failure, the value of a bbram variable is preserved, but not atomically like with protected variables. No software check is possible to ensure that the RAM is battery-backed. This requirement must be enforced by the user. Note that bbram variables must have either static or global storage.

For boards that utilize fast SRAM in addition to a battery-backed SRAM the size of the battery-backed root data space is specified by a BIOS macro called BBROOTDATASIZE (default value is 4K). Note that this macro is defined to zero for boards with only a single SRAM.

See the *Rabbit 4000 Microprocessor Designer's Handbook* for information on how the second data area is reserved.

On boards with a single RAM, bbram variables will be treated the same as normal root or far variables. No warning will be given; the bbram keyword is simply ignored when compiling to boards with a single RAM with the assumption that the RAM is battery-backed. Please refer to the function description for `_xalloc()` for information on how to allocate battery-backed data in xmem.

---

---

## break

---

---

Jumps out of a loop, if, or case statement.

```
while(expression){
 ...
 if(condition) break;
}
switch(expression){
 ...
 case 3:
 ...
 break;
 ...
}
```

---

---

## c

---

---

Use in assembly block to insert one Dynamic C instruction.

```
#asm
InitValues::
c start_time = 0;
c counter = 256;
 ld hl,0xa0;
 ret
#endasm
```

---

---

## case

---

---

Identifies the next case in a `switch` statement.

```
switch(expression){
 case constant:
 ...
 case constant:
 ...
 case constant:
 ...
 ...
}
```

---

---

## char

---

---

Declares a variable or array element as an unsigned 8-bit character.

```
char c, x, *string = "hello";
int i;
...
c = (char)i; // type casting operator
```

---

---

## cofunc

---

---

Indicates the beginning of a cofunction.

```
cofunc|scofunc type [name][[dim]]([type arg1, ..., type argN])
{ [statement | yield; | abort; | waitfor(expression);]... }{
 ...
}
```

### **cofunc, scofunc**

The keywords `cofunc` or `scofunc` (a single-user cofunction) identify the statements enclosed in curly braces that follow as a cofunction.

### **type**

Whichever keyword (`cofunc` or `scofunc`) is used is followed by the data type returned (`void`, `int`, etc.).

### **name**

A name can be any valid C name not previously used. This results in the creation of a structure of type `CoData` of the same name.

### **dim**

The cofunction name may be followed by a dimension if an indexed cofunction is being defined.

### **cofunction arguments (arg1, . . . , argN)**

As with other Dynamic C functions, cofunction arguments are passed by value.

### **cofunction body**

A cofunction can have as many C statements, including `abort`, `yield`, `waitfor`, and `waitfordone` statements, as needed. Cofunctions can contain calls to other cofunctions.

---

---

## const

---

---

This keyword declares that a value will be stored in flash, thus making it unavailable for modification.

`const` is a type qualifier and may be used with any static or global type specifier (`char`, `int`, `struct`, etc.). The `const` qualifier appears before the type unless it is modifying a pointer. When modifying a pointer, the `const` keyword appears after the "\*."

The `const` keyword in Dynamic C obeys the rules set forth in the ANSI-C89/ISO-C90 specification. Prior to Dynamic C 10.64, the behavior of **const** differed considerably. See [Section 4.4 “The const Keyword”](#) for an explanation of the differences and some examples that show how to update code from older Dynamic C applications to utilize the new functionality.

---

---

## continue

---

---

Skip to the next iteration of a loop.

```
while(expression){
 if(nothing to do) continue;
 ...
}
```

---

---

## costate

---

---

Indicates the beginning of a costatement.

```
costate [name [state]] {
 ...
}
```

Name can be absent. If name is present, `state` can be `always_on` or `init_on`. If `state` is absent, the costatement is initially off.

---

---

## debug

---

---

Indicates a function is to be compiled in debug mode. This is the default case for Dynamic C functions with the exception of pure assembly language functions.

Library functions compiled in debug mode can be single stepped into, and breakpoints can be set in them.

```
debug int func(){
 ...
}
#asm debug
 ...
#endasm
```

The debug keyword in combination with the norst keyword will give you run-time checking without debug. For example,

```
debug norst foo() {
}
```

will perform run-time checking if enabled, but will not have rst instructions.

---

---

## default

---

---

Identifies the default case in a switch statement. The default case is optional. It executes only when the switch expression does not match any other case.

```
switch(expression){
 case const1:
 ...
 case const2:
 ...
 default:
 ...
}
```

---

---

## do

---

---

Indicates the beginning of a do loop. A do loops tests at the end and executes at least once.

```
do
 ...
while(expression);
```

The statement must have a semicolon at the end.

---

---

## else

---

---

The false branch of an `if` statement.

```
if(expression)
 statement // "statement" executes when "expression" is true
else
 statement // "statement" executes when "expression" is false
```

---

---

## enum

---

---

Defines a list of named integer constants:

```
enum foo {
 white, // default is 0 for the first item
 black, // will be 1
 brown, // will be 2
 spotted = -2, // will be -2
 striped, // will be -3
};
```

An `enum` can be declared in local or global scope. The tag `foo` is optional; but it allows further declarations:

```
enum foo rabbits;
```

To see a colorful sample of the `enum` keyword, run `/samples/enum.c`.

---

---

## extern

---

---

Indicates that a variable is defined in the BIOS, later in a library file, or in another library file. Its main use is in module headers.

```
/**/ BeginHeader ..., var */
extern int var;
/**/ EndHeader */
int var;
...
```

---

---

## far

---

---

This keyword, when used in a variable declaration, tells the compiler to allocate storage for that variable from the far memory space (a.k.a. the physical address space). The `far` qualifier indicates that physical addressing will be used with all occurrences of the variable. The `far` type qualifier may be used with any static or global type specifier (`char`, `int`, `struct`, etc.). The `far` qualifier may appear before or after a basic or aggregate type. When modifying a pointer, the `far` keyword appears after the “\*” in the declaration.

The use of `far` is very similar to that of the `const` qualifier in that it may only be applied to global or static variables. However, as shown in Example 1, `far` may come before or after the basic type (allowing `far` after the type is compatible with some other compilers that support the `far` qualifier). An error will be generated if `far` is applied to `auto` variables, function parameters, or function return values. This restriction does not apply to pointer-to-far as shown in the examples below.

### Example 1

```
// x is an integer variable in xmem
// y is also an integer variable in xmem
static far int x;
static int far y;

// The following is prohibited
static far int far z;
```

The exception is pointers—if a pointer to `far` is declared, as is shown in Example 2, it can be used anywhere a “normal” pointer may be used (including autos, parameters and return types). Example 2 also shows how to place a pointer in `xmem`; as with `const`, the storage qualifier comes after the “\*”, indicating that the pointer itself is in `xmem`. The pointers in the example are each 4 bytes, for the physical addresses they represent (effective 24-bit physical address—see the *Rabbit 4000 Designer’s Manual* for more information).

## Example 2

```
// x is an integer variable in xmem
// ptr_to_x is a pointer in root to an integer in xmem (pointer to far)
// far_ptr_to_x is a pointer in xmem to an integer in xmem

static far int x;
static far int * ptr_to_x = &x;
static far int * far_ptr_to_x = &x;

// The following are allowed
far int * foo(){ ... } // Returns pointer to far
void foo (far int * px) { ... } // Takes pointer-to-far as a parameter
auto far int *x; // 4 byte pointer-to-far on stack

// The following are prohibited
far int foo(){ ... }
void foo (far int x) { ... }
auto far int x;
```

You can also declare a pointer variable in xmem to a near (logical) address, as shown in [Example 3](#). The size of this pointer variable is 2 bytes – for the 16-bit logical address it represents, but the pointer itself is in xmem.

## Example 3

```
// x is a variable in root (may be auto or static)
// px, a pointer variable in xmem, points to an integer variable in root; px must be global or static
int x;
static int * far px = &x;
```

The far qualifier can also be used to put structures and arrays directly in xmem. In [Example 4](#), we have a structure defined, and followed by a declaration. The declaration uses the far qualifier to place the entire structure in xmem. Also note that “far” is not allowed for individual structure members since this does not make any sense. However, as in the case of function parameters and auto variables, pointers to far are allowed (see [Example 4](#)). Note that arrays in xmem can be made much larger than root arrays and can be indexed using long values in addition to integers.

## Example 4

```
struct rec {
 int a;
 char b[10];
 far int *p; // This is allowed

 // far int c; // This is not allowed
 // int * far np; // This is also not allowed
};

// myrec is a struct in xmem
far struct rec myrec;

// array is an array of integers in xmem
far int array[4000];
```

The far qualifier can be used in typedefs as well. In [Example 5](#), we declare a typedef for a pointer-to-far type, which can be further modified as shown.

## Example 5

```
// fptr is a pointer to an integer in xmem
typedef far int * far_ptr_to_int;
far_ptr_to_int fptr = &i;

// cptr is a pointer to an integer in xmem
typedef int * ptr_to_int;
far ptr_to_int cptr = &i;

// this declaration is equivalent to the previous two
far int * cptr = &i;
```

The keyword `far` can also be used in conjunction with `const`, allowing variables to be declared in the xmem space in flash. [Example 6](#) shows an example declaration of a far constant.

## Example 6

```
// c is a constant integer variable stored in xmem on the flash device
const far int cptr = 0x1234;
```

**NOTE:** The default storage class is `auto`, so any of the above code not explicitly marked as `static` or `auto` (and not a pointer to `far`) would have to be outside of a function or would have to be explicitly set to `static`.

---

---

## firsttime

---

---

The keyword `firsttime` in front of a function body declares the function to have an implicit `*CoData` parameter as the first parameter. This parameter should not be specified in the call or the prototype, but only in the function body parameter list. The compiler generates the code to automatically pass the pointer to the `CoData` structure associated with the costatement from which the call is made. A `firsttime` function can only be called from inside of a costatement, cofunction, or slice statement. The `DelayTick` function from `COSTATE.LIB` below is an example of a `firsttime` function.

```
firsttime nodebug int DelayTicks(CoData *pfb, unsigned int ticks)
{
 if(ticks==0) return 1;
 if(pfb->firsttime){
 fb->firsttime=0;
 /* save current ticker */
 fb->content.ul=(unsigned long)TICK_TIMER;
 }
 else if (TICK_TIMER - pfb->content.ul >= ticks)
 return 1;
 return 0;
}
```

---

---

## float

---

---

Declares variables, function return values, or arrays, as 32-bit IEEE floating point.

```
int func(){
 float x, y, *p;
 float PI = 3.14159265;
 ...
}
float func(float par){
 ...
}
```

---

---

## for

---

---

Indicates the beginning of a `for` loop. A `for` loop has an initializing expression, a limiting expression, and a stepping expression. Each expression can be empty.

```
for(;;) { // an endless loop
 ...
}
for(i = 0; i < n; i++) { // counting loop
 ...
}
```

---

---

## goto

---

---

Causes a program to go to a labeled section of code.

```
...
 if(condition) goto RED;
...
RED:
```

Use `goto` to jump forward or backward in a program. Never use `goto` to jump *into* a loop body or a switch case. The results are unpredictable. However, it is possible to jump *out of* a loop body or switch case.

---

---

## if

---

---

Indicates the beginning of an `if` statement.

```
if(tank_full) shut_off_water();
if(expression){
 statements
}else if(expression){
 statements
}else if(expression){
 statements
}else if(expression){
 statements
}...
}else{
 statements
}
```

If one of the expressions is true (they are evaluated in order), the statements controlled by that expression are executed. An `if` statement can have zero or more `else if` parts. The `else` is optional and executes only when none of the `if` or `else if` expressions are true (non-zero).

---

---

## **.init\_on**

---

---

The costatement is initially on and will automatically execute the first time it is encountered in the execution thread. The costatement becomes inactive after it completes (or aborts).

---

---

## **int**

---

---

Declares variables, function return values, or array elements to be 16-bit integers. If nothing else is specified, `int` implies a 16-bit *signed* integer.

```
int i, j, *k; // 16-bit signed
unsigned int x; // 16-bit unsigned
long int z; // 32-bit signed
unsigned long int w; // 32-bit unsigned
int funct (int arg){
 ...
}
```

---

---

## **interrupt**

---

---

Indicates that a function is an interrupt service routine (ISR). All registers, including alternates, are saved when an interrupt function is called and restored when the interrupt function returns. Writing ISRs in C is *never* recommended, especially when timing is critical.

```
interrupt isr (){
 ...
}
```

An interrupt service routine returns no value and takes no arguments.

---

---

## **\_\_lcall\_\_**

---

---

When used in a function definition, the `__lcall__` function prefix forces long call and return (`lcall` and `lret`) instructions to be generated for that function, even if the function is in root. This allows root functions to be safely called from `xmem`. In addition to root functions, this prefix also works with function pointers. The `__lcall__` prefix works safely with `xmem` functions, but has no effect on code generation. Its use with cofunctions is prohibited and will generate an error if attempted.

```
root __lcall__ int foo(void) {
 return 10; // Generates an lret instruction, even though we are in root
}
main() {
 foo(); // This now generates an lcall instruction
}
```

---

---

## long

---

---

Declares variables, function return values, or array elements to be 32-bit integers. If nothing else is specified, `long` implies a signed integer.

```
long i, j, *k; // 32-bit signed
unsigned long int w; // 32-bit unsigned
long funct (long arg){
 ...
}
```

---

---

## main

---

---

Identifies the `main` function. All programs start at the beginning of the `main` function. (`main` is actually not a keyword, but is a function name.)

---

---

## nodebug

---

---

Indicates a function is not compiled in debug mode. This is the default for assembly blocks.

```
nodebug int func(){
 ...
}
#asm nodebug
 ...
#endasm
```

See also “[debug](#)” and directives “[#debug](#) [#nodebug](#)”.

---

---

## **norst**

---

---

Indicates that a function does not use the RST instruction for breakpoints.

```
norst void func(){
 ...
}
```

The `norst` keyword in combination with the `debug` keyword will give you run-time checking without `debug`. For example,

```
debug norst foo() {
}
```

will perform runtime-checking if enabled, but will not have `rst` instructions.

---

---

## **nouseix**

---

---

Indicates a function does not use the IX register as a stack frame reference pointer. This is the default case.

```
nouseix void func(){
 ...
}
```

---

---

## **NULL**

---

---

The null pointer. (This is actually a macro, not a keyword.) Same as `(void *)0`.

---

---

## protected

---

---

An important feature of Dynamic C is the ability to declare variables as protected. Such a variable is protected against loss in case of a power failure or other system reset because the compiler generates code that creates a backup copy of a protected variable before the variable is modified. If the system resets while the protected variable is being modified, the variable's value can be restored when the system restarts. This operation requires battery-backed RAM and the use of the main system clock. If you are using the 32 kHz clock you must switch back to the main system clock to use protected variables because the atomicity of the write cannot be ensured when using the 32 kHz clock.

```
main(){
 protected int state1, state2, state3;
 ...
 _sysIsSoftReset(); // restore any protected variables
}
```

The call to `_sysIsSoftReset` checks to see if the previous board reset was due to the compiler restarting the program (i.e., a soft reset). If so, then it initializes the protected variable flags and calls `sysResetChain()`, a function chain that can be used to initialize any protected variables or do other initialization. If the reset was due to a power failure or watchdog time-out, then any protected variables that were being written when the reset occurred are restored.

A system that shares data among different tasks or among interrupt routines can find its shared data corrupted if an interrupt occurs in the middle of a write to a multi-byte variable (such as type `int` or `float`). The variable might be only partially written at its next use. Declaring a multi-byte variable *shared* means that changes to the variable are atomic, i.e., interrupts are disabled while the variable is being changed. You may declare a multi-byte variable as both *shared* and *protected*.

---

---

## register

---

---

The `register` keyword is not currently implemented in Dynamic C, but is reserved for possible future implementation. It is currently synonymous with the keyword `auto`.

---

---

## return

---

---

Explicit return from a function. For functions that return values, this will return the function result.

```
void func (){
 ...
 if(expression) return;
 ...
}
float func (int x){
 ...
 float temp;
 ...
 return (temp * 10 + 1);
}
```

---

---

## root

---

---

Indicates a function is to be placed in root memory. This keyword is semantically meaningful in function prototypes and produces more efficient code when used. Its use must be consistent between the prototype and the function definition.

```
root int func(){
 ...
}
#memmap root
#asm root
...
#endasm
```

---

---

## scofunc

---

---

Indicates the beginning of a single-user cofunction. See [cofunc on page 200](#).

---

---

## segchain

---

---

Identifies a function chain segment (within a function).

```
int func (int arg){
 ...
 int vec[10];
 ...
 segchain _GLOBAL_INIT{
 for(i = 0; i<10; i++){ vec[i] = 0; }
 }
 ...
}
```

This example adds a segment to the function chain `_GLOBAL_INIT`. Using `segchain` is equivalent to using the `#GLOBAL_INIT` directive. When this function chain executes, this and perhaps other segments elsewhere execute. The effect in this example is to reinitialize `vec[ ]`.

---

---

## shared

---

---

Indicates that changes to a multi-byte variable (such as a `float`) are atomic. Interrupts are disabled when the variable is being changed. Local variables cannot be shared. Note that you must be running off the main system clock to use shared variables. This is because the atomicity of the write cannot be ensured when running off the 32 kHz clock.

```
shared float x, y, z;
shared int j;
...
main(){
 ...
}
```

If `i` is a shared variable, expressions of the form `i++` (or `i = i + 1`) constitute *two* atomic references to variable `i`, a read and a write. Be careful because `i++` is not an atomic operation.

---

---

## short

---

---

Declares that a variable or array is short integer (16 bits). If nothing else is specified, `short` implies a 16-bit *signed* integer.

```
short i, j, *k; // 16-bit, signed
unsigned short int w; // 16-bit, unsigned
short funct (short arg){
 ...
}
```

---

---

## size

---

---

Declares a function to be optimized for size (as opposed to speed).

```
size int func (){
 ...
}
```

---

---

## signed

---

---

Declares a variable or array to be signed. If nothing else is specified in a declaration, signed means 16-bit signed integer.

```
signed char c; // 8-bit, signed
signed i, j, *k; // 16-bit, signed
signed int x; // 16-bit, signed
signed long w; // 32-bit, signed
signed funct (signed arg){
 ...
}
```

Values in a 16-bit signed integer range from -32768 to +32767 instead of 0 to 65,535. Values in a signed long integer range from  $-2^{31}$  to  $2^{31} - 1$ .

---

---

## sizeof

---

---

A built-in function that returns the size in bytes of a variable, array, structure, union, or of a data type. `sizeof()` can be used inside of assembly blocks.

```
int list[] = { 10, 99, 33, 2, -7, 63, 217 };
...
x = sizeof(list); // x will be assigned 14
```

---

---

## speed

---

---

Declares a function to be optimized for speed (as opposed to size).

```
speed int func (){
 ...
}
```

---

---

## static

---

---

Declares a local variable to have a permanent fixed location in memory, as opposed to `auto`, where the variable exists on the system stack. Global variables are by definition `static`. Local variables are `auto` by default.

```
int func (){
 ...
 int i; // auto by default
 static float x; // explicitly static
 ...
}
```

---

---

## struct

---

---

This keyword introduces a structure declaration, which defines a type.

```
struct {
 ...
 int x;
 int y;
 int z;
} thing1; // defines the variable thing1 to be a struct

struct speed{
 int x;
 int y;
 int z;
}; // declares a struct type named speed

struct speed thing2; // defines variable thing2 to be of type speed
```

Structure declarations can be nested.

```
struct {
 struct speed slow;
 struct speed slower;
} tortoise; // defines the variable tortoise to be a nested struct

struct rabbit {
 struct speed fast;
 struct speed faster;
}; // declares a nested struct type named rabbit

struct rabbit chips; // defines the variable chips to be of type rabbit
```

---

---

## switch

---

---

Indicates the start of a switch statement.

```
switch(expression){
 case const1:
 ...
 break;
 case const2:
 ...
 break;
 case const3:
 ...
 break;
 default :
 ...
}
```

The switch statement may contain any number of cases. The constants of the case statements are compared with *expression*. If there is a match, the statements for that case execute. The default case, if it is present, executes if none of the constants of the case statements match *expression*.

If the statements for a case do not include a break, return, continue, or some means of exiting the switch statement, the cases following the selected case will also execute, regardless of whether their constants match the switch expression.

---

---

## typedef

---

---

This keyword provides a way to create new names for existing data types.

```
typedef struct {
 int x;
 int y;
} xyz; // defines a struct type...

xyz thing; // ...and a thing of type xyz

typedef uint node; // meaningful type name
node master, slave1, slave2;
```

---

---

## union

---

---

Identifies a variable that can contain objects of different types and sizes at different times. Items in a union have the same address. The size of a union is that of its largest member.

```
union {
 int x;
 float y;
} abc; // overlays a float and an int
```

---

---

## unsigned

---

---

Declares a variable or array to be unsigned. If nothing else is specified in a declaration, unsigned means 16-bit unsigned integer.

```
unsigned i, j, *k; // 16-bit, unsigned
unsigned int x; // 16-bit, unsigned
unsigned long w; // 32-bit, unsigned
unsigned funct (unsigned arg){
 ...
}
```

Values in a 16-bit unsigned integer range from 0 to 65,535 instead of  $-32768$  to  $+32767$ . Values in an unsigned long integer range from 0 to  $2^{32} - 1$ .

---

---

## useix

---

---

Indicates that a function uses the IX register as a stack frame pointer.

```
useix void func(){
 ...
}
```

See also “[nouseix](#)” and directives “[#useix](#) [#nouseix](#)”.

---

---

## waitfor

---

---

Used in a costatement or cofunction, this keyword identifies a point of suspension pending the outcome of a condition, completion of an event, or some other delay.

```
for(;;){
 costate {
 waitfor (input(1) == HIGH);
 ...
 }
 ...
}
```

---

---

## waitfordone (wfd)

---

---

The `waitfordone` keyword can be abbreviated as `wfd`. It is part of Dynamic C's cooperative multitasking constructs. Used inside a costatement or a cofunction, it executes cofunctions and `firsttime` functions. When all the cofunctions and `firsttime` functions in the `wfd` statement are complete, or one of them aborts, execution proceeds to the statement following `wfd`. Otherwise a jump is made to the ending brace of the costatement or cofunction where the `wfd` statement appears; when the execution thread comes around again, control is given back to the `wfd` statement.

The `wfd` statements below are from `Samples\cofunc\cofterm.c`

```
x = wfd login(); // wfd with one cofunction

wfd { // wfd with several cofunctions
 clrscr();
 putat(5,5,"name:");
 putat(5,6,"password:");
 echoon();
}
```

`wfd` may return a value. In the example above, the variable `x` is set to 1 if `login()` completes execution normally and set to -1 if it aborts. This scheme is extended when there are multiple cofunctions inside the `wfd`: if no abort has taken place in any cofunction, `wfd` returns 1, 2, ..., `n` to indicate which cofunction inside the braces finished executing last. If an abort takes place, `wfd` returns -1, -2, ..., -`n` to indicate which cofunction caused the abort.

---

---

## while

---

---

Identifies the beginning of a `while` loop. A `while` loop tests at the beginning and may execute zero or more times.

```
while(expression){
 ...
}
```

---

---

## xdata

---

---

Declares a block of data in extended flash memory.

```
xdata name { value_1, ... value_n };
```

The 20-bit physical address of the block is assigned to `name` by the compiler as an unsigned long variable. The amount of memory allocated depends on the data type. Each `char` is allocated one byte, and each `int` is allocated two bytes. If an integer fits into one byte, it is still allocated two bytes. Each `float` and `long` cause four bytes to be allocated.

The value list may include constant expressions of type `int`, `float`, `unsigned int`, `long`, `unsigned long`, `char`, and (quoted) strings. For example:

```
xdata name1 { '\x46', '\x47', '\x48', '\x49', '\x4A', '\x20', '\x20' };
xdata name2 { 'R', 'a', 'b', 'b', 'i', 't' };
xdata name3 { " Rules! " };
xdata name4 { 1.0, 2.0, (float)3, 40e-01, 5e00, .6e1 };
```

The data can be viewed directly in the dump window by doing a physical memory dump using the 20-bit address of the `xdata` block. See `Samples\Xmem\xdata.c` for more information.

---

---

## xmem

---

---

Indicates that a function is to be placed in extended memory. This keyword is semantically meaningful in function prototypes. Good programming style dictates its use be consistent between the prototype and the function definition. That is, if a function is defined as:

```
xmem int func() {}
```

the function prototype should be:

```
xmem int func();
```

Any of the following will put the function in xmem:

```
xmem int func();
xmem int func() {}
```

or

```
xmem int func();
int func() {}
```

or

```
int func();
xmem int func() {}
```

In addition to flagging individual functions, the xmem keyword can be used with the compiler directive #memmap to send all functions not declared as root to extended memory.

```
#memmap xmem
```

This construct is helpful if an application does not have enough root code space. Another strategy is to use separate I&D space. Note that using both #memmap xmem and separate I&D space might cause an application to run out of xmem, depending on the size of the application and the size of the flash. If this occurs, the programmer should consider using only one of the #memmap xmem or separate I&D space options. If the application is extremely tight for xmem code memory but has root code memory to spare, the programmer may also consider explicitly tagging some xmem or anymem functions with the root keyword.

---

---

## void

---

---

This keyword conforms to ANSI C. Thus, it can be used in three different ways.

1. Parameter List - used to identify an empty parameter list (a.k.a., argument list). An empty parameter list can also be identified by having nothing in it. The following two statements are functionally identical:

```
int functionName(void);
int functionName();
```

2. Pointer to Void - used to declare a pointer that points to something that has no type.

```
void *ptr_to_anything;
```

3. Return Type - used to state that no value is returned.

```
void functionName(param1, param2);
```

---

---

## **volatile**

---

---

Reserved for future use.

---

---

## **xstring**

---

---

Declares a table of strings in extended memory. The strings are allocated in flash memory at compile time which means they can not be rewritten directly.

The table entries are 20-bit physical addresses. The name of the table represents the 20-bit physical address of the table; this address is assigned to name by the compiler.

```
xstring name { "string_1", . . . "string_n" };
```

---

---

## **yield**

---

---

Used in a costatement, this keyword causes the costatement to pause temporarily, allowing other costatements to execute. The `yield` statement does not alter program logic, but merely postpones it.

```
for(;;){
 costate {
 ...
 yield;
 ...
 }
 ...
}
```

## 14.1 Compiler Directives

Compiler directives are special keywords prefixed with the symbol #. They tell the compiler how to proceed. Only one directive per line is allowed, but a directive may span more than one line if a backslash (\) is placed at the end of the line(s).

There are some compiler directives used to decide where to place code and data in memory. They are called origin directives and include #rcodorg, #rvarorg and #xcodorg. A detailed description of origin directives may be found in the *Rabbit 4000 Designer's Handbook* (look in the index under “origin directives”).

---

---

### #asm

---

---

**Syntax:** #asm *options*

Begins a block of assembly code. The available options are:

- `const`: When separate I&D space is enabled, assembly constants should be placed in their own assembly block (or done in C). For more information, see Section 13.2.2, “Defining Constants.”
- `debug`: Enables debug code during assembly.
- `nodebug`: Disables debug code during assembly. This is the default condition. It is still possible to single step through assembly code as long as the assembly window is open.
- `xmem`: Places a block of code into extended memory, overriding any previous memory directives. The block is limited to 4KB.

If the #asm block is unmarked, it will be compiled to root.

---

---

### #class

---

---

**Syntax:** #class *options*

Controls the storage class for local variables. The available options are:

- `auto`: Place local variables on the stack.
- `static`: Place local variables in permanent, fixed storage. This option was deprecated in Dynamic C 10.44. The keyword “static” is still available to apply the static storage class to variables.

The default storage class is `auto`.

---

---

## #debug #nodebug

---

---

Enables or disables debug code compilation. #debug is the default condition. A function's local debug or nodebug keyword overrides the global #debug or #nodebug directive. In other words, if a function does *not* have a local debug or nodebug keyword, the #debug or #nodebug directive would apply.

#nodebug prevents RST 28h instructions from being inserted between C statements and assembly instructions.

**NOTE:** These directives do nothing if they are inside of a function. This is by design. They are meant to be used at the top of an application file.

---

---

## #define

---

---

**Syntax:** #define *name text* or #define *name (parameters . . . ) text*

Defines a macro with or without parameters according to ANSI standard. A macro without parameters may be considered a symbolic constant. Supports the # and ## macro operators. Macros can have up to 32 parameters and can be nested to 126 levels.

---

---

## #endasm

---

---

Ends a block of assembly code.

---

---

## #error

---

---

**Syntax:** #error "..."

Instructs the compiler to act as if an error was issued. The string in quotes following the directive is the message to be printed.

---

---

## #fatal

---

---

**Syntax:** #fatal “...”

Instructs the compiler to act as if a fatal error occurred. The string in quotes following the directive is the message to be printed.

---

---

## #funcchain

---

---

**Syntax:** #funcchain *chainname name*

Adds a function, or another function chain, to a function chain.

---

---

## #GLOBAL\_INIT

---

---

**Syntax:** #GLOBAL\_INIT { *variables* }

#GLOBAL\_INIT sections are blocks of code that are run once before `main()` is called. They should appear in functions after variable declarations and before the first executable code. If a local static variable must be initialized once only before the program runs, it should be done in a #GLOBAL\_INIT section, but other initialization may also be done. For example:

```
// This function outputs and returns the number of times it has been called.
int foo(){
 char count;
 #GLOBAL_INIT{
 // initialize count
 count = 1;

 // make port A output
 WrPortI(SPCR,SPCRShadow,0x84);
 }
 // output count
 WrPortI(PADR,NULL,count);

 // increment and return count
 return ++count;
}
```

---

---

**#if**  
**#elif**  
**#else**  
**#endif**

---

---

**Syntax:** `#if constant_expression`  
`#elif constant_expression`  
`#else`  
`#endif`

These directives control conditional compilation. Combined, they form a multiple-choice `if`. When the condition of one of the choices is met, the Dynamic C code selected by the choice is compiled. Code belonging to the other choices is ignored.

```
main(){
 #if BOARD_TYPE == 1
 #define product "Ferrari"
 #elif BOARD_TYPE == 2
 #define product "Maserati"
 #elif BOARD_TYPE == 3
 #define product "Lamborghini"
 #else
 #define product "Chevy"
 #endif
 ...
}
```

The `#elif` and `#else` directives are optional. Any code between an `#else` and an `#endif` is compiled if all values for `constant_expression` are false.

---

---

**#ifdef**

---

---

**Syntax:** `#ifdef name`

This directive enables code compilation if `name` has been defined with a `#define` directive. This directive must have a matching `#endif`.

---

---

## #ifndef

---

---

**Syntax:** `#ifndef name`

This directive enables code compilation if *name* has not been defined with a `#define` directive. This directive must have a matching `#endif`.

---

---

## #include

---

---

**Syntax:** `#include "pathname"` or `#include <pathname>`

Inserts the file specified by "pathname" into the code. This is a straight textual insertion as if the contents of the file were cut and pasted directly into the file at the location of the `#include` directive.

The two versions allow for control over which include paths are searched. The double-quotes ("pathname") around the path cause the compiler to first search in the directory where the source file containing the `#include` is located, then move on to the include path list provided by the GUI or project file. The angle brackets (<pathname>) version skips the initial path and searches just the include paths list.

---

---

## #interleave #nointerleave

---

---

Controls whether Dynamic C will intersperse library functions with the program's functions during compilation.

`#nointerleave` forces the user-written functions to be compiled first. The `#nointerleave` directive, when placed at the top of application code, tells Dynamic C to compile all of the application code first and then to compile library code called by the application code afterward, and then to compile other library code called by the initial library code following that, and so on until finished.

Note that the `#nointerleave` directive can be placed anywhere in source code, with the effect of stopping interleaved compilation of functions from that point on. If `#nointerleave` is placed in library code, it will effectively cause the user-written functions to be compiled together starting at the statement following the library call that invoked `#nointerleave`.

---

---

## #makechain

---

---

**Syntax:** #makechain *chainname*

Creates a function chain. When a program executes the function chain named in this directive, all of the functions or segments belonging to the function chain execute.

---

---

## #memmap

---

---

**Syntax:** #memmap *options*

Controls the default memory area for functions. The following options are available.

- **anymem NNNN:** When code comes within NNNN bytes of the end of root code space, start putting it in `xmem`. Default memory usage is `#memmap anymem 0x2000`.
- **root:** All functions not declared as `xmem` go to root memory.
- **xmem:** C functions not declared as `root` go to extended memory. Assembly blocks not marked as `xmem` go to root memory. See the description for `xmem` for more information on this keyword.

---

---

## #pragma

---

---

**Syntax:** #pragma nowarn [*warnt*|*warns*]

Trivial warnings (*warnt*) or trivial and serious warnings (*warns*) for the next physical line of code are not displayed in the Compiler Messages window. The argument is optional; default behavior is *warnt*.

**Syntax:** #pragma nowarn [*warnt*|*warns*] *start*

Trivial warnings (*warnt*) or trivial and serious warnings (*warns*) are not displayed in the Compiler Messages window until the `#pragma nowarn end` statement is encountered. The argument is optional; default behavior is *warnt*. `#pragma nowarn` cannot be nested.

---

---

## #undef

---

---

**Syntax:** #undef *identifier*

Removes (undefines) a defined macro.

---

---

## #use

---

---

**Syntax:** #use *pathname*

Activates a library named in LIB.DIR so modules in the library can be linked with the application program. This directive immediately reads in all the headers in the library unless they have already been read.

See [Section 4.8.1 “Libraries and File Scope”](#) for a description of how #use interacts with file scoping (introduced in Dynamic C 10.64).

---

---

## #useix #nouseix

---

---

Controls whether functions use the IX register as a stack frame reference pointer or the SP (stack pointer) register. #nouseix is the default.

Note that when the IX register is used as a stack frame reference pointer, it is corrupted when any stack-variable using function is called from within a cofunction, or if a stack-variable using function contains a call to a cofunction.

---

---

## #warns

---

---

**Syntax:** #warns “...”

Instructs the compiler to act as if a serious warning was issued. The string in quotes following the directive is the message to be printed.

---

---

## #warnt

---

---

**Syntax:** #warnt “...”

Instructs the compiler to act as if a trivial warning was issued. The string in quotes following the directive is the message to be printed.

---

---

## #ximport

---

---

**Syntax:** #ximport "*filename*" *symbol*

This compiler directive places the length of *filename* (stored as a long) and its binary contents at the next available place in xmem flash. *filename* is assumed to be either relative to the Dynamic C installation directory or a fully qualified path. *symbol* is a compiler generated macro that gives the physical address where the length and contents were stored.

The sample program `ximport.c` illustrates the use of this compiler directive.

---

---

## #zimport

---

---

**Syntax:** #zimport "*filename*" *symbol*

This compiler directive extends the functionality of #ximport to include file compression by an external utility. *filename* is the input file (and must be relative to the Dynamic C installation directory or be a fully qualified path) and *symbol* represents the 20-bit physical address of the downloaded file.

The external utility supplied with Dynamic C is `zcompress.exe`. It outputs the compressed file to the same directory as the input file, appending the extension `.DCZ`. E.g., if the input file is named `test.txt`, the output file will be named `test.txt.dcz`. The first 32 bits of the output file contains the length (in bytes) of the file, followed by its binary contents. The most significant bit of the length is set to one to indicate that the file is compressed.

The sample program `zimport.c` illustrates the use of this compiler directive. Please see [Appendix C.0.3](#) for further information regarding file compression and decompression.

# 15. OPERATORS

An operator is a symbol such as +, −, or & that expresses some kind of operation on data. Most operators are binary—they have two operands.

```
a + 10 // two operands with binary operator "add"
```

Some operators are unary—they have a single operand,

```
-amount // single operand with unary "minus"
```

although, like the minus sign, some unary operators can also be used for binary operations.

There are many kinds of operators with operator *precedence*. Precedence governs which operations are performed before other operations, when there is a choice.

For example, given the expression

```
a = b + c * 10;
```

will the + or the \* be performed first? Since \* has higher precedence than +, it will be performed first. The expression is equivalent to

```
a = b + (c * 10);
```

Parentheses can be used to force any order of evaluation. The expression

```
a = (b + c) * 10;
```

uses parentheses to circumvent the normal order of evaluation.

Associativity governs the execution order of operators of equal precedence. Again, parentheses can circumvent the normal associativity of operators. For example,

```
a = b + c + d; // (b+c) performed first
a = b + (c + d); // now c+d is performed first
int *a(); // function returning a pointer to an integer
int (*a)(); // pointer to a function returning an integer
```

Unary operators and assignment operators associate from right to left. Most other operators associate from left to right.

Certain operators, namely `*`, `&`, `()`, `[]`, `->` and `.` (dot), can be used on the left side of an assignment to construct what is called an *lvalue*. For example,

```
float x;
(char)&x = 0x17; // low byte of x gets value
```

When the data types for an operation are mixed, the resulting type is the more precise.

```
float x, y, z;
int i, j, k;
char c;
z = i / x; // same as (float)i / x
j = k + c; // same as k + (int)c
```

By placing a type name in parentheses in front of a variable, the program will perform type casting or type conversion. In the example above, the term `(float)i` means the “the value of `i` converted to floating point.”

The operators are summarized in the following pages.

## 15.1 Arithmetic Operators

**+**

Unary plus, or binary addition. (Standard C does not have unary plus.) Unary plus does not really do anything.

```
a = b + 10.5; // binary addition
z = +y; // just for emphasis!
```

**-**

Unary minus, or binary subtraction.

```
a = b - 10.5; // binary subtraction
z = -y; // z gets the negative of y
```

## \*

Indirection, or multiplication. As a unary operator, it indicates indirection. When used in a declaration, \* indicates that the following item is a pointer. When used as an indirection operator in an expression, \* provides the value at the address specified by a pointer.

```
int *p; // p is a pointer to an integer
int j;

j = 45;
p = &j; // p now points to j

k = *p; // k gets the value to which p points (k=45)
*p = 25; // Same as j = 25, since p points to j
```

*Beware of using uninitialized pointers.* Also, the indirection operator can be used in complex ways.

```
int *list[10] // array of 10 pointers to integers
int (*list)[10] // pointer to array of 10 integers
float** y; // pointer to a pointer to a float
z = **y; // z gets the value of y
typedef char **stp;
stp my_stuff; // my_stuff is typed char**
```

As a binary operator, the \* indicates multiplication.

```
a = b * c; // a gets the product of b and c
```

## /

Divide is a binary operator. Integer division truncates; floating-point division does not.

```
const int i = 18, const j = 7, k; float x;

k = i / j; // result is 2;
x = (float)i / j; // result is 2.591...
```

## ++

Pre- or post-increment is a unary operator designed primarily for convenience. If the ++ precedes an operand, the operand is incremented before use. If the ++ operator follows an operand, the operand is incremented after use.

```
int i, a[12];
i = 0;
q = a[i++]; // q gets a[0], then i becomes 1
r = a[i++]; // r gets a[1], then i becomes 2
s = ++i; // i becomes 3, then s = i
i++; // i becomes 4
```

If the ++ operator is used with a pointer, the value of the pointer increments by the size of the object (in bytes) to which it points. With operands other than pointers, the value increments by 1.

## --

Pre- or post-decrement. If the -- precedes an operand, the operand is decremented before use. If the -- operator follows an operand, the operand is decremented after use.

```
int j, a[12];
j = 12;
q = a[--j]; // j becomes 11, then q gets a[11]
r = a[--j]; // j becomes 10, then r gets a[10]
s = j--; // s = 10, then j becomes 9
j--; // j becomes 8
```

If the -- operator is used with a pointer, the value of the pointer decrements by the size of the object (in bytes) to which it points. With operands other than pointers, the value decrements by 1.

## %

Modulus. This is a binary operator. The result is the remainder of the left-hand operand divided by the right-hand operand.

```
const int i = 13;
j = i % 10; // j gets i mod 10 or 3
const int k = -11;
j = k % 7; // j gets k mod 7 or -4
```

## 15.2 Assignment Operators

**=**

Assignment. This binary operator causes the value of the right operand to be assigned to the left operand. Assignments can be “cascaded” as shown in this example.

```
a = 10 * b + c; // a gets the result of the calculation
a = b = 0; // b gets 0 and a gets 0
```

**+=**

Addition assignment.

```
a += 5; // Add 5 to a. Same as a = a + 5
```

**-=**

Subtraction assignment.

```
a -= 5; // Subtract 5 from a. Same as a = a - 5
```

**\*=**

Multiplication assignment.

```
a *= 5; // Multiply a by 5. Same as a = a * 5
```

**/=**

Division assignment.

```
a /= 5; // Divide a by 5. Same as a = a / 5
```

**%=**

Modulo assignment.

```
a %= 5; // a mod 5. Same as a = a % 5
```

**<<=**

Left shift assignment.

```
a <<= 5; // Shift a left 5 bits. Same as a = a << 5
```

**>>=**

Right shift assignment.

```
a >>= 5; // Shift a right 5 bits. Same as a = a >> 5
```

**&=**

Bitwise AND assignment.

```
a &= b; // AND a with b. Same as a = a & b
```

**^=**

Bitwise XOR assignment.

```
a ^= b; // XOR a with b. Same as a = a ^ b
```

**|=**

Bitwise OR assignment.

```
a |= b; // OR a with b. Same as a = a | b
```

## 15.3 Bitwise Operators

**<<**

Shift left. This is a binary operator. The result is the value of the left operand shifted by the number of bits specified by the right operand.

```
int i = 0xF00F;
j = i << 4; // j gets 0x00F0
```

The most significant bits of the operand are lost; the vacated bits become zero.

**>>**

Shift right. This is a binary operator. The result is the value of the left operand shifted by the number of bits specified by the right operand:

```
int i = 0xF00F;
j = i >> 4; // j gets 0xFF00
```

The least significant bits of the operand are lost; the vacated bits become zero for unsigned variables and are sign-extended for signed variables.

## &

Address operator, or bitwise AND. As a unary operator, this provides the address of a variable:

```
int x;
z = &x; // z gets the address of x
```

As a binary operator, this performs the bitwise AND of two integer (char, int, or long) values.

```
int i = 0xFFFF0;
int j = 0x0FFF;
z = i & j; // z gets 0x0FF0
```

## ^

Bitwise exclusive OR. A binary operator, this performs the bitwise XOR of two integer (8-bit, 16-bit or 32-bit) values.

```
int i = 0xFFFF0;
int j = 0x0FFF;
z = i ^ j; // z gets 0xF00F
```

## |

Bitwise inclusive OR. A binary operator, this performs the bitwise OR of two integer (8-bit, 16-bit or 32-bit) values.

```
int i = 0xFF00;
int j = 0x0FF0;
z = i | j; // z gets 0xFFFF0
```

## ~

Bitwise complement. This is a unary operator. Bits in a char, int, or long value are inverted:

```
int switches;
switches = 0xFFFF0;
j = ~switches; // j becomes 0x000F
```

## 15.4 Relational Operators

<

Less than. This binary (relational) operator yields a Boolean value. The result is 1 if the left operand is less than the right operand, and 0 otherwise.

```
if(i < j){
 body // executes if i < j
}
OK = a < b; // true when a < b
```

<=

Less than or equal. This binary (relational) operator yields a boolean value. The result is 1 if the left operand is less than or equal to the right operand, and 0 otherwise.

```
if(i <= j){
 body // executes if i <= j
}
OK = a <= b; // true when a <= b
```

>

Greater than. This binary (relational) operator yields a Boolean value. The result is 1 if the left operand is greater than the right operand, and 0 otherwise.

```
if(i > j){
 body // executes if i > j
}
OK = a > b; // true when a > b
```

>=

Greater than or equal. This binary (relational) operator yields a Boolean value. The result is 1 if the left operand is greater than or equal to the right operand, and 0 otherwise.

```
if(i >= j){
 body // executes if i >= j
}
OK = a >= b; // true when a >= b
```

## 15.5 Equality Operators

### ==

Equal. This binary (relational) operator yields a Boolean value. The result is 1 if the left operand equals the right operand, and 0 otherwise.

```
if(i == j){
 body // executes if i = j
}
OK = a == b; // true when a = b
```

Note that the == operator is not the same as the assignment operator (=). A common mistake is to write

```
if(i = j){
 body
}
```

Here, *i* gets the value of *j*, and the `if` condition is true when *i* is non-zero, **not** when *i* equals *j*.

### !=

Not equal. This binary (relational) operator yields a Boolean value. The result is 1 if the left operand is not equal to the right operand, and 0 otherwise.

```
if(i != j){
 body // executes if i != j
}
OK = a != b; // true when a != b
```

## 15.6 Logical Operators

**&&**

Logical AND. This is a binary operator that performs the Boolean AND of two values. If either operand is 0, the result is 0 (FALSE). Otherwise, the result is 1 (TRUE).

**||**

Logical OR. This is a binary operator that performs the Boolean OR of two values. If either operand is non-zero, the result is 1 (TRUE). Otherwise, the result is 0 (FALSE).

**!**

Logical NOT. This is a unary operator. Observe that C does not provide a Boolean data type. In C, logical false is equivalent to 0. Logical true is equivalent to non-zero. The NOT operator result is 1 if the operand is 0. The result is 0 otherwise.

```
test = get_input(...);
if(!test){
 ...
}
```

## 15.7 Postfix Expressions

**( )**

Grouping. Expressions enclosed in parentheses are performed first. Parentheses also enclose function arguments. In the expression

```
a = (b + c) * 10;
```

the term **b + c** is evaluated first.

**[ ]**

Array subscripts or dimension. All array subscripts count from 0.

```
int a[12]; //array dimension is 12
j = a[i]; //references the ith element
```

## • (dot)

The dot operator joins structure (or union) names and subnames in a reference to a structure (or union) element.

```
struct {
 int x;
 int y;
} coord;
m = coord.x;
```

## ->

Right arrow. Used with pointers to structures and unions, instead of the dot operator.

```
typedef struct{
 int x;
 int y;
} coord;

coord *p; // p is a pointer to structure

...
m = p->x; // reference to structure element
```

## 15.8 Reference/Dereference Operators

### &

Address operator, or bitwise AND. As a unary operator, this provides the address of a variable:

```
int x;
z = &x; // z gets the address of x
```

As a binary operator, this performs the bitwise AND of two integer (char, int, or long) values.

```
int i = 0xFFFF0;
int j = 0xFFFF;
z = i & j; // z gets 0x0FFF0
```

### \*

Indirection, or multiplication. As a unary operator, it indicates indirection. When used in a declaration, \* indicates that the following item is a pointer. When used as an indirection operator in an expression, \* provides the value at the address specified by a pointer.

```
int *p; // p is a pointer to an integer
int j;
j = 45;
p = &j; // p now points to j

k = *p; // k gets the value to which p points (k=45)
*p = 25; // Same as j = 25, since p points to j
```

*Beware of using uninitialized pointers.* Also, the indirection operator can be used in complex ways.

```
int *list[10] // array of 10 ptrs to int
int (*list)[10] // ptr to array of 10 ints
float** y; // ptr to a ptr to a float
z = **y; // z gets the value of y
typedef char **stp;
stp my_stuff; // my_stuff is typed char**
```

As a binary operator, the \* indicates multiplication.

```
a = b * c; // a gets the product of b and c
```

## 15.9 Conditional Operators

Conditional operators are a three-part operation unique to the C language. The operation has three operands and the two operator symbols `?` and `:`.

---

`? :`

---

If the first operand evaluates true (non-zero), then the result of the operation is the second operand. Otherwise, the result is the third operand.

```
int i, j, k;
...
i = j < k ? j : k;
```

The `? :` operator is for convenience. The above statement is equivalent to the following.

```
if(j < k)
 i = j;
else
 i = k;
```

If the second and third operands are of different type, the result of this operation is returned at the higher precision.

## 15.10 Other Operators

### (type)

The cast operator converts one data type to another. A floating-point value is truncated when converted to integer. The bit patterns of character and integer data are not changed with the cast operator, although high-order bits will be lost if the receiving value is not large enough to hold the converted value.

```
unsigned i; float x = 10.5; char c;
i = (unsigned)x; // i gets 10;
c = *(char*)&x; // c gets the low byte of x
typedef ... typeA;
typedef ... typeB;
typeA item1;
typeB item2;
...
item2 = (typeB)item1; // forces item1 to be treated as a typeB
```

### sizeof

The `sizeof` operator is a unary operator that returns the size (in bytes) of a variable, structure, array, or union. It operates at compile time as if it were a built-in function, taking an object or a type as a parameter.

```
typedef struct{
 int x;
 char y;
 float z;
} record;

record array[100];
int a, b, c, d;
char cc[] = "Fourscore and seven";
char *list[] = { "ABC", "DEFG", "HI" };

#define array_size sizeof(record)*100 // number of bytes in array
a = sizeof(record); // 7
b = array_size; // 700
c = sizeof(cc); // 20
d = sizeof(list); // 6
```

Why is `sizeof(list)` equal to 6? `list` is an array of 3 pointers (to `char`) and pointers have two bytes.

Why is `sizeof(cc)` equal to 20 and not 19? C strings have a terminating null byte appended by the compiler.

Comma operator. This operator, unique to the C language, is a convenience. It takes two operands: the left operand—typically an expression—is evaluated, producing some effect, and then discarded. The right-hand expression is then evaluated and becomes the result of the operation.

This example shows somewhat complex initialization and stepping in a `for` statement.

```
for(i=0,j=strlen(s)-1; i<j; i++,j-){
 ...
}
```

Because of the comma operator, the initialization has two parts: (1) set `i` to 0 and (2) get the length of string `s`. The stepping expression also has two parts: increment `i` and decrement `j`.

The comma operator exists to allow multiple expressions in loop or `if` conditions.

The table below shows the operator precedence, from highest to lowest. All operators grouped together have equal precedence.

**Table 15-1. Operator Precedence**

| Operators                                                                      | Associativity | Function       |
|--------------------------------------------------------------------------------|---------------|----------------|
| <code>() [] -&gt; .</code>                                                     | left to right | member         |
| <code>! ~ ++ --</code><br><code>(type) * &amp; sizeof</code>                   | right to left | unary          |
| <code>* / %</code>                                                             | left to right | multiplicative |
| <code>+ -</code>                                                               | left to right | additive       |
| <code>&lt;&lt; &gt;&gt;</code>                                                 | left to right | bitwise        |
| <code>&lt; &lt;= &gt; &gt;=</code>                                             | left to right | relational     |
| <code>== !=</code>                                                             | left to right | equality       |
| <code>&amp;</code>                                                             | left to right | bitwise        |
| <code>^</code>                                                                 | left to right | bitwise        |
| <code> </code>                                                                 | left to right | bitwise        |
| <code>&amp;&amp;</code>                                                        | left to right | logical        |
| <code>  </code>                                                                | left to right | logical        |
| <code>? :</code>                                                               | right to left | conditional    |
| <code>= *= /= %= += -=</code><br><code>&lt;&lt;= &gt;&gt;= &amp;= ^=  =</code> | right to left | assignment     |
| <code>,</code> (comma)                                                         | left to right | series         |

# 16. GRAPHICAL USER INTERFACE

Dynamic C can be used to edit source files, compile and run programs, and choose options for these activities using pull-down menus or keyboard shortcuts. There are two modes: *edit mode* and *run mode* (run mode is also known as *debug mode*). Various debugging windows can be viewed in run mode. Programs can compile directly to a target controller for debugging in RAM or Flash. Programs can also be compiled to a `.bin` file, with or without a controller connected to the PC.

To debug a program, a controller must be connected to the PC, either directly via a programming cable or indirectly via an Ethernet connection while using either a RabbitLink board or a RabbitSys-enabled board.

Multiple instances of Dynamic C can run simultaneously. This means multiple debugging sessions are possible over different serial ports. This is useful for debugging boards that are communicating among themselves.

## 16.1 The GUI Environment

### 16.1.1 Editing

A file is displayed in a text window when it is opened or created. More than one text window may be open. If the same file is in multiple windows, any changes made to the file in one window will be reflected in all text windows that display that file. Dynamic C supports normal Windows text editing operations.

A mouse (or other pointing device) may be used to position the text cursor, select text, or extend a text selection. The keyboard may be used to do these same things. Text may be scrolled using the arrow keys, the PageUp and PageDown keys, and the Home and End keys. The up, down, left and right arrow keys move the cursor in the corresponding directions.

The Home key may be used alone or with other keys.

|                 |                              |
|-----------------|------------------------------|
| Home            | Move to beginning of line.   |
| Ctrl+Home       | Move to beginning of file.   |
| Shift+Home      | Select to beginning of line. |
| Shift+Ctrl+Home | Select to beginning of file. |

The End key may be used alone or with other keys.

|                |                        |
|----------------|------------------------|
| End            | Move to end of line.   |
| Ctrl+End       | Move to end of file.   |
| Shift+End      | Select to end of line. |
| Shift+Ctrl+End | Select to end of file. |

The Ctrl key works in conjunction with the arrow keys:

|            |                                                                       |
|------------|-----------------------------------------------------------------------|
| Ctrl+Left  | Move cursor to previous word.                                         |
| Ctrl+Right | Move cursor to next word.                                             |
| Ctrl+Up    | Move editor window up, text moves down one line. Cursor is not moved. |
| Ctrl+Down  | Move editor window down, text moves up one line. Cursor is not moved. |

The Ctrl key also works in conjunction with “[” for delimiter matching. Place the cursor before the delimiter you are attempting to match and press “Ctrl+[”. The cursor will move to just before the matching delimiter.

Note that delimiters in comments are also matched. For example, in the following code, <Ctrl+[> counts commented-out braces in the matching, giving a false indication that the main function has balanced curly braces when in fact it does not.

```
main()
{
 {
 //}
 /*
 }
 */
```

## 16.1.2 Menus

Dynamic C’s main menu has eight command menus, as well as the standard Windows system menus.

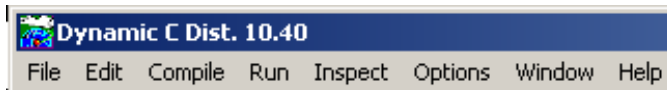

An available command can be executed from a menu by either clicking the menu and then clicking the command, or by pressing the Alt key to activate the menu bar, using the left and right arrow keys to select a menu, and then using the up or down arrow keys to select a command before pressing the Enter key.

## 16.1.3 Using Keyboard Shortcuts

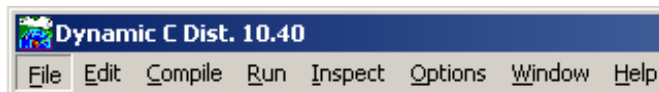

For some of us it is easier to type keyboard shortcuts than to use a mouse. A menu can be activated by pressing the Alt key while pressing the underlined letter of the menu name. This is the de facto standard, as it is used in numerous commercial software products. Pressing the Alt key allows you to see which character in the menu name is underlined, as shown in this second screenshot of Dynamic C’s main menu. All the keyboard shortcuts on the main menu use the first letter of the menu name in the shortcut. Some keyboard shortcuts have this obvious connection while others do not. See the Editor Tab screenshot in [Section 16.7](#) for some examples of not so obvious keyboard shortcuts. A keyboard shortcut that is not menu specific is the Esc key, which will make any visible menu disappear.

## 16.1.4 Editor Window Popup Menu

Right click anywhere in the editor window and a popup menu will appear. All of the menu options, with the exception of Open File at Cursor, are available from the main menu, e.g., New is an option in the File menu and was described earlier with the other options for that menu.

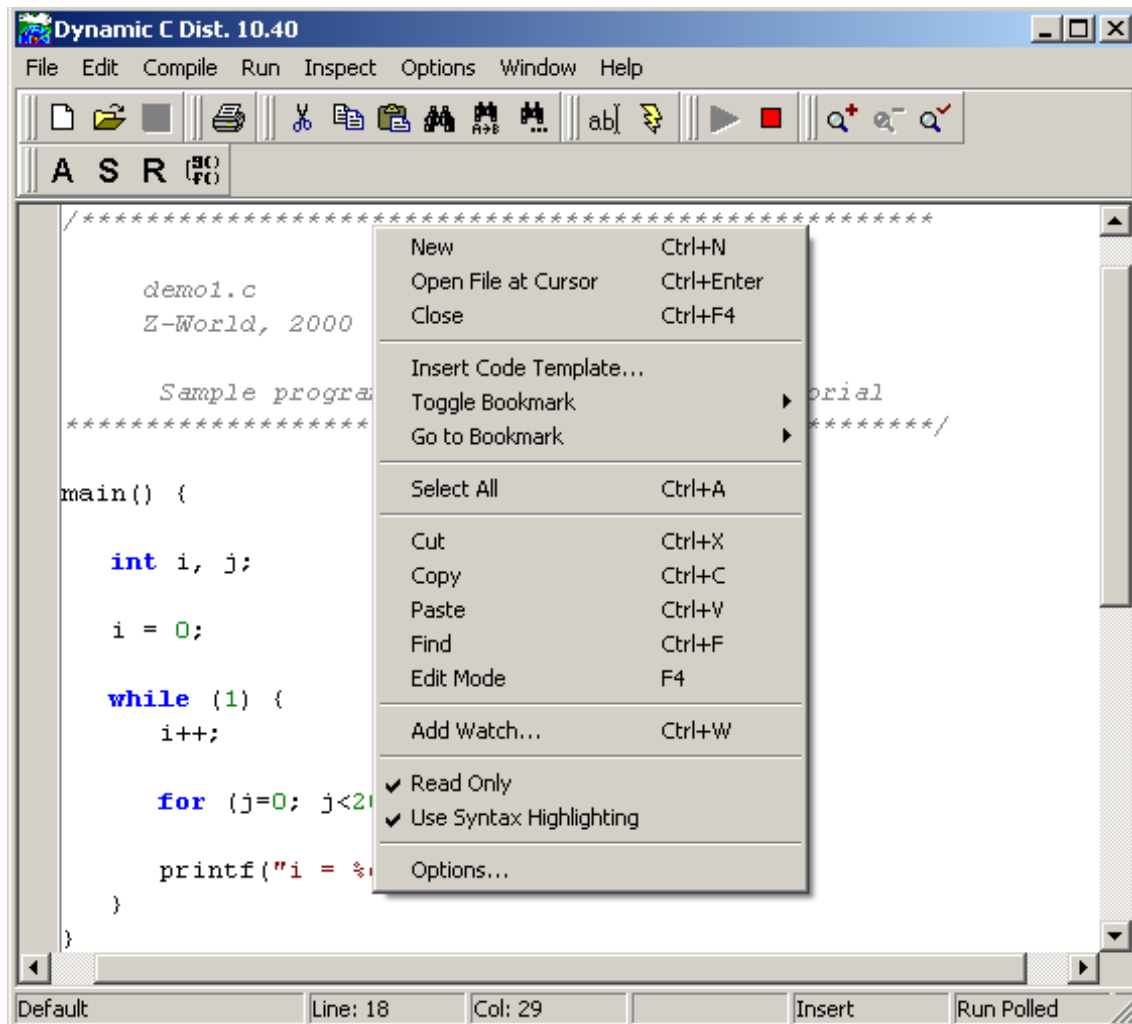

### Open File at Cursor <Ctrl+Enter>

Attempts to open the file whose name is under the cursor. The file will be opened in a new editor window, if the file name is listed in the "lib.dir" file as either an absolute path or a path relative to the Dynamic C root directory or if the file is in Dynamic C's root directory. As a last resort, an Open dialog box will appear so that the file may be manually chosen.

## 16.2 File Menu

To select the File menu: click on its name in Dynamic C's main menu or press <Alt+F>.

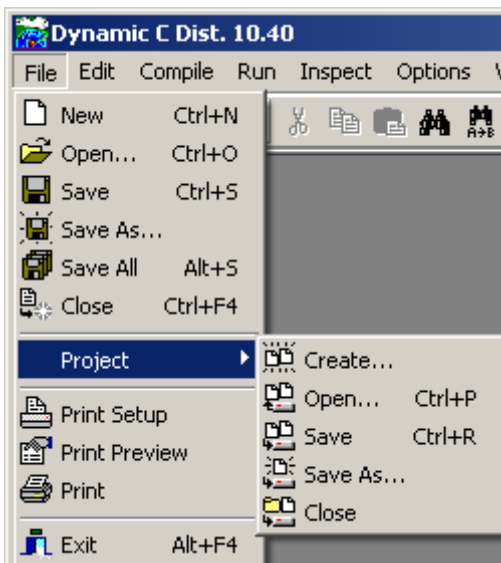

### **New <Ctrl+N>**

Creates a blank, untitled program in a new window, called the text window or the editor window. If you right click anywhere in the text window a popup menu will appear. It is available as a convenience for accessing some frequently used commands.

### **Open <Ctrl+O>**

Presents a dialog box to specify the name of a file to open. To select a file, type in the file name (pathnames may be entered), or browse and select it. Unless there is a problem, Dynamic C will present the contents of the file in a text window. The program can then be edited or compiled. Multiple files can be selected by holding down <Ctrl> then clicking the left mouse on each filename you want to open, or by dragging the selection rectangle over multiple filenames.

### **Save <Ctrl+S>**

The Save command updates an open file to reflect changes made since the last time the file was saved. If the file has not been saved before (i.e., the file is a new untitled file), the Save As dialog will appear to prompt for a name. Use the Save command often while editing to protect against loss during power failures or system crashes.

### **Save As**

Presents a dialog box to save the file under a new name. To select a file name, type it in the File name field. The file will be saved in the folder displayed in the Save in field. You may, of course, browse to another location. You may also select an existing file. Dynamic C will ask you if you wish to replace the existing file with the new one.

### **Save All <Shift+Ctrl+S>**

This command saves all modified files that are currently open.

### **Close <Ctrl+F4>**

Closes the active editor window. If there is an attempt to close a modified file, Dynamic C will ask you if you wish to save the changes. The file is saved when Yes is clicked or "y" is typed. If the file is untitled, there will be a prompt for a file name in the Save As dialog. Any changes to the document will be discarded if No is clicked or "n" is typed. Choosing Cancel results in a return to Dynamic C with no action taken.

### **Project**

Allows a project file to be created, opened, saved, saved as a different name and closed. See [Chapter 18, "Project Files."](#) for all the details on project files.

## **Print Setup**

Displays the Page Setup dialog box. Margins, page orientation, page numbers and header and footer properties are all chosen here.

The “Printer Setup” button is in the bottom left of the dialog box. It brings up the Print Setup dialog box, which allows a printer to be selected. The “Network” button allows printers to be added or removed from the list of printers.

## **Print Preview**

Displays whichever file is in the active editor window in the Preview Form window, showing how the text will look when it is printed. You can search and navigate through the printable pages and bring up the Print dialog box.

## **Print**

Brings up the Print dialog box, which allows you to choose a printer. Only text in an editor window can be printed. To print the contents of debug windows the text must be copied and pasted to an editor window. (The Stdio window is an exception; its contents may be automatically written to a file, which may then be printed.) As many copies of the text as needed may be printed. If more than one copy is requested, the pages may be collated or uncollated.

## **Exit <Alt+F4>**

Close Dynamic C after prompting to save any unsaved changes to open files.

## 16.3 Edit Menu

Click the menu title or press <Alt+E> to select the EDIT menu.

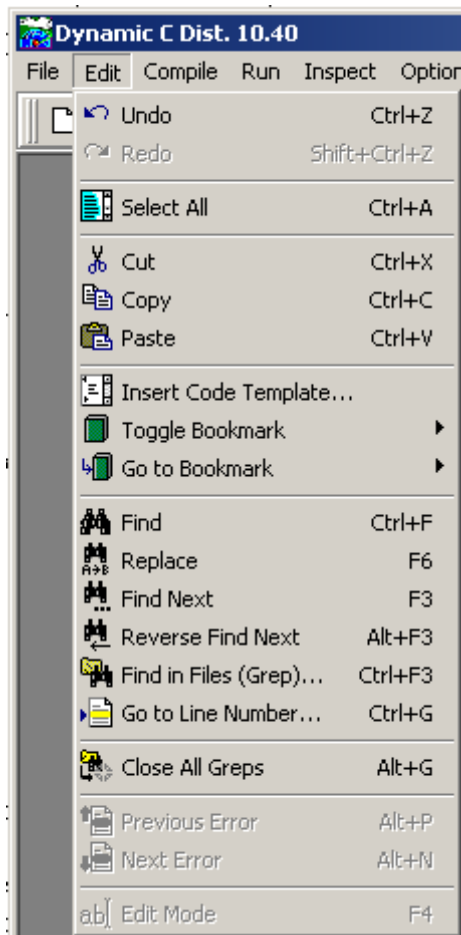

### Undo <Ctrl+Z>

This option undoes recent changes in the active edit window. The command may be repeated several times to undo multiple changes. Undo operations have unlimited depth. Two types of undo are supported—applied to a single operation and applied to a group of the same operations (2 continuous deletes are considered a single operation).

Dynamic C only discards undo information if the “Undo after save” option is unchecked in the Editor dialog under Environment Options.

### Redo <Shift+Ctrl+Z>

Redoes changes recently undone. This command only works immediately after one or more Undo operations.

### Select All <Ctrl+A>

The keyboard shortcut <Ctrl+A> no longer clears all breakpoints. Starting with Dynamic C 10.21, this shortcut selects all text in the active window. “Select All” works in the following windows: Editor, Stdio, Message, Disassembly, Registers, Stack, Watch, Stack Tracing, Grep Results and Function Description.

### Cut <Ctrl+X>

Removes selected text and saves to the clipboard.

### Copy <Ctrl+C>

Makes a copy of text selected in a file or in a debug window. The text is saved on the clipboard.

### Paste <Ctrl+V>

Pastes text from the clipboard to the current insertion point. Nothing can be pasted in a debugging window. The contents of the clipboard may be pasted virtually anywhere, repeatedly (as long as nothing new is cut or copied into the clipboard), in the same or other source files, or even in word processing or graphics program documents.

### Insert Code Template <Ctrl+J>

Opens the code template list at the current cursor location. Clicking on a list entry or pressing <Enter> inserts the selected template at the cursor location in the active edit window. The arrow keys may be used to scroll the list. Pressing the first letter of the name of a code template selects the first template whose name starts with that letter. Pressing the same letter again will go to the next template whose name starts with that letter. Continuing to press the same letter cycles through all the templates whose name starts with that letter.

To create, edit or remove templates from the code template list, go to Environment Options and click on the Code Templates tab.

### Toggle Bookmark

Toggle one of ten bookmarks in the active edit window.

## **Go to Bookmark**

Go to one of ten bookmarks in the active edit window. Executing this command again will take you back to the location you were at before going to the bookmarked location.

## **Find** <Ctrl F>

Finds first occurrence of specified text. Text may be specified by selecting it prior to opening the Find dialog box if the option “Find text at cursor” is checked in the Editor dialog under Environment Options. Only one word may be selected; if more than one word is selected, the last word selected appears as the entry for the search text. More than one word of text may be specified by typing it in or selecting it from the available history of search text.

There are several ways to narrow or broaden the search criteria using the Find dialog box. For example, if Case sensitive is unchecked, then “Switch” and “SWITCH” would match the search text “switch.” If Whole words only is checked, then the search text “switch” would not match “switches.” Selecting Entire scope will cause the whole document to be searched. If Selected text is chosen and the Persistent blocks option was checked in the Editor tab in Environment Options, the search will take place only in the selected text.

## **Replace** <F6>

Finds and replaces the specified text. Text may be specified by selecting it prior to opening the Replace Text dialog box. Only one word may be selected; if more than one word is selected, the last word selected appears as the entry for the search text. More than one word of text may be specified by typing it in or selecting it from the available history of search text. The replacement text is typed or selected from the available history of replacement text.

As with the Find dialog box, there are several ways to narrow or broaden the search criteria. An important option is Prompt on replace. If this is unchecked, Dynamic C will not prompt before making the replacement, which could be dangerous in combination with the choice to Replace All.

## **Find Next** <F3>

Once search text has been specified with the Find or Replace commands, the Find Next command will find the next occurrence of the same text, searching forward or in reverse, case sensitive or not, as specified with the previous Find or Replace command. If the previous command was Replace, the operation will be a replace.

## **Reverse Find Next** <Alt+F3>

Behaves the same as Find Next except in the opposite direction. If Find Next is searching forward in the file, Reverse Find Next will search backwards, and vice versa.

### Find in Files (Grep)... <Shift+Ctrl+F>

This option searches for text in the currently open file(s) or in any directory (optionally including sub-directories) specified. Standard Unix-style regular expressions are used.

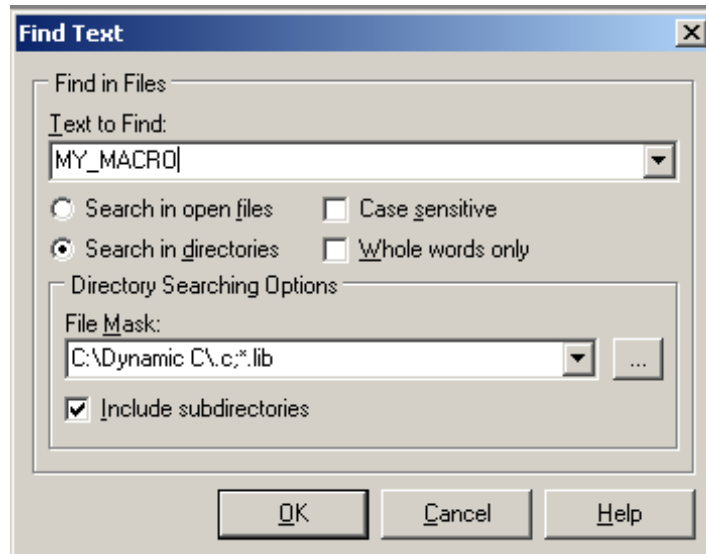

A window with the search results is displayed with an entry for each match found. Double-clicking on an entry will open the corresponding file and place the cursor on the search string in that file. Multiple file types can be separated by semicolons. For example, entering `C:\mydirectory\*.lib;*.c` will search all `.lib` and `.c` files in `mydirectory`.

The “Search Results” window has a right-click menu. Dynamic C 10.21 introduces two options in this menu: the ability to select all text in the window <Ctrl+A> and the ability to delete any text selected in the window.

### Go to Line Number

Positions the insertion point at the beginning of the specified line.

### Close all GREPS <Alt+G>

Closes all open GREP Search Results windows.

### Previous Error <Ctrl+Alt+P>

Locates the previous compilation error in the source code. Any error messages will be displayed in a list in the Compiler Messages window after a program is compiled. Dynamic C selects the previous error in the list and displays the offending line of code in the text window.

### Next Error <Ctrl+Alt+N>

Locates the next compilation error in the source code. Any error messages will be displayed in a list in the Compiler Messages window after a program is compiled. Dynamic C selects the next error in the list and displays the offending line of code in the text window.

### Edit Mode <F4>

Switches to edit mode from run, also known as debug, mode. After successful compilation or execution, no changes to the file are allowed unless in edit mode. If the compilation fails or a runtime error occurs, Dynamic C comes back already in edit mode.

## 16.4 Compile Menu

Click the menu title or press <Alt+C> to select the Compile menu.

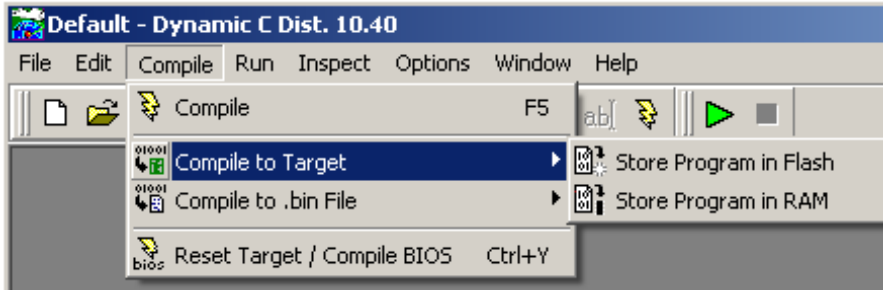

### Compile <F5>

Compiles a program and loads it to the target or to a .bin file. When you press <F5> or select Compile from the Compile menu, the active file will be compiled according to the current compiler options. Compiler options are set in the Compiler tab of the Project Options dialog. When compiling directly to the target, Dynamic C queries the attached target for board information and creates macros to automatically configure the BIOS and libraries.

Any compilation errors are listed in the automatically activated Compiler Messages window. Press <F1> to obtain more information for any error message that is highlighted in this window.

### Compile to Target

Expands to one of two choices. They override any BIOS Memory Setting choice made in the Compiler tab of the Project Options dialog.

- Store Program in Flash
- Store Program in RAM

The compiler will show board type and other board specific information while doing a compile to target. The information shown will be identical to what the compiler shows when compiling to a .bin file.

## Compile to .bin File

Compiles a program and writes the image to a .bin file.

The target configuration used in the compile is determined in the Compiler tab of the Project Options dialog. From there, under “Default Compile Mode,” you can choose to use the attached target or a defined target configuration. The defined target configuration is accessed by clicking on the Targetless tab which will reveal three additional tabs: RTI File, Specify Parameters and Board Selection. To learn more about these tabs see [“Targetless Tab” on page 291](#).

The .bin file may be used with a device programmer to program multiple targets; or the Rabbit Field Utility (RFU) can be used to load the .bin file to the target.

If you are creating a special program such as a cold loader that starts at address 0x0000 you can exclude the BIOS from being compiled into the .bin file by unchecking the option to include it. This is done by choosing Options | Project Options | Compiler and clicking on the “Advanced...” button.

In addition to the .bin file, several other files are generated with this compile option. For example, if you compile `demo1.c` to a .bin file, the following files will be in the same folder as `demo1.c`:

- `DEMO1.bak` - backup of the application source file (made at compile time, when this option is enabled).
- `demo1.bdl` - binary image download file (used when loading the application to a connected target).
- `DEMO1.brk` - debugger breakpoint information.
- `demo1.hdl` - no longer used.
- `demo1.hex` - simple Intel HEX format output image file; the serial DLM samples download a DLP's HEX file and load the image to Flash.
- `DEMO1.map` - the application's code/data map file (`RabbitBios.map` is also generated, separately). For more information on the map file, see [“Map File Generation” on page 335](#)
- `DEMO1.rom` - ROM "output" file, containing redundant addresses (due to fixups); it's used to generate the BDL, BIN, HEX, and HDL files.

## Reset Target/Compile BIOS <Ctrl+Y>

This option reloads the BIOS to RAM or Flash, depending on the choice made under BIOS Memory Setting in the Compiler dialog (viewable from Options | Project Options).

The following message will appear upon successful compilation and loading of BIOS code.



## 16.5 Run Menu

Click the menu title or press <Alt+R> to select the Run menu.



### Run <F9>

Starts program execution from the current breakpoint. Registers are restored, including interrupt status, before execution begins. If in Edit mode, the program is compiled and downloaded.

### Stop <Ctrl+Q>

The “Stop” command stops the program at the current point of execution. Usually, the debugger cannot stop within `nodebug` code. On the other hand, the target can be stopped at an `RST 028h` instruction if an `RST 028h` assembly code is inserted as inline assembly code in `nodebug` code. However, the debugger will never be able to find and place the execution cursor in `nodebug` code.

### Run w/ No Polling <Alt+F9>

This command is identical to the “Run” command, with one exception. The PC polls the target every three seconds by default to determine if the target has crashed. When debugging via RabbitLink, polling is used to make the RabbitLink keep its connection to the PC

open. Polling does have some overhead, but it is very minimal. If debugging ISRs, it may be helpful to disable polling.

### Step Into <F7>

Executes one C statement (or one assembly language instruction if the assembly window is displayed) with descent into functions. If `nodebug` is in effect and the Assembly window is closed, execution continues until code compiled without the `nodebug` keyword is encountered.

### Step Over <F8>

Executes one C statement (or one assembly language instruction if the assembly window is displayed) without descending into functions.

### Source Step Into <Alt+F7>

Executes one C statement with descent into functions when the assembly window is open. If `nodebug` is in effect, execution continues until code compiled without the `nodebug` keyword is encountered.

### Source Step Over <Alt+F8>

Executes one C statement without descending into functions when the assembly window is open.

### Toggle Breakpoint <F2>

Toggles a soft breakpoint at the current cursor location. Soft breakpoints do not affect the interrupt state at the time the breakpoint is encountered, whereas hard breakpoints and hardware breakpoints do.

Breakpoints can be toggled in edit mode as well as in debug mode. Breakpoint information is not only retained when going back and forth from edit mode to debug mode, it is stored when a file is closed and restored when the file is reopened. Breakpoints are set in library code the same way they are set in application code.

## Toggle Hard Breakpoint <Alt+F2>

Toggles a hard breakpoint at the current cursor location. A hard breakpoint differs from a soft breakpoint in that interrupts are disabled when the hard breakpoint is reached. Note that a hard breakpoint is not the same as a [hardware breakpoint](#).

Breakpoints can be toggled in edit mode as well as in debug mode. Breakpoint information is not only retained when going back and forth from edit mode to debug mode, it is stored when a file is closed and restored when the file is reopened. Breakpoints are set in library code the same way they are set in application code.

## Add/Edit Hardware Breakpoints <Shift+Ctrl+F2>

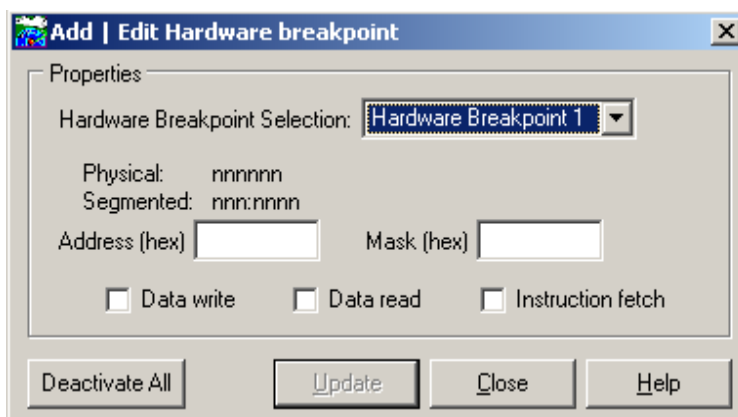

Hardware breakpoints were introduced with the Rabbit 4000 and are supported by Dynamic C beginning with version 10.21.

Choosing this menu item brings up the window pictured here. The drop-down menu allows you to select one of the six available hardware breakpoints (breakpoint 0 is used internally). A breakpoint can be generated on an address match by checking data write, data read, instruction fetch or any combination thereof.

There are two permissible address types: physical ([0x]xxxxxx) and segmented (xxx:xxxx). The address type to use depends on several factors. One factor is the method used to discern the desired address. For example, selecting one of the disassemble options from the Inspect menu opens the Assembly window and displays segmented addresses. Naturally, it saves time to use the address type most readily available.

To disable a single breakpoint, select it in the drop-down menu, uncheck the data write, data read, and/or the instruction fetch boxes and click “Update.” Starting with Dynamic C 10.50, hardware breakpoints are disabled when code is executing within the debug kernel.

The text box labeled “Mask” allows you to mask off any of the 24 bits of the address. A “one” in the mask inhibits the corresponding bit in the address match register from contributing to the address match condition, essentially creating a “don’t care” condition for that address bit. Basically, the mask allows you to express a range of addresses, thus its value should be chosen carefully.

A hardware breakpoint configured for a data write and/or data read can be triggered by internal I/O writes and/or reads. For example, in the following code, with a hardware breakpoint set at address 0x000600 (i.e., VRAM00) for a data read, Dynamic C will stop after the “ld” instruction.

```
void main() {
 #asm debug
 ioi ld a, (VRAM00)
 #endasm
}
```

Note that a hardware breakpoint is not the same as a [hard breakpoint](#). Hardware breakpoints are “hard” in the sense that interrupts are disabled by default when the breakpoint occurs.

### **Clear All Breakpoints <Ctrl+B>**

Clears all software breakpoints. The shortcut was changed to Ctrl+B in Dynamic C 10.21.

### **Poll Target <Ctrl+L>**

A check mark means that Dynamic C will poll the target. The absence of a check mark means that Dynamic C will not poll the target.

If “Poll Target” is selected, Dynamic C sends a message to the target every three seconds and expects a response. If no response is received, Dynamic C ends the debugging session. Several things can be responsible for the target not replying to a polling message, such as loss of power, running in a loop with interrupts disabled, leaving interrupts disabled long enough to disrupt the serial port A ISR, or overwriting serial port A configuration, among other things. Polling does introduce overhead, but it is minimal since it only occurs every three seconds. Without polling turned on, Dynamic C will only notice an unresponsive target when the user attempts to do some other sort of debugging such as stopping the target, setting a breakpoint, single stepping, setting or evaluating a watch, etc.

### **Reset Program <Ctrl+F2>**

Resets program to its initial state. The execution cursor is positioned at the start of the main function, prior to any global initialization and variable initialization. (Memory locations not covered by normal program initialization may not be reset.)

The initial state includes only the execution point (program counter), memory map registers, and the stack pointer. The “Reset Program” command will not reload the program if the previous execution overwrites the code segment. That is, if your code is corrupted, the reset will not be enough; you will have to reload the program to the target.

### **Debug Mode <Shift+F5>**

In Dynamic C you have the ability to switch back to debug mode from edit mode without having to recompile the program.

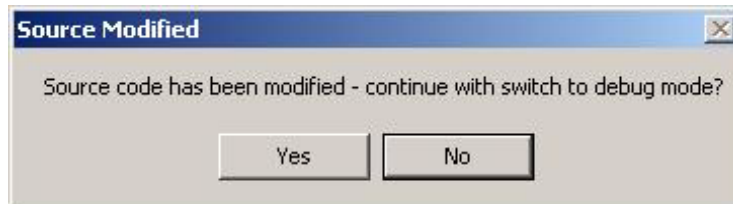

If the source file has been modified while in edit mode, a popup dialog lets you choose whether to run the non-modified code or to go ahead and recompile and download again.

### **Close Connection**

Disconnects the programming serial port between PC and target so that the target serial port and the PC serial port are both accessible to other applications.

## 16.6 Inspect Menu

Click the menu title or press <Alt+I> to open the Inspect menu.

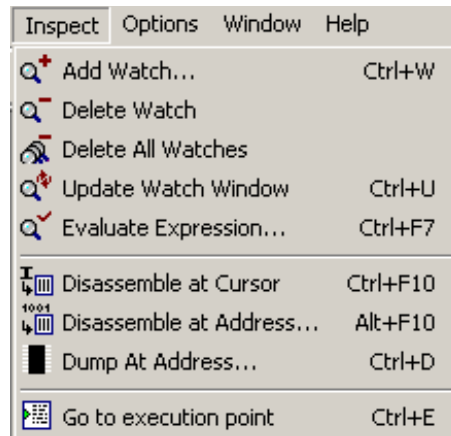

The Inspect menu provides commands to manipulate watch expressions, view disassembled code, and produce hexadecimal memory dumps. The Inspect menu commands and their functions are described here.

### Add Watch <Ctrl+W>

This command displays the “Add Watch Expression” dialog. Enter watch expressions with this dialog box.

A watch expression may be any valid C expression, including assignments, function calls, and preprocessor macros. (Do not include a semicolon at the end of the expression.) If the watch expression is successfully compiled, it and its outcome will appear in the Watches window.



If the cursor in the active window is positioned over a variable or function name, that name will appear in the Watch Expression text box when the Add Watch Expression dialog box appears. Clicking the Add button will add the given watch expression to the watch list, and will leave the Add Watch Expression dialog open so that more watches can be added. Clicking the “OK” button will add the given watch expression to the watch list, and close the Add Watch Expression dialog.

To add a local variable to the Watch window, the target controller’s program counter (PC) must point to the function where the local variable is defined. If the PC points outside the function, an error message will display when “Add” or “OK” is pressed, stating that the variable is out of scope or not declared.

An example of the results displayed in the Watches window appears below.

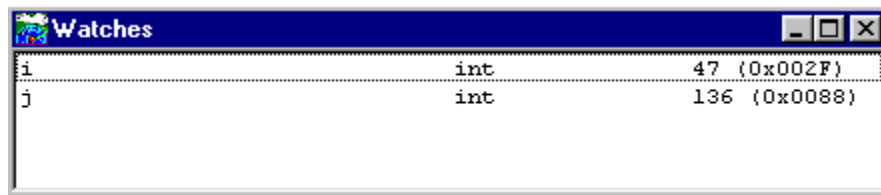

If the evaluation of a watch expression causes a run-time exception, the exception will be ignored and the value displayed in the Watches window for the watch expression will be undefined.

Structure members are displayed whenever a watch expression is set on a struct. The Debug Windows tab of the Environment Options menu lets you set flyover hint evaluation of any expression that can be watched without having to explicitly set the watch expression. See [“Watch” on page 298](#) and [“Watch Window” on page 278](#) for more details.

### Delete Watch

Removes highlighted entry from the Watches window.

### Delete All Watches

Removes all entries from the Watches window.

### Update Watch Window <Ctrl+U>

Forces expressions in the Watches window to be evaluated. If the target is running nodebug code, the Watches window will not be updated, and the PC will lose communication with the target. Inserting an RST 028h instruction into frequently executed nodebug code will allow the Watches window to be updated while running in nodebug code. Normally the Watches window is updated every time the execution cursor is changed, that is, when a single step, a breakpoint, or a stop occurs in the program.

### Evaluate Expression

Brings up the Evaluate Expression dialog where you can enter a single expression in the Expression dialog. The result is displayed in the Result text box when Evaluate is clicked. Multiple Evaluate Expression dialogs can be active at the same time.

### Disassemble at Cursor <Ctrl+F10>

Loads, disassembles and displays the code at the current editor cursor location. This command does not work in user application code declared as nodebug. Also, this command does not stop the execution on the target.

### Disassemble at Address <Alt+F10>

Brings up the Disassemble at Address dialog where you can enter an address at which to begin disassembly. The format of the address is either the logical address specified as a hex number (0xnmmm or just nmmm) or as an xpc:offset pair separated by a colon (nn:mmmm).

The Disassembled Code window displays the result. See [“Assembly \(F10\)” on page 299](#) for details about this window.

## Dump at Address <Ctrl+D>

Allows blocks of raw values in any memory location to be displayed. Values are displayed on the screen or written to a file. If separate I&D space is enabled, you can choose which logical space to examine: instruction space or data space.

Dynamic C highlights differences when displaying to the screen: each time you single step in C or assembly changed data is highlighted in reverse video in the Memory Dump window. (This is also true for the Stack and Register windows.)

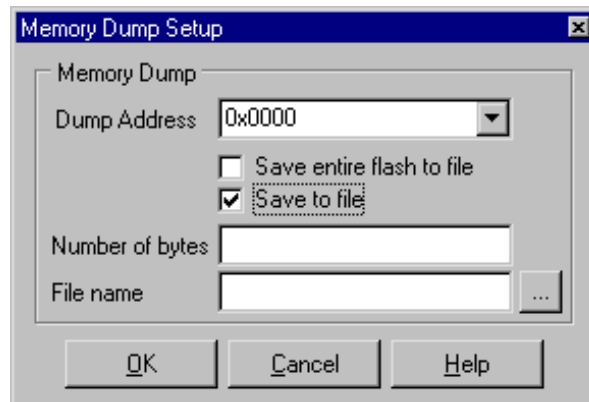

When writing to a file, the option “Save to file” requires a file pathname and the number of bytes to dump. The option “Save entire flash to file” requires a file pathname. If you are running in RAM, then it will be RAM that is saved to a file, not Flash, because this option simply starts dumping physical memory at address zero.

When displaying on a screen, a Memory Dump window is opened. A typical screen display appears below. Although the cursor is not visible in the screen capture below of the Memory Dump window, it is hovering over logical memory location 0x013c, which has a value of 0x79. This information is given in the fly-over text and also in the titlebar. Either or both of these options may be disabled by right clicking in the Memory Dump window or in the Options | Environment Options, Debug Windows tab, under Specific Preferences for the Memory Dump window.

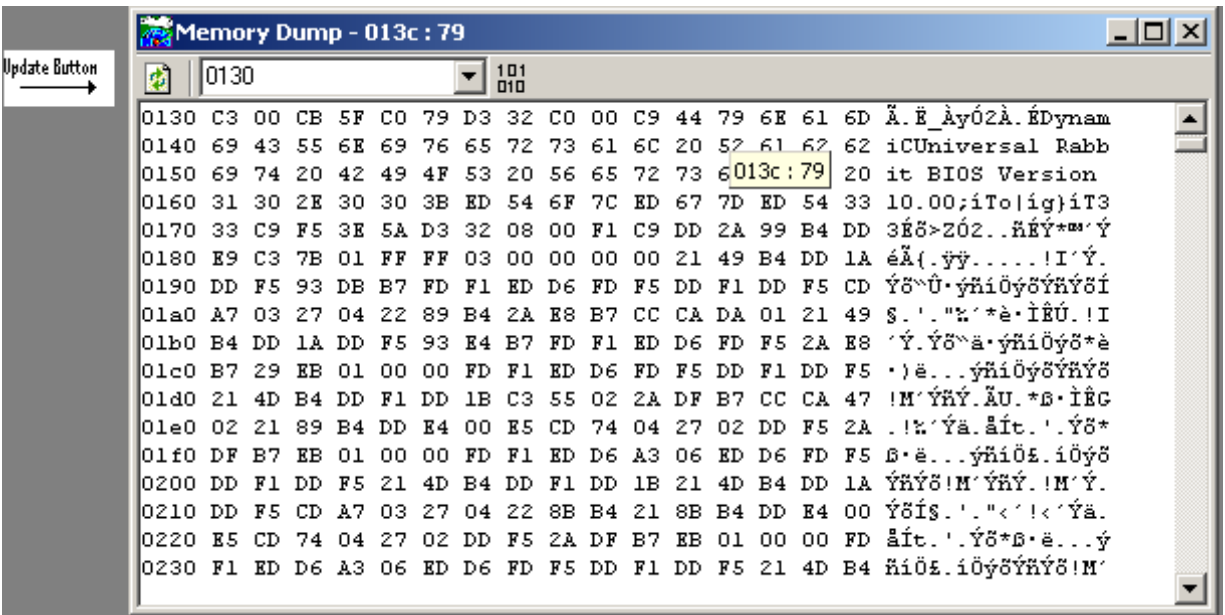

Memory Dump windows may be scrolled. Scrolling causes the contents of other memory addresses to appear in the window. Hotkeys ArrowUp, ArrowDown, PageUp, PageDown are active in the Memory Dump window. The window always displays as many lines of 16 bytes and their ASCII equivalent as will fit in the window.

Values in the Dump window are updated automatically either when Dynamic C stops or comes to a breakpoint. Updates only occur if the window is updateable. This can be set either by right clicking in the Memory Dump window and toggling the updateable menu item, or by clicking on the Debug Windows tab in Options | Environment Options. Select Memory Dump under Specific Preferences, then check the option “Allow automatic updates.” The Memory Dump window can be updated at any time by clicking the Update button on the tool bar or by right clicking and choosing Update from the popup menu.

The Memory Dump window is capable of displaying three different types of dumps. A dump of a logical address ([0x]mmmm) will result in a 64k scrollable region (0x0000 - 0xffff). A dump of a physical address ([0x]mmmmm) will result in a dump of a 1M region (0x00000 - 0xfffff). A dump of an xpc:offset address (nn:mmmm) will result in a segmented dump range of 4k, 64k, or “Full Range,” depending on the size set on the Debug Windows tab on the Options | Environment Options menu.

Note that adding a leading zero to a logical address makes it a physical address.

Any number of dump windows may be open at the same time. The type of dump or dump region for a dump window can be changed by entering a new address in the toolbar’s text entry area. To the right of this area is a button that, when clicked, will cause the address in the text entry area to be the first address in the Dump window. The toolbar for a dump window may be hidden or visible.

### Goto Execution Point <Ctrl+E>

When stopped in debug mode, this option places the cursor at the statement or instruction that will execute next.

## 16.7 Options Menu

Click on the Options menu title or press <Alt+O> to select the Options menu.

### 16.7.1 Environment Options

Dynamic C comes with a built-in, full-featured text editor. It may be customized to suit your style using the Environment Options dialog box. The dialog box has tabs for various aspects of the editor. Note that keyboard shortcuts for some of the options have no character to underline, so the character is shown between brackets. For example, when the Editor menu options are visible, Alt+Q is the keyboard shortcut for toggling the option “Cursor through tabs”.

#### 16.7.1.1 Editor Tab

Click on the Editor tab to display the following dialog. Installation defaults are shown.

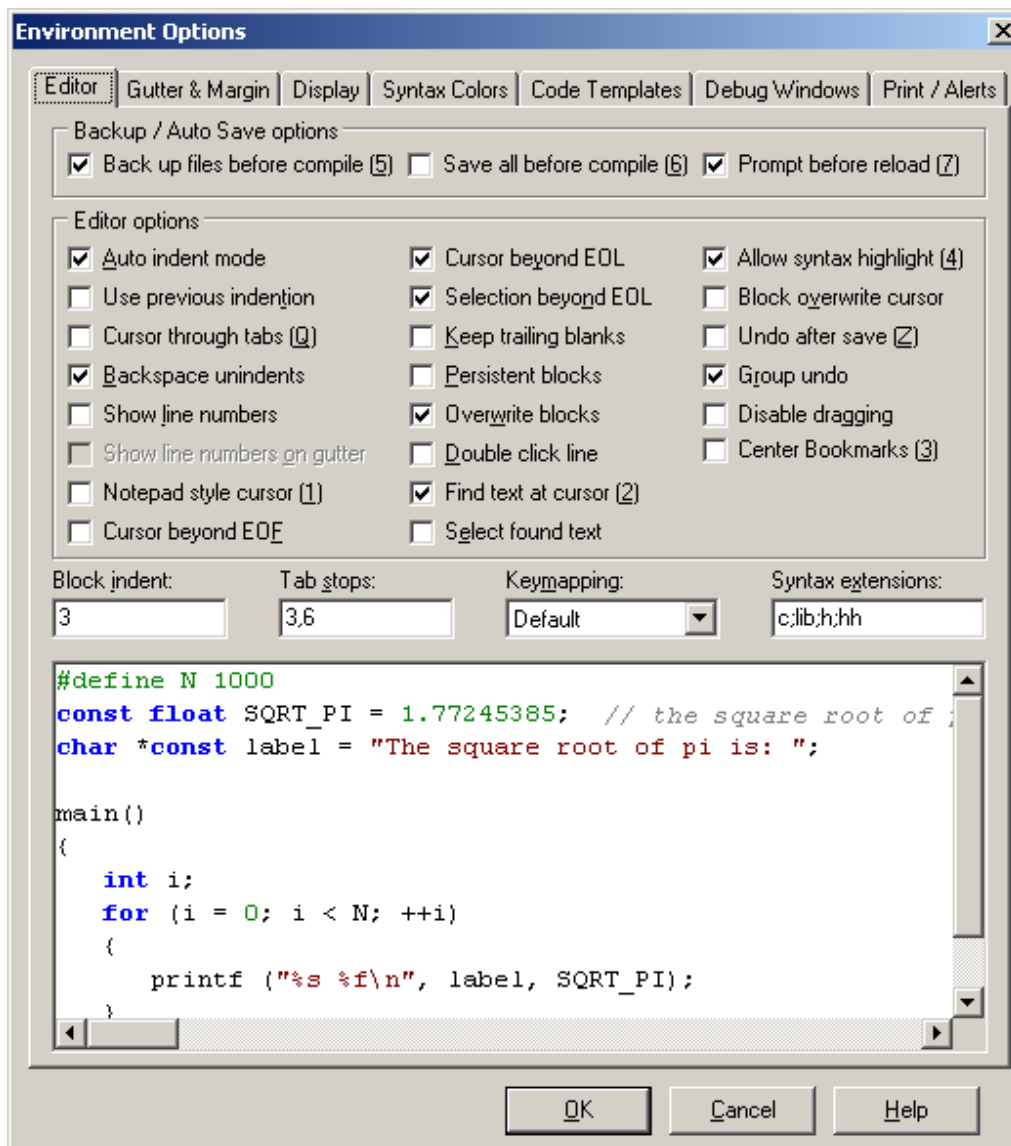

## **Backup / Auto Save Options**

These three features were added in Dynamic C 10.21: automatically backup a file before compilation, automatically save all open editor windows before compilation, turn off the prompt that asks you if you want to reload a modified file.

The Editor options are detailed here. All actions taken are immediately reflected in the text area at the bottom of the dialog, and in any open editor windows.

## **Auto Indent Mode**

Checking this causes a new line to match the indentation of the previous line.

## **Use Previous Indentation**

Uses the same characters for indentation that were used for the last indentation. If the last indentations was 2 tabs and 4 spaces, the next indentation will use the same combination of whitespace characters.

## **Cursor Through Tabs**

With this option checked, the right and left arrow keys will move the cursor through the logical spaces of a tab character. If this is unchecked the cursor will move the entire length of the tab character.

## **Backspace Unindents**

Check this to backspace through indentation levels. If this is unchecked, the backspace will move one character at a time.

## **Show Line Numbers**

Check this to display line numbers in the text window. This must be checked to activate the option Show line numbers on gutter.

## **Show Line Numbers on Gutter**

If gutters are visible, check this to display line numbers in the gutter.

## **Notepad Style Cursor**

Checking this causes the cursor to behave similar to Notepad.

## **Cursor Beyond EOF**

Check this option to move the cursor past the end of the file.

## **Cursor Beyond EOL**

Check this option to move the cursor past the end of the line.

## **Selection Beyond EOL**

Check this option to select text beyond the end of the line.

## **Keep Trailing Blanks**

Check this option to keep extra spaces and tabs at the end of a line when a new line is started.

## Persistent Blocks

Check this option to keep selected text selected when you move the cursor using the arrow keys. Using the mouse to move the cursor will deselect the block of text. Using menu commands or keyboard shortcuts will affect the entire block of selected text. For example, pressing <Ctrl+X> will cut the selected block. But pressing the delete key will only delete one character to the right of the cursor. If this option was unchecked, pressing the delete key would delete all the selected text.

If this option is checked and the Find or Replace dialog is opened with a piece of text selected in the active edit window, the search scope will default to that bit of selected text only.

## Overwrite Blocks

Check this option to enable overwriting a selected block of text by pressing a key on the keyboard. The block of text may be overwritten with any character, including whitespaces or by pressing delete or backspace.

## Double Click Line

Check this option to allow an entire line to be selected when you double click at any position in the line. When this option is unchecked, double clicking will select the closest word to the left of the cursor.

## Find Text at Cursor

When either the Search or Replace dialogs are opened, if this option is checked the word at the cursor location in the active editor window will be placed into the “Text to Find” edit box. If this option is unchecked, the edit box will contain the last search string.

## Select Found Text

The color of found text can be set in Options | Environment Options, on the Syntax Colors page. Select “Search Match” from the Element list box, then set the foreground and background colors.

If this box is unchecked the Search Match color scheme will be used when a match is found, but the text will not be selected for copy or delete operations. If this option is checked, the matched text will automatically be selected so that it may be copied or deleted.

## Use Syntax Highlight

Check this option to enable the Display and Syntax Color choices to be active. When this option is checked, the “Use Syntax Highlighting” in the edit window’s right-click menu allows you to toggle the syntax highlighting in the active file.

## Block Overwrite Cursor

Check this option to show the cursor as a block when an editor is placed in overwrite mode.

## Undo After Save

Check this option to enable undo operations after a file has been saved. With this option unchecked, the undo list for a file is erased each time the file is saved.

## Group Undo

Check this option to undo changes one group at a time. With this option unchecked, each operation is undone individually.

### **Disable Dragging**

Checking this option disables drag and drop operations: i.e., the ability to move selected text by pressing down the left mouse button and dragging the text to a new location.

### **Center Bookmarks**

Check this option so that when you jump to a bookmark it is centered in the editor window.

### **Block Indent**

The number of spaces used when a selected block is indented using `<Ctrl+k+i>` or unindented using `<Ctrl+k+u>`.

### **Tab Stops**

This is a comma separated list of numbers which indicate the number of spaces per tab stop. If only one number is entered, say “3,” then the first tab stop is 3 spaces, as is each additional tab stop. Every additional number in the list indicates the number of spaces for all subsequent tabs. E.g., if the list consists of “3,6,12” the first tab stop is 3 spaces, the second tab stop is 3 more spaces and all subsequent tab stops are 6 spaces.

### **Keymapping**

The keyboard has five different default key mappings: Default, Classic, Brief, Epsilon and Visual Studio. Change the keymapping with this pulldown menu.

### 16.7.1.2 Gutter & Margin Tab

Click on the Gutter & Margin tab to display the following dialog.

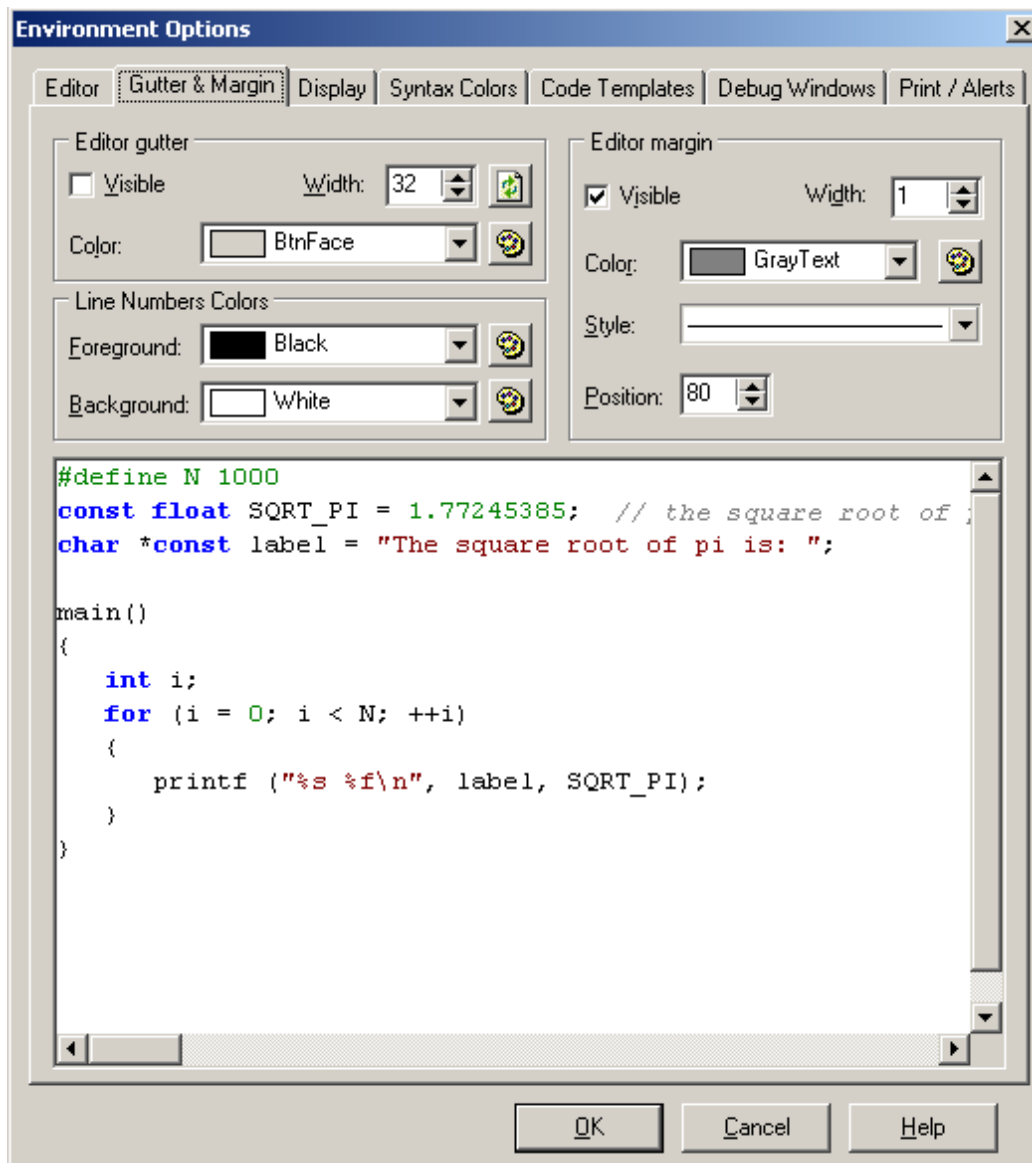

#### Editor gutter

Check the “Visible” box to create a gutter in the far left side of the text window. Use the “Width” scroll bar to set the width of the gutter in pixels. The button to the right updates the width parameter. Changing the width and clicking on OK at the bottom of the dialog does not update the gutter width; you must click on the button. Use the “Color” pulldown menu to set the color. The button to the right brings up more color choices.

#### Editor margin

Check the “Visible” box to create a right-hand margin in the text window. Use the “Width” scroll bar and the “Color” pulldown menu to set the like-named attributes of the margin line. The “Style” pulldown menu displays the line choices available: a solid line and various dashed lines. The “Position” scroll box is used to place the margin at the desired location in the text window.

## Line Number Colors

If line numbers are set to visible and are not placed on the gutter, the Foreground color will set the color of the line numbers and the Background color will set the color on which the line numbers appear.

### 16.7.1.3 Display Tab

Click on the Display tab to display the following dialog.

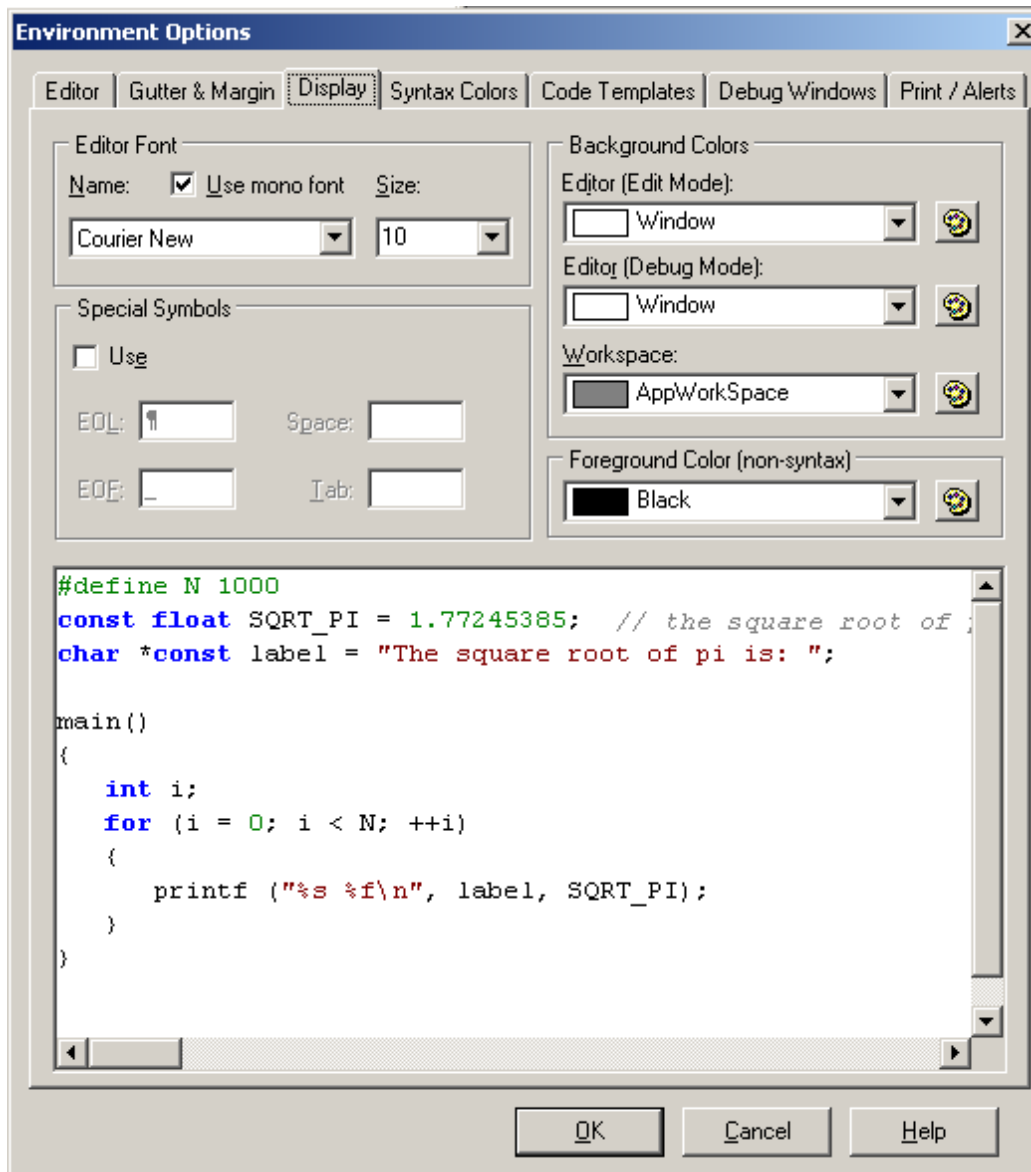

### Editor Font

This area of the dialog box is for choosing the font style and size. Check Use mono font for fixed spacing with each character; note that this option limits the available font styles.

## Special Symbols

Check the box labeled “Use” to view end of line, end of file, space and/or tab symbols in the editor window.

## Background Colors

This area of the dialog box is for choosing background colors for editor windows and the main Dynamic C workspace. The editor window can have a different background color in edit mode than it does in run mode. Each pulldown menu has an icon to the right that brings up additional color choices.

## Foreground Color (non-syntax)

If syntax highlighting is not used, the color selected here will be the foreground color used in the editor file.

### 16.7.1.4 Syntax Colors Tab

Click on the Syntax Colors tab to display the following dialog.

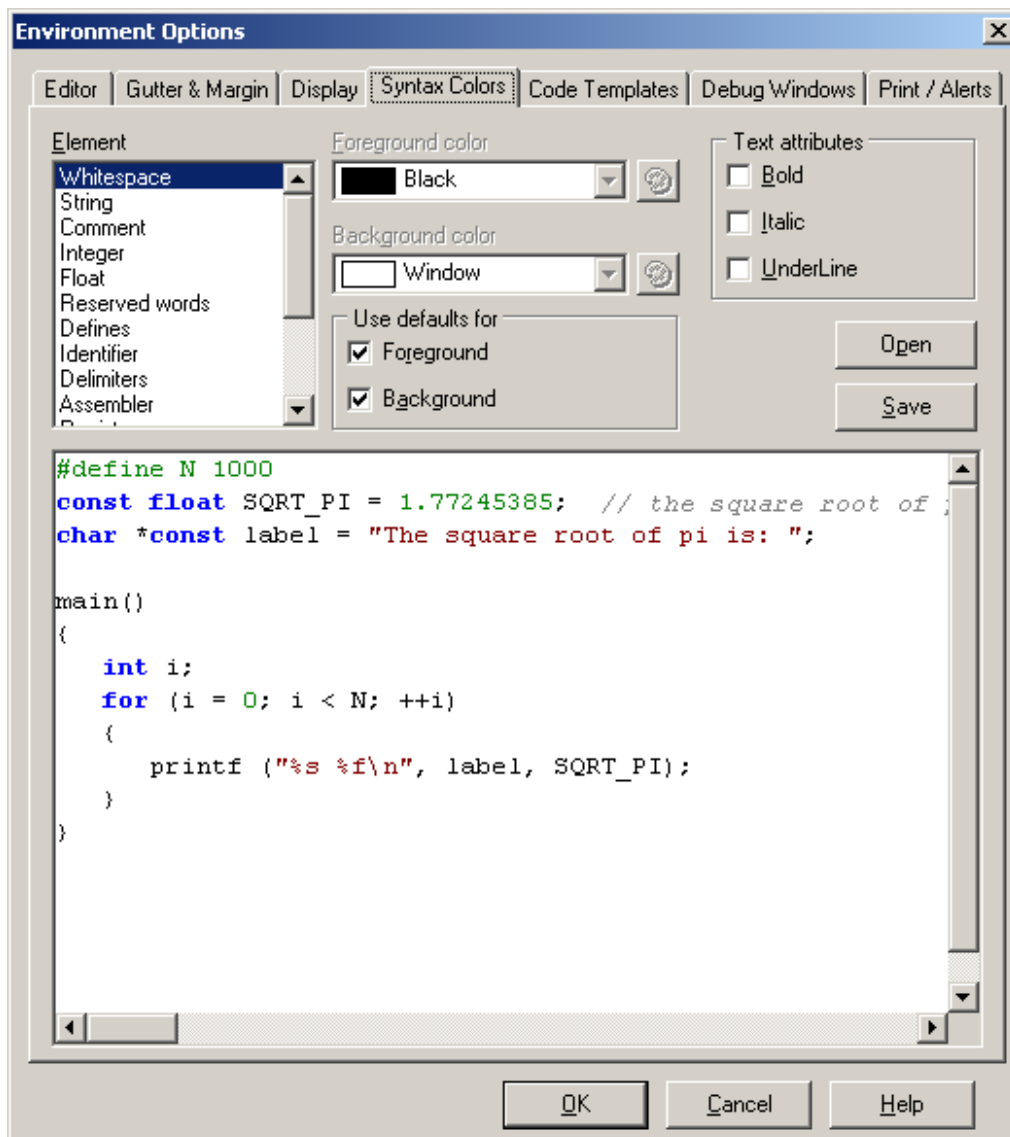

## Element

In this text box are the different elements that may be in a file (strings, comments, integers, etc.). For each one you may choose a foreground and a background color. You may also opt to use the default colors: black for foreground and white for background. In the “Text” attributes area of the dialog box, you may set bold, italic and/or underline for any of the elements.

## Open / Save Buttons

These buttons load and save color styles into files with a .rgb extension. Clicking the “Open” button will bring up an Open File dialog box, where you choose a .rgb file that will set all of the syntax colors. There is a subdirectory titled Schemes under the root Dynamic C directory that has some predefined color schemes that can be used. Opening a .rgb file makes its colors immediately active in all open editor windows. If you close the Environment Options window without saving the changes, the colors will go back to whatever they were before you opened the .rgb file.

### 16.7.1.5 Code Templates Tab

Click the Code Template tab to display the following dialog.

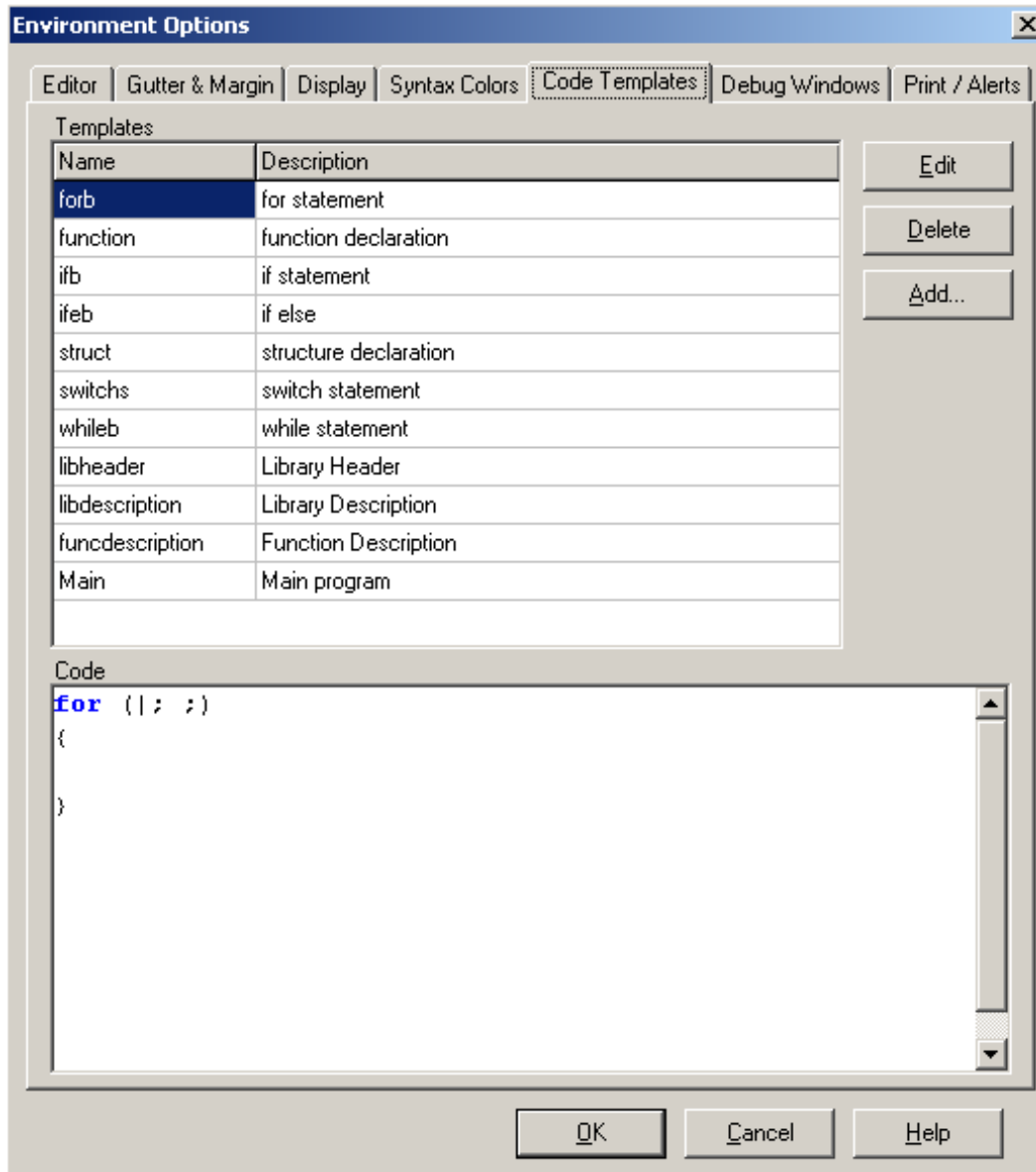

As you can see, there are several predefined templates. The “Edit and Delete” buttons allow the like-named operations on existing templates. The “Add” button gives the ability to create custom templates.

To bring up the list of defined templates, Dynamic C must be in edit mode. Then you must do one of the following: press <Ctrl+j> or right click in the editor window and choose “Insert Code Template” from the popup menu or choose the Edit command menu and select “Insert Code Template.” Clicking on the desired template name inserts that template at the cursor location.

### 16.7.1.6 Debug Windows Tab

Click on the Debug Windows tab to display the following dialog. Here is where you change the behavior and appearance of Dynamic C debug windows.

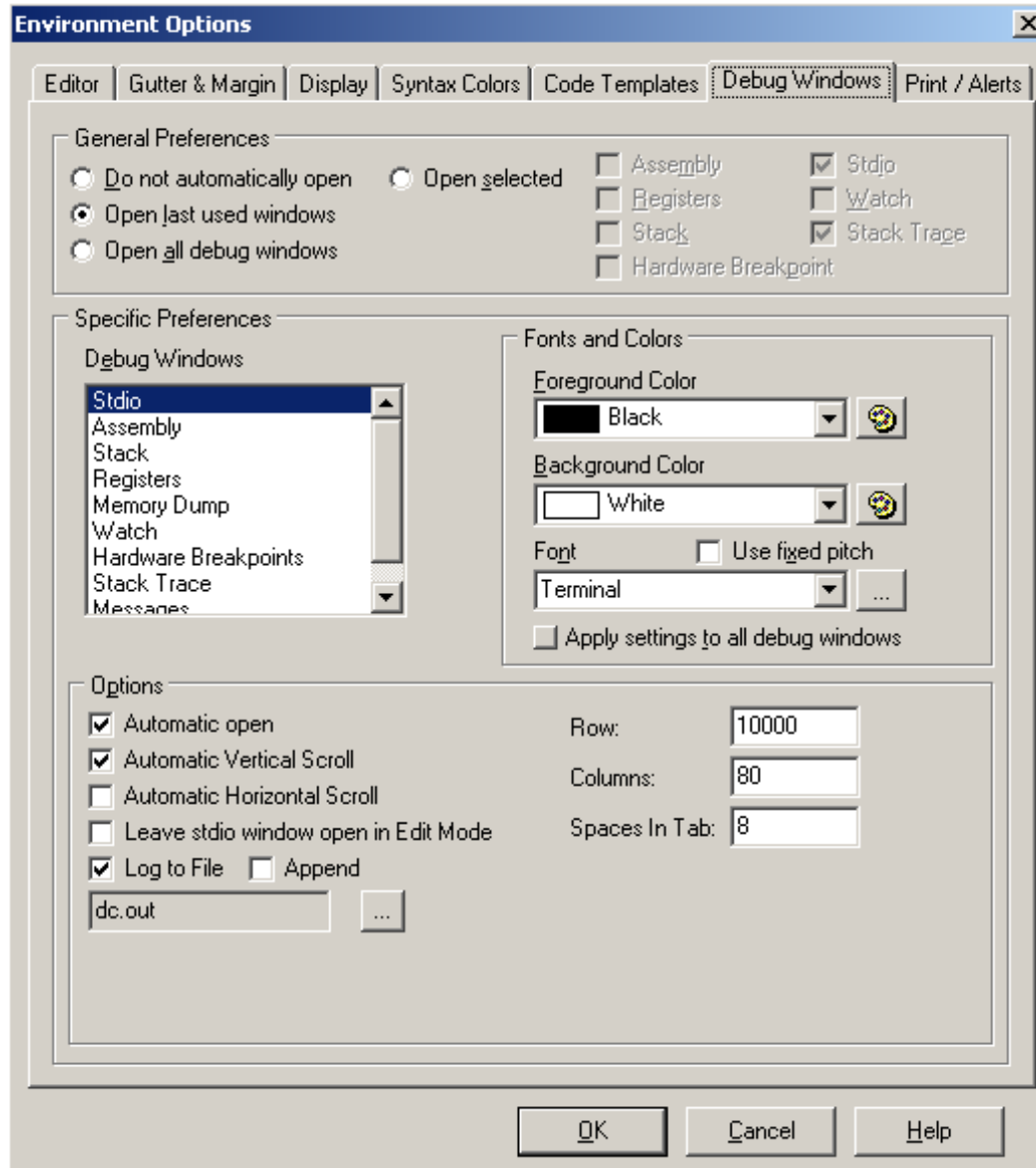

Select which debug windows will be opened after a successful compile under the General Preferences section.

The Specific Preferences section is where you customize each type of window as selected in the Debug Windows list. Colors and fonts are chosen here, as well as other options.

#### Stdio Window

The previous screen shows the options available for the Stdio window<sup>1</sup>. They are described here. You may modify or check as many as you would like.

**Automatic open**

Check this to open the Stdio window the first time `printf()` is encountered.

**Automatic Vertical Scroll**

Check this to force vertical scroll when text is displayed outside the view of the window. If this option is unchecked, the text display doesn't change when the bottom of the window is passed; you have to use the scroll bar to see text beyond the bottom of the window.

**Automatic Horizontal Scroll**

Check this to force horizontal scroll when text is displayed outside the view of the window.

**Automatic Delete in Edit Mode**

Uncheck this to leave the Stdio window open when returning to edit mode. This feature was introduced in Dynamic C 10.21. It is checked by default to behave the same as prior versions of Dynamic C.

**Log to File**

Check this to direct output to a file. If the file does not exist it will be created. If it does exist it will be overwritten unless you also check the option to append the file.

**Rows**

Specifies the maximum number of rows that can hold Stdio data.

**Columns**

Specifies the maximum number of columns that can hold Stdio data. When the maximum column is reached, output automatically wraps to the next row.

**Spaces In Tab**

Tab stops display as the number of spaces specified here.

The various **Find** commands available on the Edit menu can be used directly in the Stdio window.

Starting with Dynamic C 10.21, the "Select All" item available on the Run menu can be used to select all text in the Stdio window. The keyboard shortcut for "Select All" is Ctrl+A.

- 
- i. The macro `STDIO_DEBUG_SERIAL` may be defined to redirect Stdio output to a designated serial port, this can be A, B, C or D. For more information, please see the sample program `Samples/STDIO_SERIAL.C`.

## Assembly Window

The Assembly window displays the disassembled code from the program just compiled. All but the opcode information may be toggled off and on using the checkboxes shown below. For more information about this window see [Section 13.3.5](#).

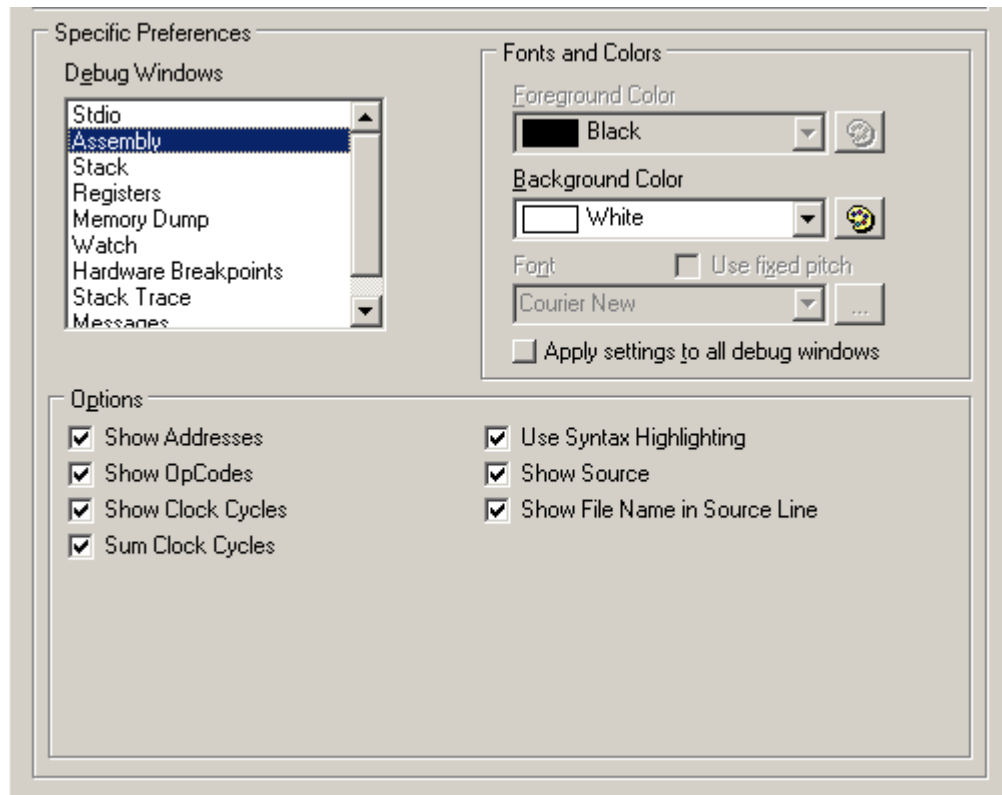

### Show Addresses

Check this to show the logical address of the instruction in the far left column.

### Show OpCodes

Check this to show the hexadecimal number corresponding to the opcode of the instruction.

### Show Clock Cycles

Check this to show the number of clock cycles needed to execute the instruction in the far right column. Zero wait states is assumed. Two numbers are shown for conditional return instructions. The first is the number of cycles if the return is executed, the second is the number of cycles if the return is not executed.

### Sum Clock Cycles

Check this to total the clock cycles for a block of instructions. The block of instructions must be selected and highlighted using the mouse. The total is displayed to the right of the number of clock cycles of the last instruction in the block. This value assumes one execution per instruction, so looping and branching must be considered separately.

### Use Syntax Highlighting

Toggle syntax highlighting. Click on the Syntax tab to set the different colors.

### Show Source

Check this to display the Dynamic C statement corresponding to the assembly code.

### Show File Name in Source Line

Check this to prepend the file name to the Dynamic C statements corresponding to the assembly code.

## Register Window

For this window you must choose one of the following conditions: “Show register history” or “Show registers as editable.” When the Register Contents window opens it will be in editable mode by default. Selecting “Show Register history” will override the default setting.

### Show register history

In this mode, a snapshot of the register values is displayed every time program execution stops. The line (L:) and column (C:) of the cursor is noted, followed by the register and flag values. The window is scrollable and sections may be selected with the mouse, then copied and pasted.

Each time you single step in C or assembly changed data is highlighted in the Register window. (This is also true for the Stack and Memory Dump windows.)

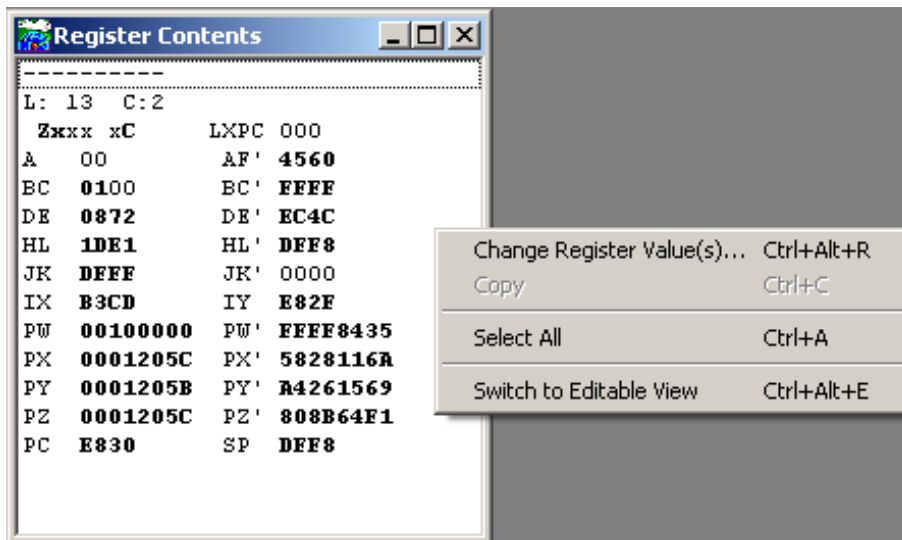

A click of the right mouse button brings up the menu pictured above. Choosing Change Register Value(s)... brings up a dialog where you can enter new values for any of the registers, except SP, PC and LXPC.

### Show registers as editable

In this mode, you can increment or decrement most of the registers, all but the SP, PC and XPC registers.

This screen shows the Register Contents window in editable mode. It is divided into registers on the left and flags on the right.

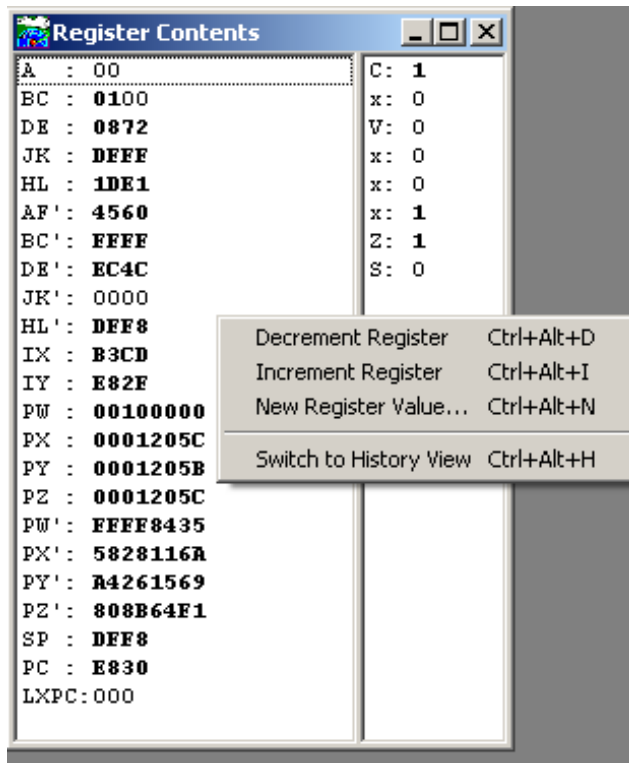

A click of the right mouse button on the register side will bring up the menu pictured here. You can switch to history view or change register values for all but the SP, PC and LXPC registers.

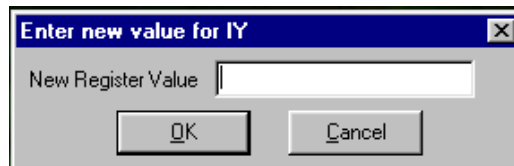

The option New Register Value will bring up a dialog to enter the new register value. Hex values must have “0x” prepended to the value. Values without a leading “0x” are treated as decimal.

A click of the right mouse button on the flags side of the window will bring up a menu that lets you toggle the selected flag (Ctrl+Alt+T) or switch to history view (Ctrl+Alt+H).

## Memory Dump Window

For more information on using the Memory Dump window go to page 261.

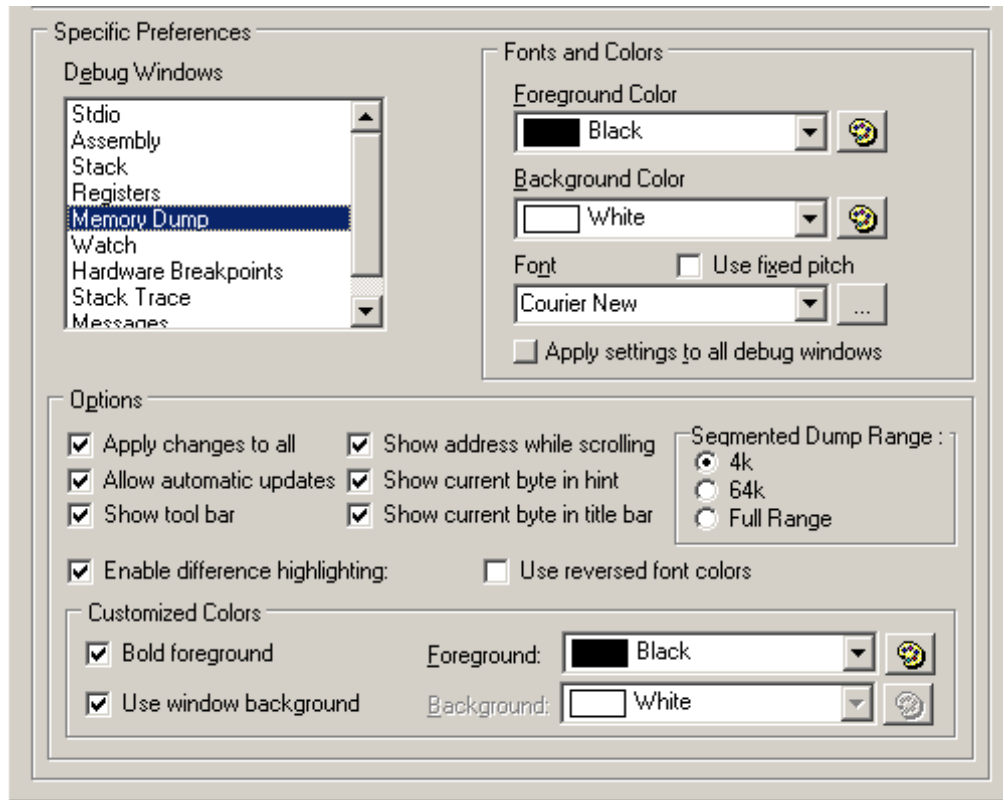

### Apply changes to all

Changes made in this dialog will be applied to all memory dump windows.

### Allow automatic updates

The memory dump window will be updated every time program execution stops (breakpoint, single step, etc.). Each time you single step changed data in the memory dump window is highlighted in reverse video.

### Show tool bar

Each dump window has the option of a tool bar that has a button for updating the dumped region and a text entry box to enter a new starting dump address.

### Show address while scrolling

While using the scroll bar, a small popup box appears to the right of the scroll bar and displays the address of the first byte in the window. This allows you to know exactly where you are as you scroll.

### Show current byte in hint

The address and value of the byte that is under the cursor is displayed in a small popup box.

### Show current byte in title bar

The address and value of the byte that is under the cursor is displayed in the title bar.

### Segmented Dump Range

The memory dump window can display 3 different types of dumps. A dump of a logical address will result in a 64k scrollable region (0x0000 - 0xffff). A dump of a physical address will result in a dump of a 1M region (0x00000 - 0xfffff). A dump of an xpc:offset address will result in either a 4k, 64k or 1M dump range, depending on how this option is set.

If a 4k or 64k range is selected, the dump window will dump a 4k or 64k chunk of memory using the given xpc. If “Full Range” is selected, the window will dump 00:0000 - ff:ffff. To increment or decrement the xpc, use the “+” and “-” buttons located below and above the scroll bar. These buttons are visible only for an xpc:offset dump where the range is either 4k or 64k.

### Watch Window

The Watches window configuration options, Enable watch expression evaluation in flyover hint and Show watch expression evaluation errors in flyover hint, do not actually affect the Watches window. When checked, they allow you to use flyover hints in the source code window to see the value of watchable expressions.

Move the cursor over a variable to see its current value and over a function to see its logical address or its return value. If you highlight the name of a function (e.g., `my_function`) you will see the location of the code in memory. If you highlight the function call (e.g., `my_function(my_parm)`) the function will be called and you will see its return value. If the cursor is over a structure member, the flyover hint will only contain information about the structure, not the individual member.

### Hardware Breakpoints

There are no configuration options for the Hardware Breakpoints window.

### Stack Trace Window

There are no configuration options for the Stack Trace window.

### 16.7.1.7 Print/Alerts Tab

Click on the Print/Alerts tab to display the following dialog. You may access both the Page Setup dialog and Print Preview from here.

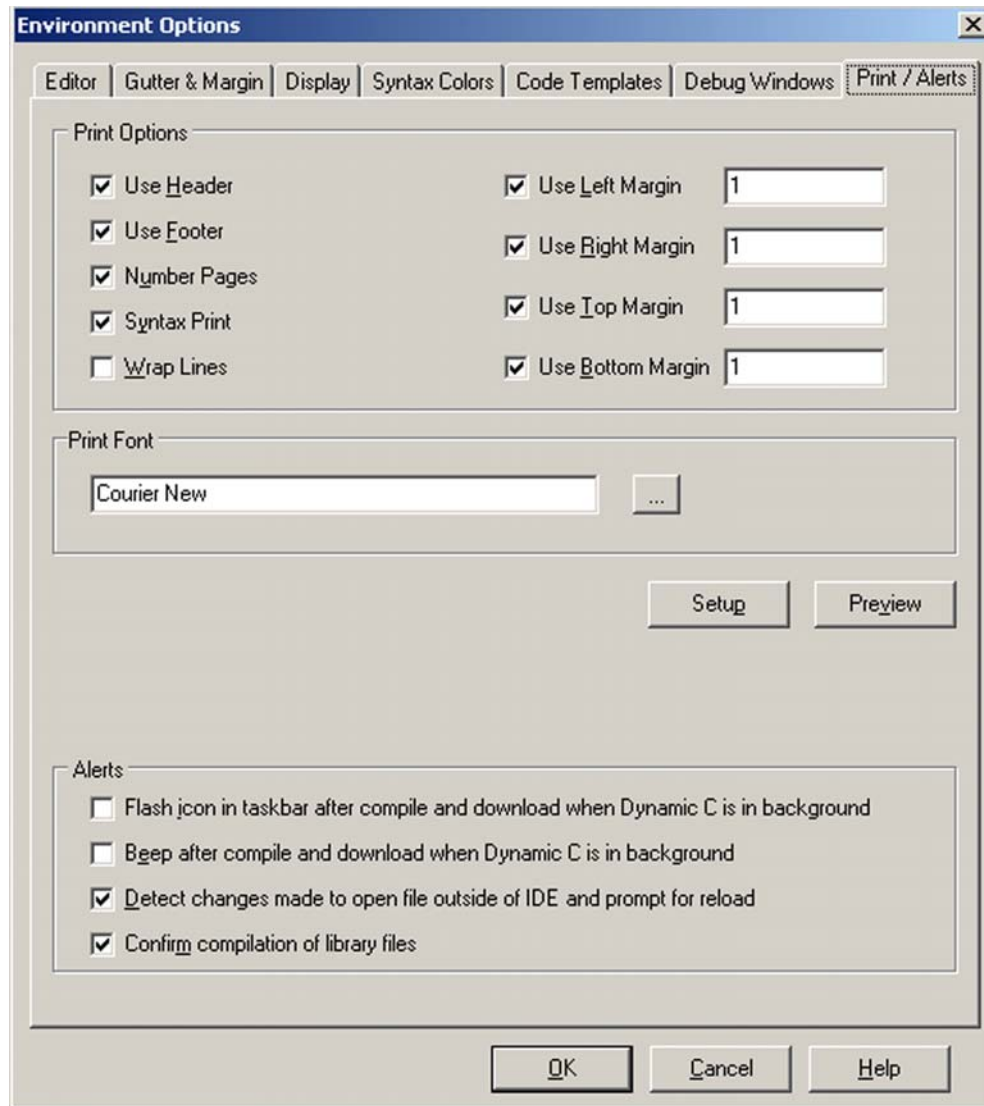

The Page Setup dialog works in conjunction with the Print/Alerts dialog. The Page Setup dialog is where you define the attributes of headers, footers, page numbering and margins for the printed page. The Print/Alerts dialog is where you enable and disable these settings. You may also change the font family and font size that will be used by the printer. This does not apply to the fonts used for headers and footers, those are defined in the Page Setup dialog.

There are four checkboxes in the Alerts area of this dialog. The first two signal a successful compile and download, one with a visual signal, the other auditory. The third checkbox detects if a file that is currently open in Dynamic C has been modified by an external source, i.e., a third-party editor; and if checked, will bring up a dialog box asking if you want to reload the modified file so that Dynamic C is working with the most current version. The last checkbox, if checked, causes Dynamic C to query when an attempt is made to compile a library file to make sure that is what is desired.

You may choose zero or more of these alerts.

## 16.7.2 Project Options

Settings used by Dynamic C to communicate with a target, and to compile and run programs are accessible by using the Project Options dialog box. The dialog box has tabs for various aspects of communicating with the target, the BIOS and the compiler.

### 16.7.2.1 Communications Tab

This is where you setup for serial communication. The following options are available when the Use Serial Connection radio button is selected.

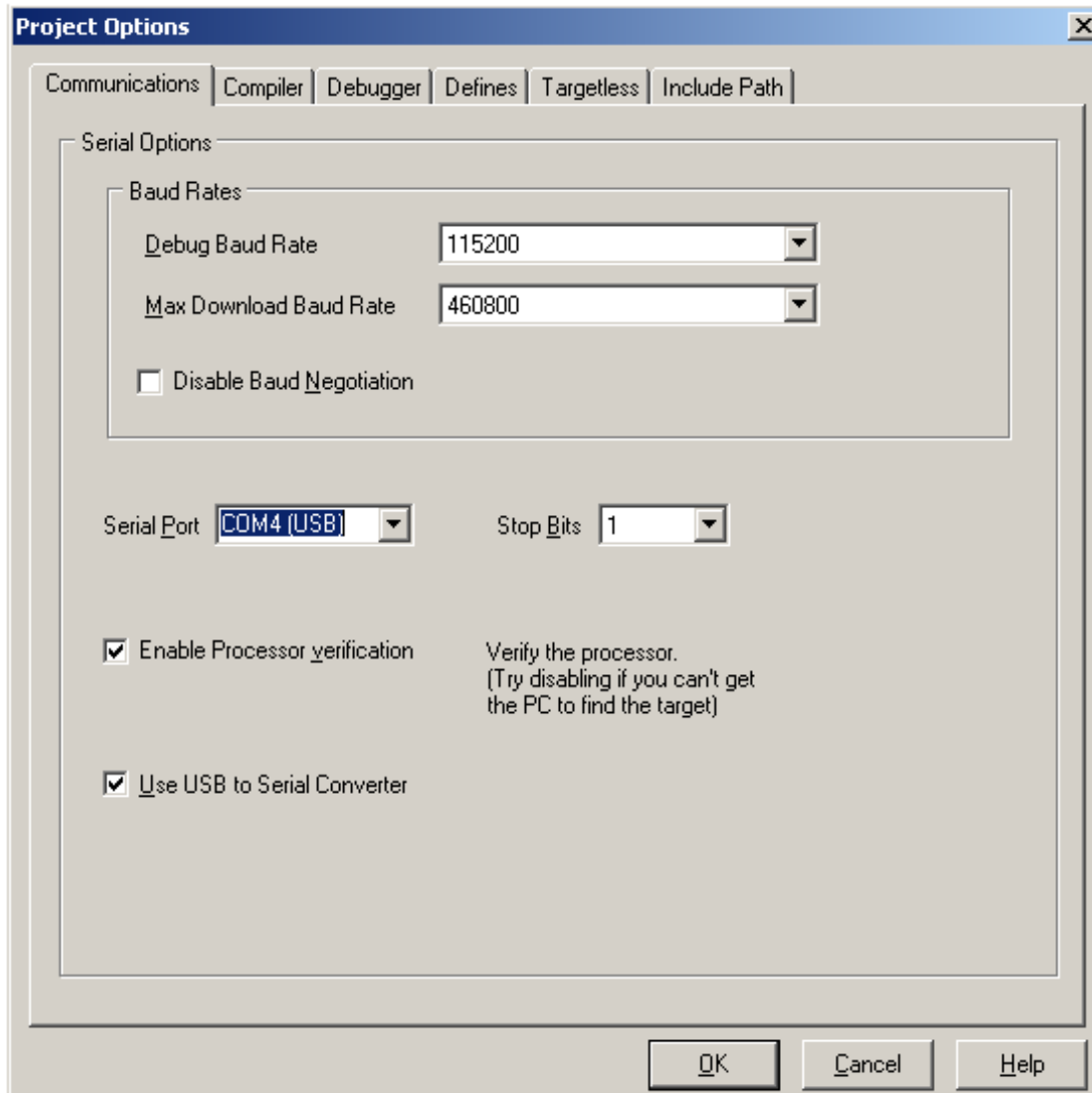

#### Debug Baud Rate

This defaults to 115200 bps. It is the baud rate used for target communications after the program has been downloaded.

#### Max Download Baud Rate

When baud negotiation is enabled, Dynamic C will start out at the selected baud rate and work downwards until it reaches one both it and the target can handle.

## **Disable Baud Negotiation**

Dynamic C negotiates a baud rate for program download. (This helps with USB or anyone who happens to have a high-speed serial port.) This default behavior may be disabled by checking the Disable Baud Negotiation checkbox. When baud negotiation is disabled, the program will download at 115k baud or 56k baud only. When enabled, it will download at speeds up to 460k baud, as specified by Max Download Baud Rate.

## **Serial Port**

This drop-down menu lists PC COM ports that may be connected to the Rabbit-based target. It defaults to COM1. Starting with version 10.21, Dynamic C identifies which ones are USB ports.

## **Stop Bits**

The number of stop bits used by the serial drivers. Defaults to 2.

## **Enable Processor Verification**

Processor detection is enabled by default. The connection is normally checked with a test using the Data Set Ready (DSR) line of the PC serial connection. If the DSR line is not used as expected, a false error message will be generated in response to the connection check.

To bypass the connection check, uncheck the “Enable Processor Verification” checkbox. This allows custom designed systems to not connect the STATUS pin to the programming port. Also, disabling the connection check allows non-standard PC ports or USB converters that might not implement the DSR line to work.

## **Use USB to Serial Converter**

Check this checkbox if a USB to serial converter cable is being used. Dynamic C will then attempt to compensate for abnormalities in USB converter drivers. This mode makes the communications more USB/RS232 converter friendly by allowing higher download baud rates and introducing short delays at key points in the loading process. Checking this box may also help non-standard PC ports to work properly with Dynamic C.

### 16.7.2.2 Compiler Tab

Click on the Compiler tab to display the following dialog. If you are using a version of Dynamic C prior to 10.21, you will not have the section labeled, “Attached Target Memory Type” shown in the following screenshot. All other sections apply. If you are using a Rabbit 4000 with Dynamic C 10.21 or later, all sections shown below apply.

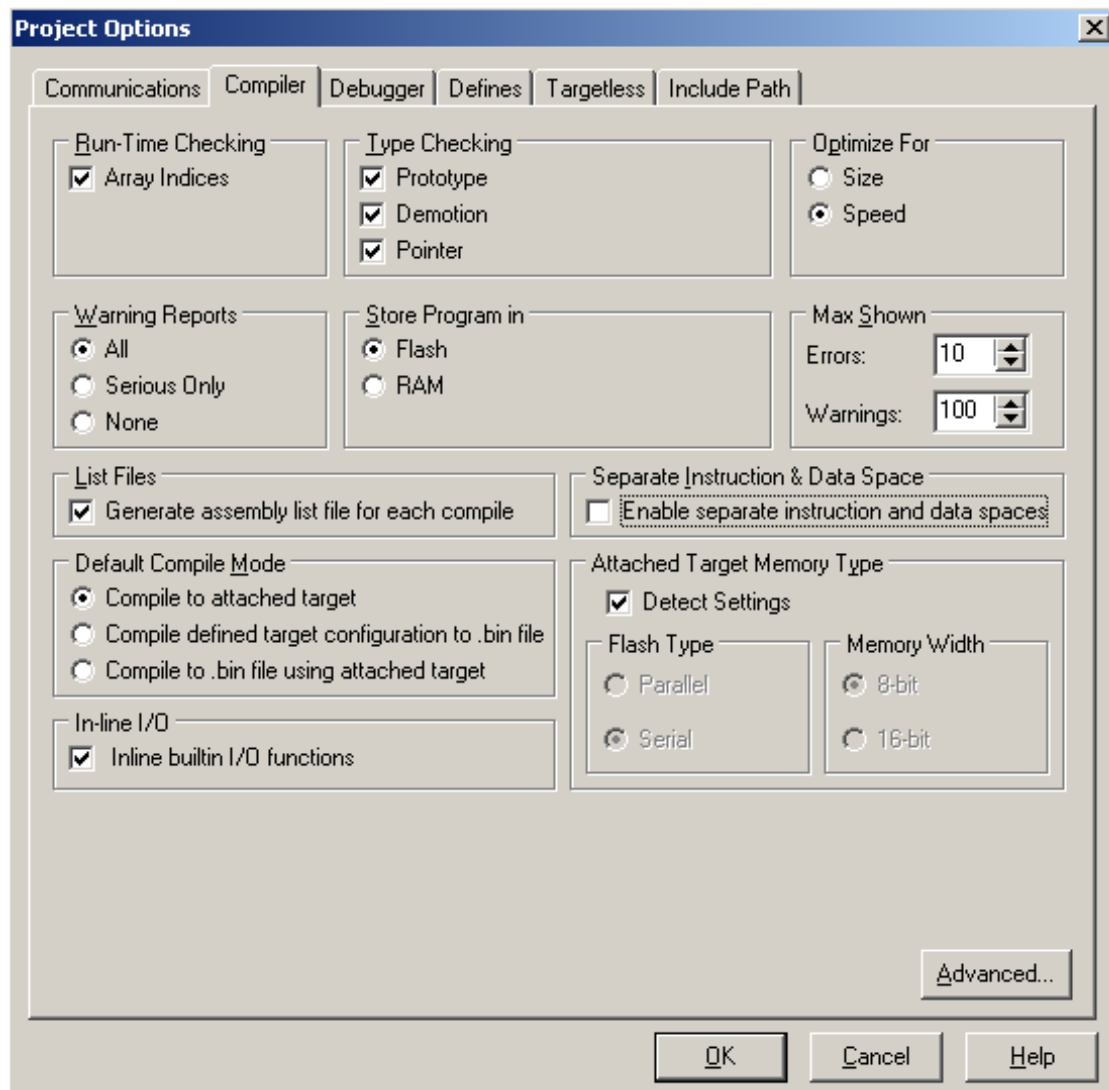

#### Run-Time Checking

These options, if checked, can allow a fatal error at run time. They also increase the amount of code and cause slower execution, but they can be valuable debugging tools.

#### Array Indices

Check array bounds. This feature adds code for every array reference.

## Pointers

This was removed as an option in Dynamic C 10.50. In prior versions: check for invalid pointer assignments. A pointer assignment is invalid if the code attempts to write to a location marked as not writable. Locations marked not writable include the *entire* root code segment. This feature adds code for every pointer reference.

Functions marked as `nodebug` disable the run-time checking options selected in the GUI.

## Type Checking

### Prototypes

Performs strict type checking of arguments of function calls against the function prototype. The number of arguments passed must match the number of parameters in the prototype. In addition, the types of arguments must match those defined in the prototype. Rabbit recommends prototype checking because it identifies likely run-time problems. To use this feature fully, all functions should have prototypes (including functions implemented in assembly).

### Demotion

Detects demotion. A demotion automatically converts the value of a larger or more complex type to the value of a smaller or less complex type. The increasing order of complexity of scalar types is:

```
char
unsigned int
int
unsigned long
long
float
```

A demotion deserves a warning because information may be lost in the conversion. For example, when a `long` variable whose value is `0x10000` is converted to an `int` value, the resulting value is `0`. The high-order 16 bits are lost. An explicit type casting can eliminate demotion warnings. All demotion warnings are considered non-serious as far as warning reports are concerned.

### Pointer

Generates warnings if pointers to different types are intermixed without type casting. While type casting has no effect in straightforward pointer assignments of different types, type casting does affect pointer arithmetic and pointer dereferences. All pointer warnings are considered non-serious as far as warning reports are concerned.

## Optimize For

Allows for optimization of the program for size or speed. When the compiler knows more than one sequence of instructions that perform the same action, it selects either the smallest or the fastest sequence, depending on the programmer's choice for optimization.

The difference made by this option is less obvious in the user application (where most code is not marked `nodebug`). The speed gain by optimizing for speed is most obvious for functions that are marked `nodebug` and have no auto local (stack-based) variables.

## Warning Reports

This option tells the compiler whether to report all warnings, no warnings or serious warnings only. It is advisable to let the compiler report all warnings because each warning is a potential run-time bug. Demotions (such as converting a `long` to an `int`) are considered non-serious with regard to warning reports.

## Store Program in

This option selects the memory type (Flash or RAM) in which to store the program.

A single, default BIOS source file defined in the system registry when installing Dynamic C is used for compiling both to RAM and Flash.

### Flash<sup>i</sup>

With this option, the compiler will load the BIOS to Flash when cold-booting, and will compile the user program to Flash where it will normally reside. For boards with serial boot flashes, the BIOS will copy the flash image to the fast RAM.

### RAM

With this option, the compiler will load the BIOS to RAM when cold-booting and compile the user program to RAM. This option is useful if you want to use breakpoints while you are debugging your application, but you don't want interrupts disabled while the debugger writes a breakpoint to Flash (this can take 10 ms to 20 ms or more, depending on the Flash type used). It is also possible to have a target that only has RAM for use as a slave processor, but this requires more than checking this option because hardware changes are necessary that in turn require a special BIOS and coldloader.

## Max Shown

The scroll menus labeled "Errors" and "Warnings" limit the number of error and warning messages displayed after compilation.

## List Files

Checking this option generates an assembly list file for each compile. A list file contains the assembly code generated from the source file.

The list file is placed in the same directory as your program, with the name `<Program Name>.LST`. The list file has the same format as the Disassembled Code window. Each C statement is followed by the generated assembly code. Each line of assembly code is broken down into memory address, opcode, instruction and number of clock cycles. See [page 299](#) for a screen shot of the Disassembled Code window.

## Separate Instruction and Data Space

When checked, this option enables separate I&D space, doubling the amount of root code and root data space available.

Please note that if you are compiling to a 128K RAM, there is only about 12K available for user code when separate I&D space is enabled.

---

i. For boards with serial boot flashes, selecting "Flash" is the same as the command line compiler `-mfr` option.

## Default Compile Mode

One of the following options will be used when Compile | Compile is selected from the main menu of Dynamic C or when the keyboard shortcut <F5> is used. The setting shown here may be overridden by choosing a different option in the Compile menu. The setup for targetless compile may differ for some board series. Please check your user manual for differences in setup.

### Compile to attached target

a program is compiled and loaded to the attached target.

### Compile defined target configuration to .bin file

a program is compiled and the image written to a .bin file. The target configuration used in the compile is taken from the parameters specified in Options | Project Options. The Targetless tab allows you to choose an already defined board type or you may define one of your own.

### Compile to .bin file using attached target

a program is compiled and the image written to a .bin file using the parameters of the attached controller.

## Attached Target Memory Type

One of the following options must be selected:

### Detect Settings

Checking this option directs Dynamic C to query the attached board as to its program flash type.

### Flash Type

Uncheck “Detect Settings” to activate the “Flash Type” option. The choices are parallel and serial flash.

### Memory Width

Selecting “Parallel” for the flash type activates the “Memory Width” option, offering a choice of 8- or 16-bit parallel flash.

## In-line I/O

If checked, the built-in I/O functions (`WrPortI()`, `RdPortI()`, `BitWrPortI()` and `BitRdPortI()`) will have efficient inline code generated instead of function calls if all arguments are constants, with the exception of the 3rd parameter of `BitWrPortI()` and `WrPortI()`, which may be any valid expression.

If this box is checked, but a call to one of the aforementioned functions is made with non-constant arguments, (with the exception of the 3rd parameter for the 2 write functions) then a normal function call is generated.

## Advanced... Button

Click on this button to reveal the Advanced Compiler Options dialog.

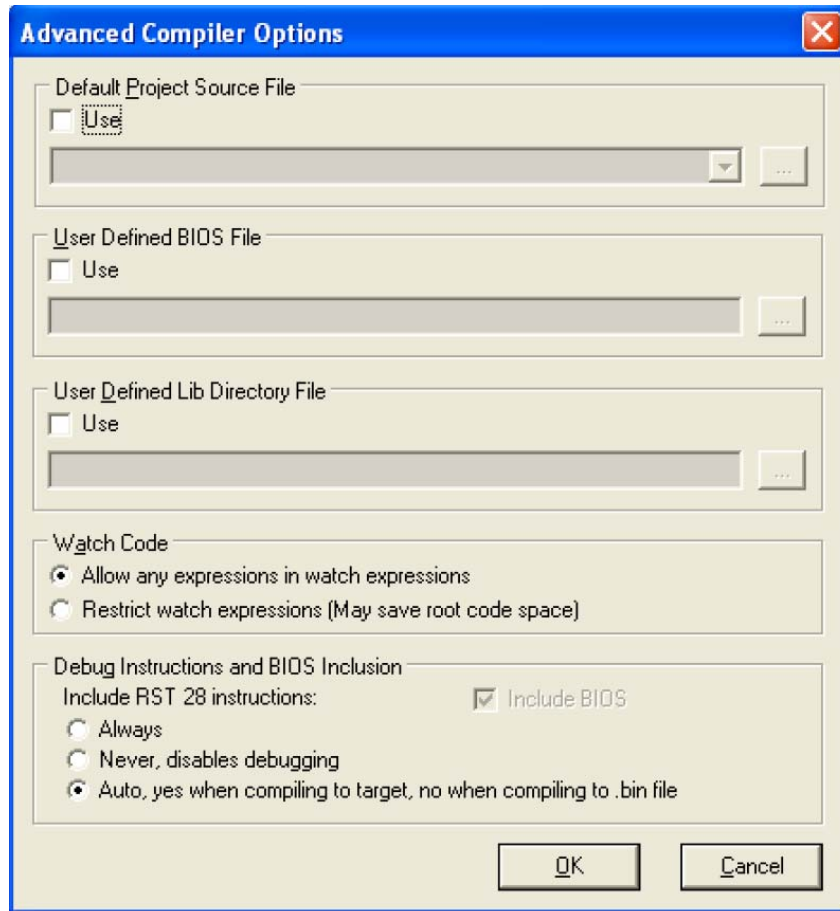

### Default Project Source File

Use this option to set a default source file for your project. If this box is checked, then when you compile, the source file named here will be used and not the file that is in the active editor window. If the file named here is not open, it will be opened into a new editor window, which will be the new active editor window.

### User Defined BIOS File

Use this option to change from the default BIOS to a user-specified file. Enter or select the file using the browse button/text box underneath this option. The check box labeled "use" must be selected or else the default file BIOS defined in the system registry will be used. See the *Rabbit 4000 Designer's Handbook* for more BIOS information.

### **User Defined Lib Directory File** (same as the command line compiler option “-If”)

The Library Lookup information retrieved with <Ctrl+H> is parsed from the libraries found in the “lib.dir” file, which is part of the Dynamic C installation. Checking the Use box for User Defined Libraries File, allows the parsing of a user-defined replacement for the “lib.dir” file. Library files must be listed in the “lib.dir” file (or its replacement) to be available to a program.

If the function description headers are formatted correctly (see “[Function Description Headers](#)” on page 40), the functions in the libraries listed in the user-defined replacement for the “lib.dir” file will be available with <Ctrl+H> just like the user-callable functions that come with Dynamic C.

### **Watch Code**

#### **Allow any expressions in watch expressions**

This option causes any compilation of a user program to pull in all the utility functions used for expression evaluation.

#### **Restricting watch expressions (May save root code space)**

Choosing this option means only utility code already used in the application program will be compiled.

### **Debug Instructions and BIOS Inclusion**

#### **Include RST 28 instructions**

There are three radio buttons for this option:

If “Always” is selected, the debug and nodebug keywords and compiler directives work as normal. Debug code consists mainly of RST 28h instructions inserted after every C statement. This selection also controls the definition of a compiler-defined macro symbol, `DEBUG_RST`. If the menu item is checked, then `DEBUG_RST` is set to one, otherwise it is zero.

If “Never, disables debugging” is selected, the compiler marks all code as nodebug and debugging is not possible.

The default selection is “Auto, yes when compiling to target, no when compiling to .bin file”.

The only reason to include RST 28 instructions if debugging is finished and the program is ready to be deployed, is to allow some current (or planned) diagnostic capability of the Rabbit Field Utility (RFU) to work in a deployed system. This option affects both code compiled to .bin files and code compiled to the target. To run the program after compiling to the target with RST 28 instruction included, disconnect the target from the programming port and reset the target CPU.

#### **Include BIOS**

If this is checked, the BIOS, as well as the user program, will be included in the .bin file. If you are creating a special program such as a cold loader that starts at address 0x0000, then this option should be unchecked.

When you are compiling a program to the attached target controller, the BIOS is always included.

### 16.7.2.3 Debugger Tab

Click on the Debugger tab to display the following dialog. This is where you enable/disable debugging tools. Disabling parts of the debug kernel saves room to fit tight code space requirements.

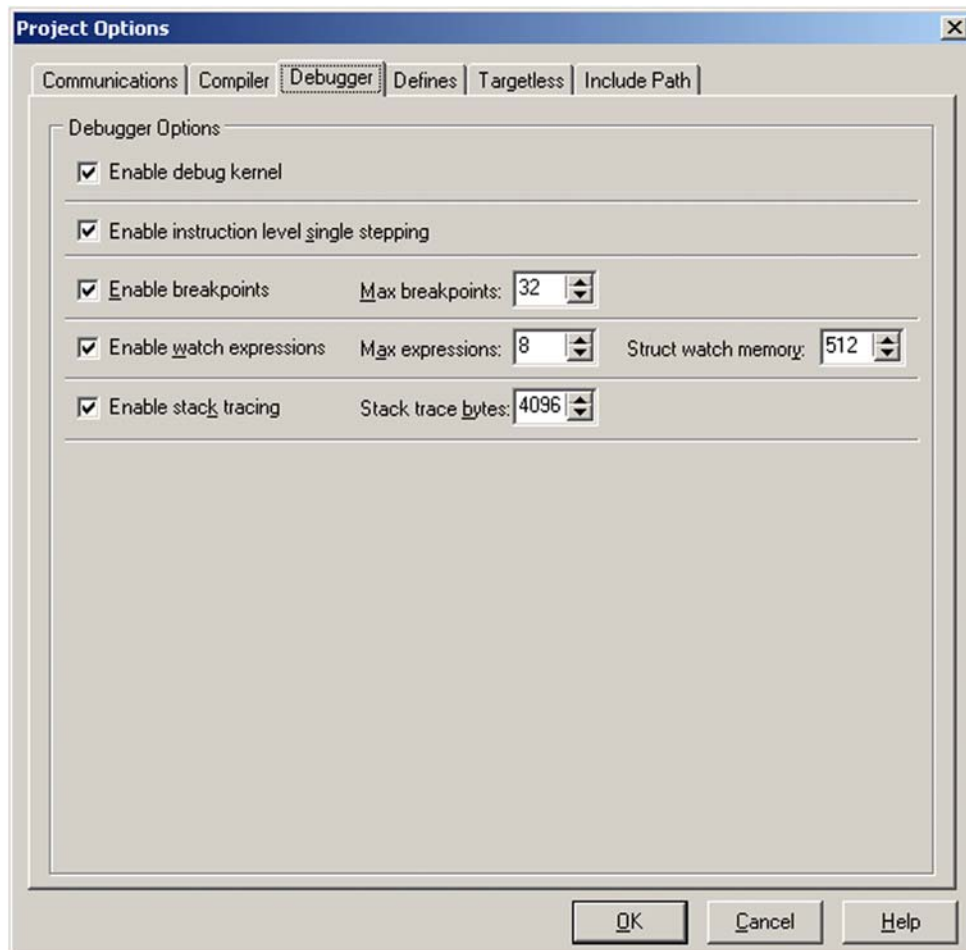

#### Enable debug kernel

Leaving this option unchecked allows you to compile your application without the debug kernel. You must check this option to set any of the other debug options.

#### Enable instruction level single stepping

If this is checked when the assembly window is open, single stepping will be by instruction rather than by C statement. Unchecking this box will disable instruction level single stepping on the target and, if the assembly window is open, the debug kernel will step by C statement.

#### Enable breakpoints

If this box is checked, the debug kernel will be able to toggle breakpoints on and off and will be able to stop at set breakpoints. This is where you set the maximum number of breakpoints the debug kernel will support. The debug kernel uses a small amount of root RAM for each breakpoint, so reducing the number of breakpoints will slightly reduce the amount of root RAM used.

If this box is unchecked, the debug kernel will be compiled without breakpoint support and the user will receive an error message if they attempt to add a breakpoint.

## Enable watch expressions

If this box is checked, watch expressions will be enabled. This is where you set the maximum number of watch expressions the debug kernel will support. The debug kernel uses a small amount of root RAM for evaluating each watch expression, so reducing the number of watches will slightly reduce the amount of root RAM used.

With the watch expression box unchecked, the debug kernel will be compiled without watch expressions support and the user will receive an error message if they attempt to add a watch expression.

Watch expressions automatically include the addition of structure members when a watch expression is set on a struct. Some extended memory is reserved for handling watch expressions on structs. As shown in the above screen shot, 512 bytes of `xmem` is reserved by default. This can be changed to anything in the range 32 to 4096. Be aware that this watch memory is a tradeoff: not only does it dictate the number and complexity of watched structs, but also impacts the amount of memory available for `xalloc()` calls.

## Enable stack tracing

If this box is checked the Stack Trace window is available to show the function call sequence leading to any point at which the program is stopped. The Stack Trace window shows a concise history of the execution path and values of local variables and function arguments that led to the current breakpoint, all for a very small cost in execution time and BIOS memory.

To the right of the checkbox is a spin/edit box for entering the maximum number of bytes of the current stack to transfer from the target at each breakpoint. The allowable range is 32 bytes to 4096 bytes inclusive. The default is 4096 bytes. If the stack depth is smaller than the number in this spin/edit box, only the depth number of bytes is transferred.

With the “Enable stack tracing” box unchecked, the debug kernel and the user program will be compiled without stack tracing support. Changing the status of the checkbox or the number of stack trace bytes forces a recompilation of the BIOS the next time the user program is compiled.

See “[Stack Trace \(Ctrl+T\)](#)” on page 301 for details on using this debug window.

#### 16.7.2.4 Defines Tab

The Defines tab brings up a dialog box with a window for entering (or modifying) a list of defines that are global to any source file programs that are compiled and run. The macros that are defined here are seen by the BIOS during its compilation.

##### Syntax:

DEFINITION[DELIMITER DEFINITION[DELIMITER DEFINITION[...]]]

DEFINITION: MACRONAME[[WS]=[WS]VALUE]

DELIMITER: ';' or 'newline'

MACRONAME: the same as for a macro name in a source file

WS: [SPACE[SPACE[...]]]

VALUE: CHR[CHR[...]]

CHR: any character except the delimiter character ';', which is entered as the character pair "\i;"

##### Notes:

- Do not continue a definition in this window with '\', simply continue typing as a long line will wrap.
- In this window hitting the Tab key will not enter a tab character (\t), but will tab to the OK button.
- The command line compiler honors all macros defined in the project file that it is directed to use with the project file switch, `-pf`, or `default.dcp` if `-pf` is not used. See command line compiler documentation.
- A macro redefined on the command line will supersede the definition read from the project file.

## Examples and File Equivalents:

Example:

```
DEF1;MAXN=10;DEF2
```

Equivalent:

```
#define DEF1
#define MAXN 10
#define DEF2
```

Example:

```
DEF1
MAXN = 10
DEF2
```

Equivalent:

```
#define DEF1
#define MAXN 10
#define DEF2
```

Example:

```
STATEMENT = A + B = C\;;DEF1=10
```

Equivalent:

```
#define STATEMENT A + B = C;
#define DEF1 10
```

Example:

```
STATEMENT = A + B = C\;
FORMATSTR = "name = %s\n"
DEF1=10
```

Equivalent:

```
#define STATEMENT A + B = C;
#define FORMATSTR "name = %s\n"
#define DEF1 10
```

### 16.7.2.5 Targetless Tab

Click on the Targetless tab to reveal three additional tabs: RTI File, Specify Parameters and Board Selection. The setup for targetless compile may differ for some board series. Please check your user manual for differences in setup.

#### RTI File

Click on this tab to open a Rabbit Target Information (RTI) file for viewing. The file is read-only. You may not edit RTI files, but you may create one by selecting an entry in the Board Selection list and clicking on the button Save as RTI. Or you may define a board configuration in the Specify Parameters dialog and then save the information in an RTI file. Details follow.

## Specify Parameters

This is where you may define the parameters of a controller for later use in targetless compilations.

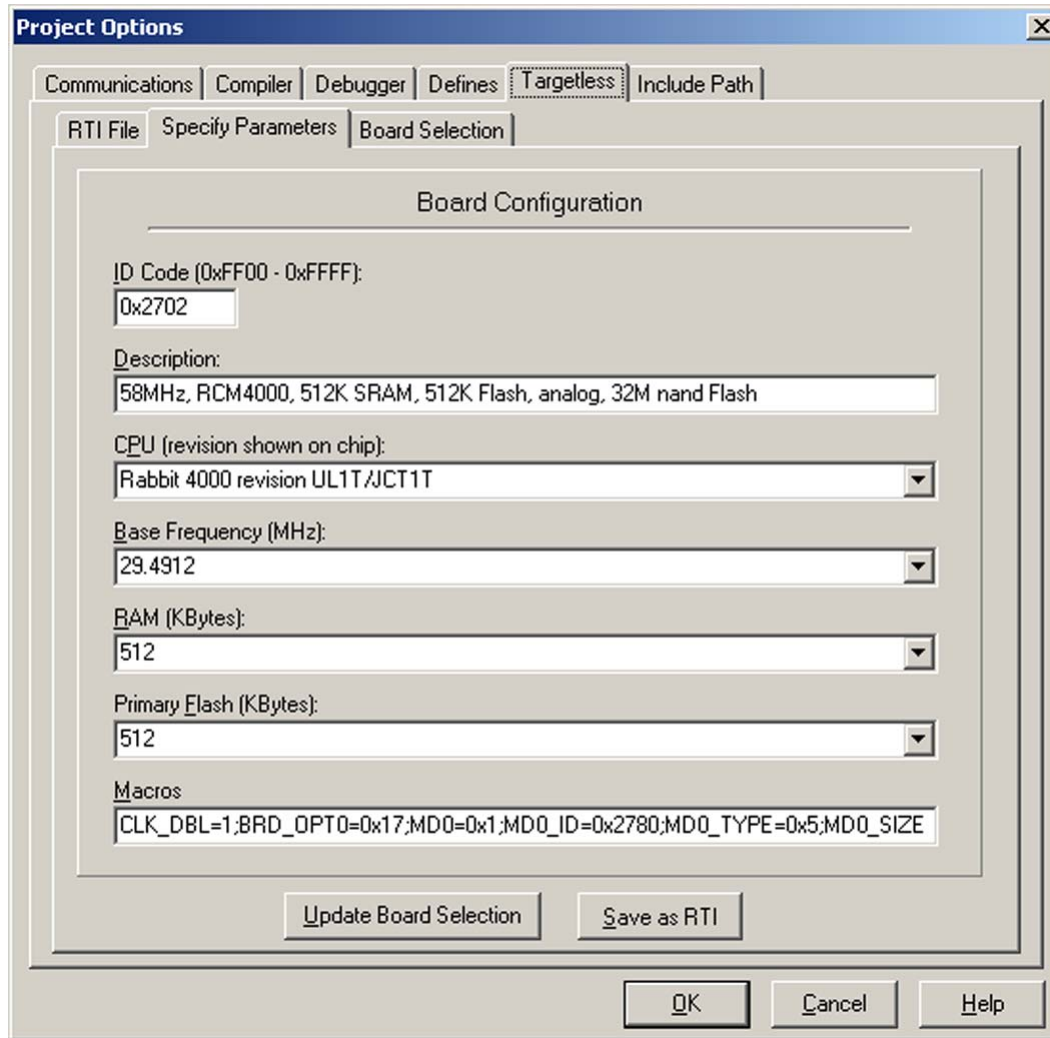

The term “Primary Flash” refers to the Flash device connected to /CS0, not the total amount of Flash available on the board.

The result may be saved to a RTI file for later use, or the result may be saved to the list of board configurations. User defined ID codes are in the form 0xFFnn.

## Board Selection

The list of board configurations is viewable from the Board Selection tab. The highlighted entry in the list of board configurations is the one that will be used when the compilation uses a defined target configuration, that is, when the Default Compile Mode on the Compiler tab is set to “Compile defined target configuration to .bin file” and “Compile” or “Compile to .bin file” is chosen from the Compile menu.

If you save to the list of board configurations by clicking on the button labeled “Update Board Selection” on the Specify Parameters tab, then you must fill in all fields of the dialog. The

baud rate, calculated from the value labeled “Base Frequency (MHz),” only applies to debugging. The fastest baud rate for downloading is negotiated between the PC and the target.

To save to an RTI file only requires an entry in the CPU field.

The correct choice for the CPU field is found on the chip itself. The information is printed on the second line from the top on both the Rabbit 4000 and 5000. The table below lists the possible values for these chips.

| Rabbit Microprocessor | non-RoHS | RoHS        |
|-----------------------|----------|-------------|
| Rabbit 4000           | n/a      | UL#T, JCT#T |
| Rabbit 5000           | n/a      | JZ#T        |

Where “#” is the revision number and the letters are associated information.

### 16.7.2.6 Include Path Tab

Dynamic C 10.60 introduced the standard C feature of #include. With the Include Path tab, you can tell Dynamic C what paths to search for include files as seen in the following dialog.

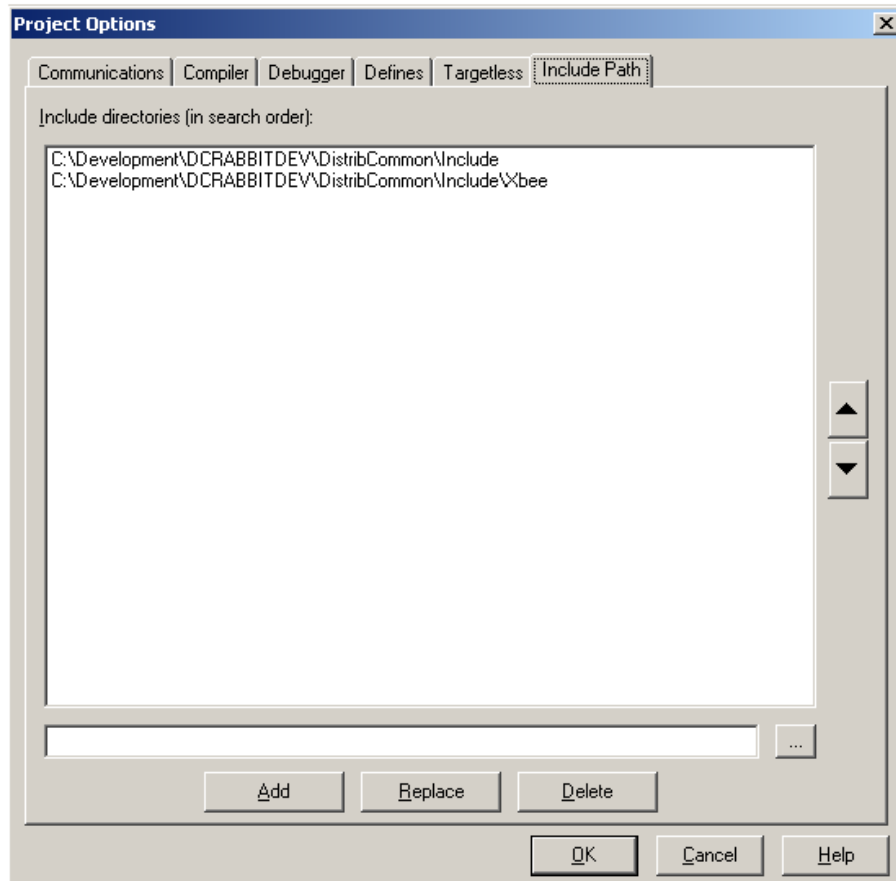

To add a directory to the Include directories, you can either type it directly into the text field at the bottom of the dialog, or you can press the “...” button which will bring up a dialog that

allows you to select the directory through a file browser interface. Pressing "Add" will then add your new directory to the list.

You can also edit directories that are already in the list by first selecting the directory and then using either the "Replace" or "Delete" buttons. "Replace" will replace the currently selected Include directory with the text in the bottom text field. "Delete" will remove the currently selected Include directory from the list.

The arrow buttons at the right allow the ordering of paths to be changed - select a path in the list and move it up or down with the arrows to change the search order (the top item being the first path searched).

**NOTE:** The include paths are unrelated to LIB.DIR and #use. They are only used by #include.

### 16.7.3 Toolbars

Selecting this menu item reveals a list of all menu button groups, i.e., the groups of icons that appear in toolbars beneath the title bar and the main menu items (File, Edit, ...). This area is called the control bar. To remove the control bar from the Dynamic C window, uncheck "View Menu Buttons." Any undocked toolbars (i.e., toolbars floating off the control bar) will still be visible. You undock a toolbar by placing the cursor on the two vertical lines on the left side of the toolbar and dragging it off the control bar.

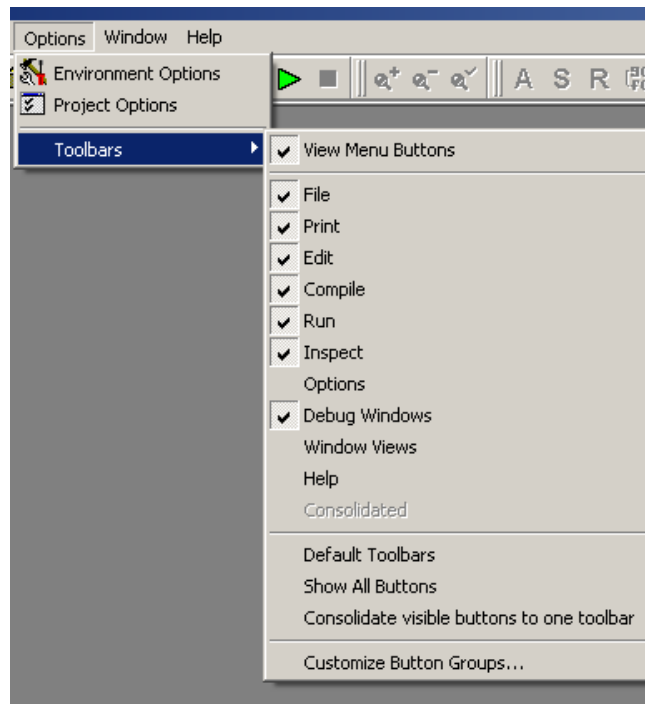

Each menu button group (File, Edit, Compile, Run, Options, Watch, Debug Window, WindowView and Help) has a checkbox for choosing whether to make its toolbar visible on the control bar.

To quickly return to showing only the icons visible by default, select "Default Toolbars."

Select the option, "Consolidate visible buttons to one toolbar" to do exactly that—create one toolbar containing all visible icons. Doing that, enables the option Consolidated, which toggles the visibility of the consolidated toolbar, even when it is undocked from the control bar.

Select “Customize Button Groups” to bring up the Customize Menu Buttons window. This window allows you to change which buttons are associated with which button group on the toolbar.

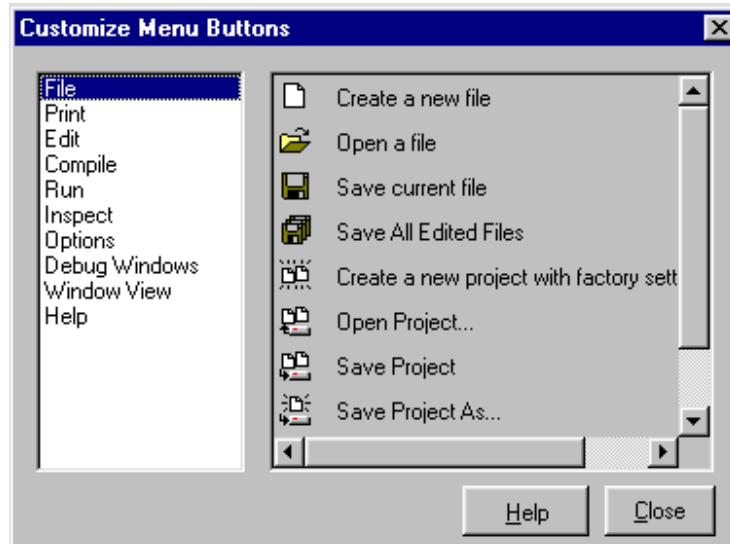

Choose a button group on the left side of the window; this causes the icons for the buttons in that group to display on the right side of the window. Click and drag an icon from the right side of the window to the desired button group on the toolbar.

To remove an icon from its button group, click and drag the icon off the toolbar or to another button group on the toolbar. The Customize Menu Buttons window must be open to change the position of an icon on the toolbar.

## 16.8 Window Menu

Click the menu title or press <Alt+W> to display the Window menu.

You can choose to minimize, restore or close all open windows or just the open debug window or just the open editor windows. The second group of items is a set of standard Windows commands that allow the application windows to be arranged in an orderly way.

The Compiler Messages option is a toggle for displaying that window. This is only available if an error or warning occurred during compilation.

### Project Explorer

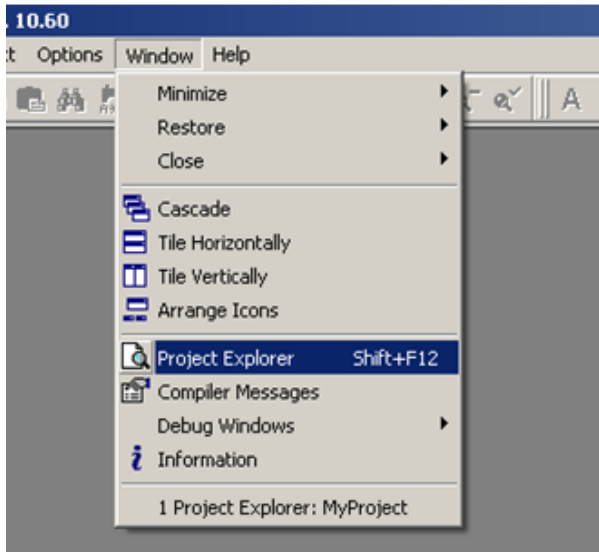

Starting with Dynamic C 10.60, you can organize your projects using multiple .c files as is common with most C development tools. Dynamic C 10.60 introduces an interface to support this new functionality called the Project Explorer. To access the Project Explorer window, click on “Window->Project Explorer” or use the keyboard shortcut <Shift + F12>.

The Project Explorer window serves as your primary project interface for managing and compiling projects with multiple .c files. The project is defined as a list of .c files that will be linked into the final executable BIN file and sent to the target. A "main file" (the top node in the file tree) is specified as the primary application source code. The main file is treated as the first compiled file and will usually include the main function. Note that this is an addition to the project functionality that exists in previous versions.

**NOTE:** Dynamic C .LIB files **should not** be added to the project explorer file list.

Creating a new project or creating a project out of an old Dynamic C application is easy:

- Create your primary application .c source file (if it does not already exist) and save it
- Open the Project Explorer window
- Click “Add Files”
- Select all C files that are part of your project and click "Open"
- If your main file isn't at the top, right click on it and select "Set as Main File"
- Your new project is ready to run!

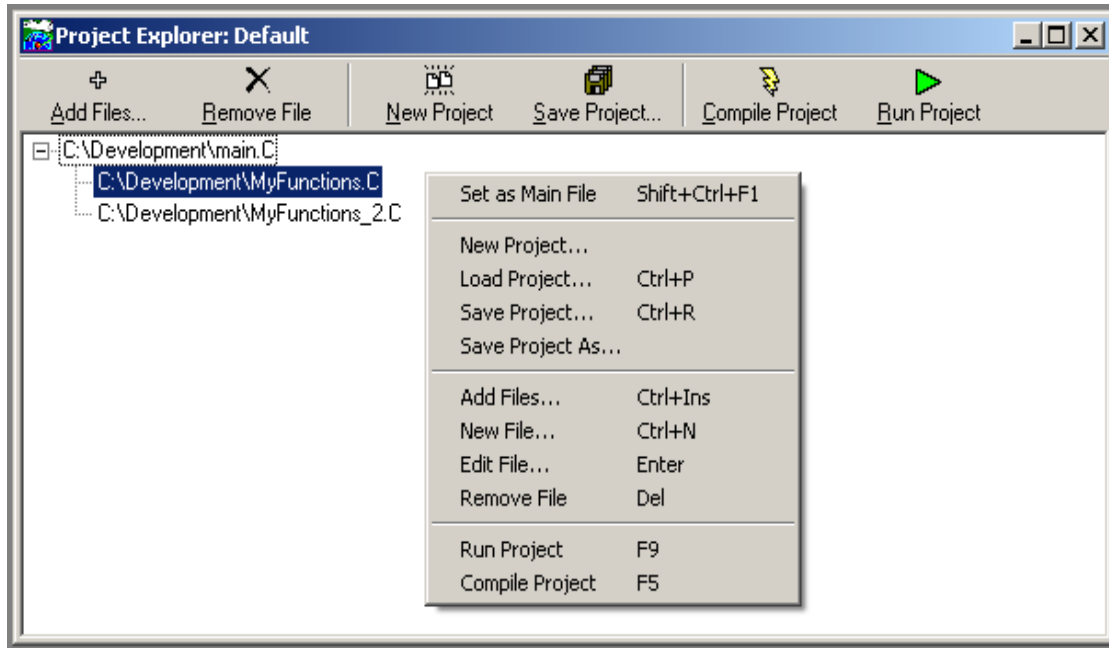

Across the top of the Project Explorer window is a toolbar consisting of commonly-used operations. The full list of new project operations can be accessed through the right-click menu. The operations of the project menu are summarized in the table below.

**Table 16-1. List of Project Explorer Commands**

| Command          | Function                                                                                          | Hot key                              |
|------------------|---------------------------------------------------------------------------------------------------|--------------------------------------|
| Set as Main File | Indicates that the currently selected C file is the primary application source file               | Shift+Ctrl+F1                        |
| New Project      | Create a new project (closes current project)                                                     |                                      |
| Load Project     | Load a previously saved project (closes current project)                                          | Ctrl+P                               |
| Save Project     | Saves currently loaded project                                                                    | Ctrl+R                               |
| Save Project As  | Saves currently loaded project with a new name                                                    |                                      |
| Add Files        | Adds existing files to the project list (file must be created separately)                         | Ctrl+Ins                             |
| New File         | Creates a new .c file, opening a new editor window (file must be added to the project separately) | Ctrl+N                               |
| Edit File        | Opens the currently selected file for editing (you can also double-click on a file in the list)   | Enter                                |
| Remove File      | Removes the currently selected file from the project list (does NOT delete the file)              | Del                                  |
| Run Project      | Compile, download, and run the current project on the attached target                             | F9 (when Project Explorer has focus) |
| Compile Project  | Compile and download the current project to the attached target                                   | F5 (when Project Explorer has focus) |

## Compiling Projects

Pressing F5 with the Project Explorer window in focus compiles the entire project. Similarly, F9 runs the entire project. Without the Project Explorer window in focus, Dynamic C functions exactly as previous versions - F5 compiles the current file in focus and F9 runs it.

There are also a few additional menu items to facilitate compilation of projects. There are targeted compile options for Flash/RAM and compiling to BIN file in addition to a Compile Project option, which is the same as the operation accessible through the Project Explorer window. There is also a Run Project option under the Run menu which can be used to run the currently loaded project at any time."

## Debug Windows

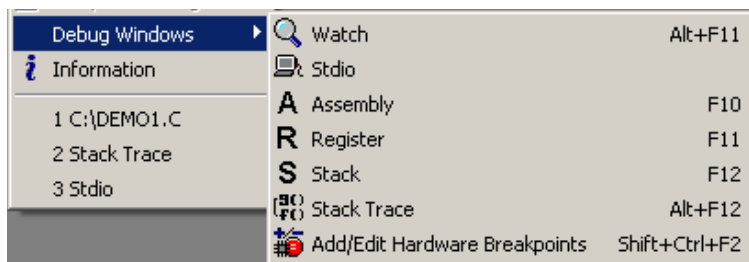

The Debug Windows option opens a secondary menu, whose items are toggles for displaying the like-named debug windows. You can scroll these windows to view larger portions of data, or copy information from these windows and paste the information as text anywhere. More information is given below for each window.

At the bottom of the Window menu is a list of current windows, including source code windows. Click on one of these items to bring its window to the front, i.e., make it the active window.

### Watch

Select Watch to activate or deactivate the Watches window. The Add Watch command on the Inspect menu will do this too. The Watches window displays watch expressions whenever Dynamic C evaluates watch expressions. A watch expression for a structure will automatically include all members of the structure. Previous versions of Dynamic C required each struct member to be added as a separate watch expression.

Keep in mind that when single stepping in assembly, the value of the watch expression may not be valid for variables located on the stack (all auto variables). This is because the debug kernel does not keep track of the pushes and pops that occur on the stack, and since watches of stack variables only make sense in the context of the pushes and pops that have happened, they will not always be accurate when assembly code is being single stepped.

### Stdio

Select this option to activate or deactivate the Stdio window. The Stdio window displays output from calls to `printf ( )`. If the program calls `printf ( )`, Dynamic C will activate the Stdio window automatically if it is not already open, unless "Automatic open" is unchecked in the Debug Windows dialog in Options | Environment Options.

The various Find commands available on the Edit menu can be used directly in the Stdio window.

## Assembly (F10)

Select this option to activate or deactivate the Disassembled Code window. The Disassembled Code window (aka., the Assembly window) displays machine code generated by the compiler in assembly language format.

The “Disassemble at Cursor” or “Disassemble at Address” commands from the Inspect menu also activate the Disassembled Code window.

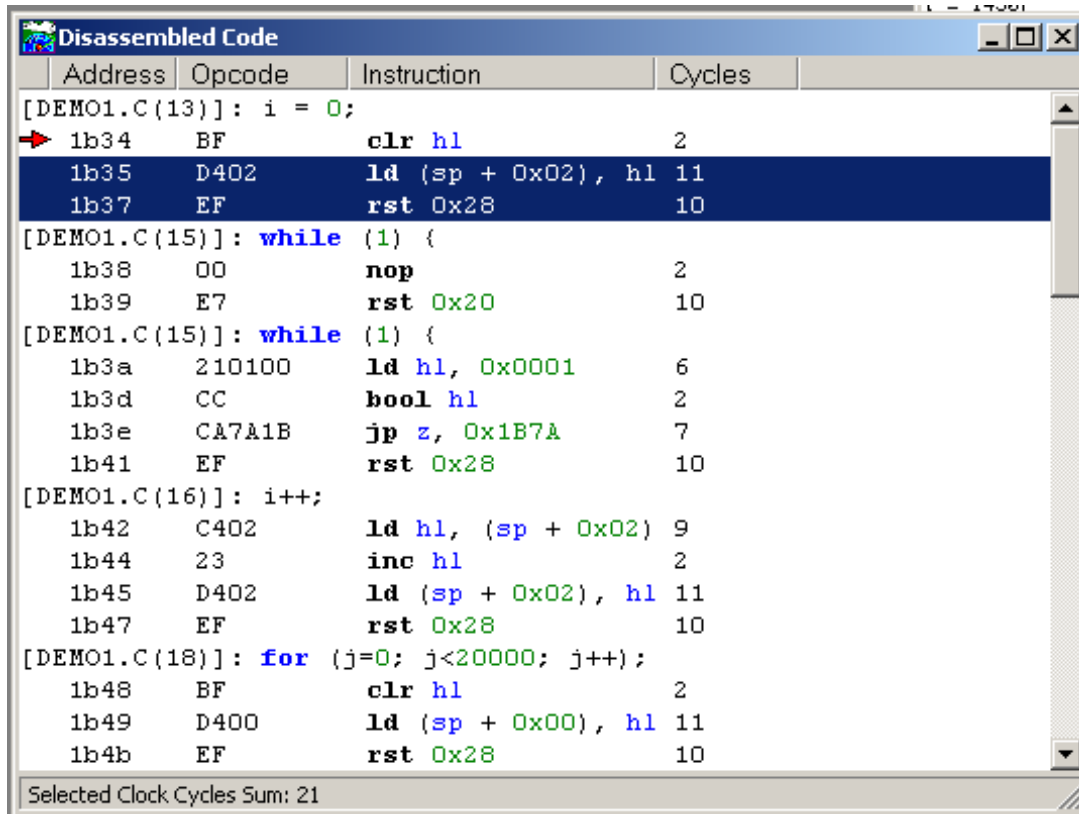

The screenshot shows a window titled "Disassembled Code" with a table of assembly instructions. The table has four columns: Address, Opcode, Instruction, and Cycles. The instructions are grouped by C statements. A red arrow points to the first instruction, and a blue highlight covers the instructions from 1b35 to 1b37. The total cycle count for the selected block is 21.

| Address                                 | Opcode | Instruction        | Cycles |
|-----------------------------------------|--------|--------------------|--------|
| [DEMO1.C(13)]: i = 0;                   |        |                    |        |
| 1b34                                    | BF     | clr hl             | 2      |
| 1b35                                    | D402   | ld (sp + 0x02), hl | 11     |
| 1b37                                    | EF     | rst 0x28           | 10     |
| [DEMO1.C(15)]: while (1) {              |        |                    |        |
| 1b38                                    | 00     | nop                | 2      |
| 1b39                                    | E7     | rst 0x20           | 10     |
| [DEMO1.C(15)]: while (1) {              |        |                    |        |
| 1b3a                                    | 210100 | ld hl, 0x0001      | 6      |
| 1b3d                                    | CC     | bool hl            | 2      |
| 1b3e                                    | CA7A1B | jp z, 0x1B7A       | 7      |
| 1b41                                    | EF     | rst 0x28           | 10     |
| [DEMO1.C(16)]: i++;                     |        |                    |        |
| 1b42                                    | C402   | ld hl, (sp + 0x02) | 9      |
| 1b44                                    | 23     | inc hl             | 2      |
| 1b45                                    | D402   | ld (sp + 0x02), hl | 11     |
| 1b47                                    | EF     | rst 0x28           | 10     |
| [DEMO1.C(18)]: for (j=0; j<20000; j++); |        |                    |        |
| 1b48                                    | BF     | clr hl             | 2      |
| 1b49                                    | D400   | ld (sp + 0x00), hl | 11     |
| 1b4b                                    | EF     | rst 0x28           | 10     |
| Selected Clock Cycles Sum: 21           |        |                    |        |

The Disassembled Code window displays Dynamic C statements followed by the assembly instructions for that statement. Each instruction is represented by the memory address on the far left, followed by the opcode bytes, followed by the mnemonics for the instruction. The last column shows the number of cycles for the instruction, assuming no wait states. The total cycle time for a block of instructions will be shown at the lowest row in the block in the cycle-time column, if that block is selected and highlighted with the mouse. The total assumes one execution per instruction, so the user must take looping and branching into consideration when evaluating execution times.

Use the mouse to select several lines in the Assembly window, and the total cycle time for the instructions that were selected will be displayed to the lower right of the selection. If the total includes an asterisk, that means an instruction with an indeterminate cycle time was selected, such as `ldir` or `ret nz`.

Right click anywhere in the Disassembled Code window to display the following popup menu:

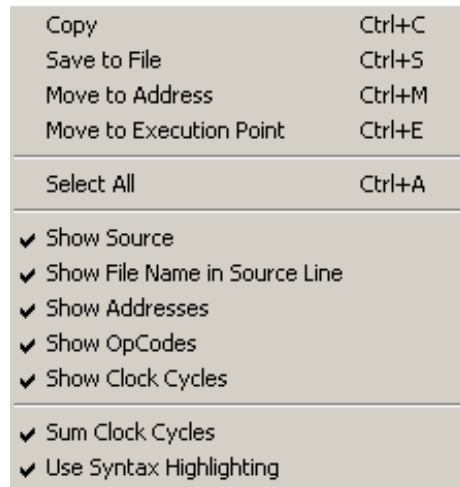

### **Copy**

Copies selected text in the Disassembled Code window to the clipboard.

### **Save to File**

Opens the Save As dialog to save text selected in the Disassembled Code window to a file. If you do not specify an extension, `.dasm` will be appended to the file name.

### **Move to Address**

Opens the Disassemble at Address dialog so you can enter a new address.

### **Move to Execution Point**

Highlights the assembly instruction that will execute next and displays it in the Disassembled Code window.

### **Select ALL**

Selects all text in the Disassembled Code window.

All but the last menu option of the remaining items in the popup menu toggle what is displayed in the Disassembled Code window. The last menu option, “Use Syntax Highlighting,” displays the colors that were set for the editor window in the Disassembled Code window.

To resize a column in the assembly window, move the mouse pointer to one of the vertical bars that is between each of the column headers. For instance, if you move the mouse pointer between “Address” and “Opcode” the pointer will change from an arrow to a vertical bar with arrows pointing to the right and left. Hold the left mouse button down and drag to the right or left to grow or shrink the column.

## Register (F11)

Select this option to activate or deactivate the Register window. This window displays the processor register set, including the status register. Letter codes indicate the bits of the status register (also known as the flags register). The window also shows the source-code line and column at which the snapshot of the register was taken.

It is possible to scroll back to see the progression of successive register snapshots. Register values may be changed when program execution is stopped. Registers PC, XPC, and SP may not be edited as this can adversely affect program flow and debugging.

See “[Register Window](#)” on page 275 for more details on this window.

## Stack (F12)

Select this option to activate or deactivate the Stack window. The Stack window displays the top 32 bytes of the run-time stack. It also shows the line and column at which the stack “snapshot” was taken. It is possible to scroll back to see the progression of successive stack snapshots.

Each time you single step in C or assembly, changed data can be highlighted in the Stack window. (This is also true for the Memory Dump and Register windows.)

## Stack Trace (Ctrl+T)

The Stack Trace window displays the call sequence and the values of function arguments and local variables of the currently running program. The screenshot shown here is the Stack Trace window when `Samples/Demo3.c` is running. The window contents tell us that the function `main()` has been called and that it has one local variable named `secs`, which currently has a value of 0.

The Depth value along the bottom of the Stack Trace window is the current number of bytes on the stack. The Max Depth value is the maximum number of bytes pushed on the stack at any one time for the current run of the program or since the Max Depth value was reset. The Max Depth value can be reset by a right click in the Stack Trace window to bring up some menu options. Along with resetting the Max Depth value back to zero (think of it like a car trip odometer) you can use the right click menu to copy text from the Stack Trace window or to cause the source code file to become the active window. The source code file could be a library file if a library function is executing at the time the menu option is requested.

## Information

Select this option to activate the Information window, which displays how the memory is partitioned and how well the compilation went.

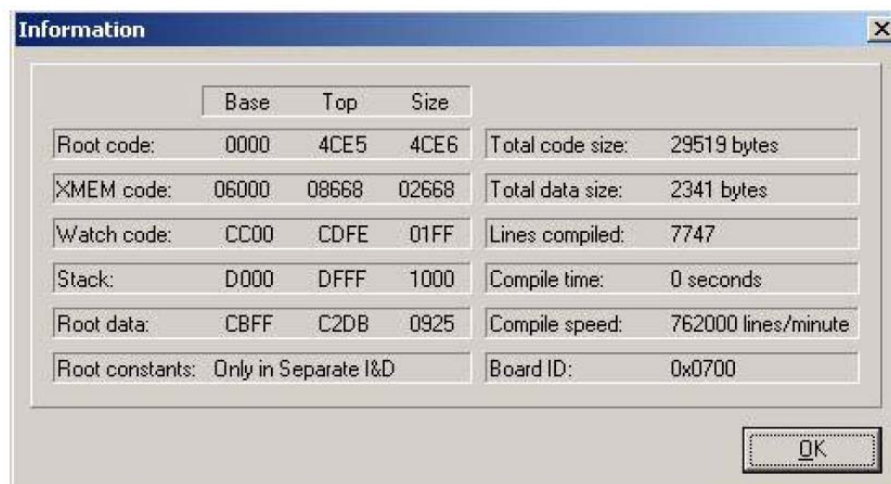

**Table 16-2. Information Window**

| Name of Field   | Description of Field                                                                                      |
|-----------------|-----------------------------------------------------------------------------------------------------------|
| Root code       | The begin (base), end (top) and size of the root code area, expressed in logical address format (16-bit). |
| XMEM code       | The begin, end and size of the XMEM code area, expressed in physical address format (20-bit).             |
| Watch code      | The begin, end and size of the watch code area, expressed in logical address format (16-bit).             |
| Stack           | The begin, end and size of the run-time stack, expressed in logical address format (16-bit).              |
| Root data       | The begin, end and size of the root data area, expressed in logical address format (16-bit).              |
| Root constants  | The begin, end and size of the root constant area, expressed in physical address format (20-bit).         |
| Total code size | The number of code bytes (including both root and XMEM code areas).                                       |
| Total data size | The number of data bytes (including both root and XMEM data areas).                                       |
| Lines compiled  | The number of lines compiled, including lines from library files.                                         |
| Compile time    | The number of seconds taken to compile the program.                                                       |
| Compile speed   | Average speed of compilation measured in lines compiled per minute.                                       |
| Board ID        | A number identifying the board type. A list of board types is at <code>\Lib\default.h</code> .            |

Note that some of the memory areas described here may be non-contiguous (e.g., 2 Flash compiles and the XMEM code area with separate I&D). If an application is large enough to span into the non-contiguous part of an area, the values presented in the Information window for that area are not accurate.

## 16.9 Help Menu

Click the menu title or press <Alt+H> to select the HELP menu. The choices are given below:

### Online Documentation

Opens a browser page and displays a file with links to other manuals. When installing Dynamic C from CD, this menu item points to the hard disk; after a Web upgrade of Dynamic C, this menu item optionally points to the Web.

### Function Lookup <Ctrl+H>

Displays descriptions for library functions. The keyboard shortcut is <Ctrl+H>.

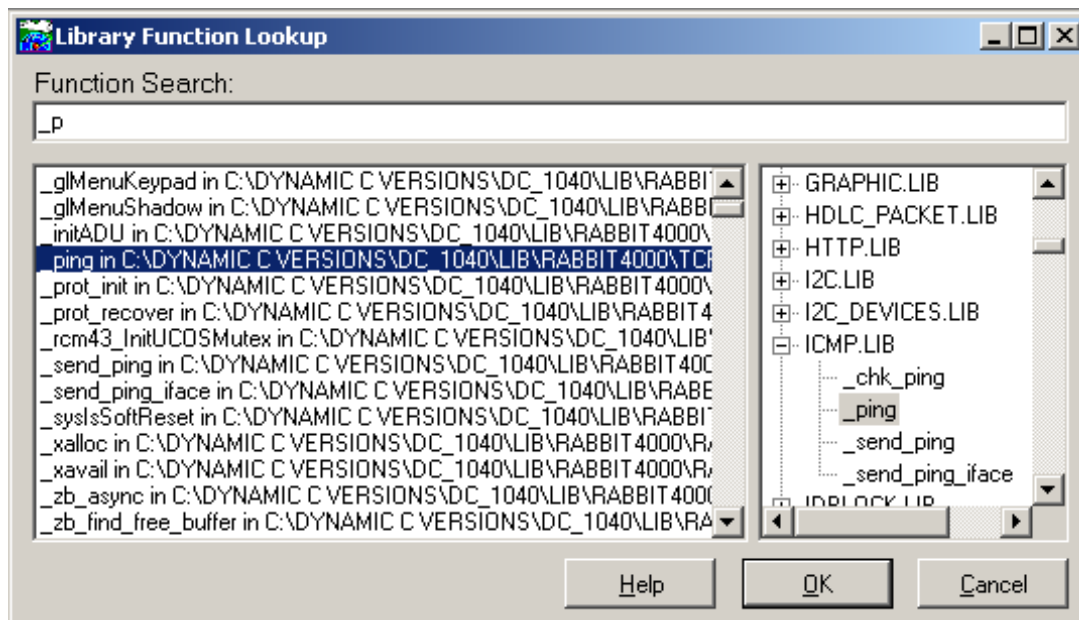

Choosing a function is done in one of several ways. You may type the function name in the Function Search entry box. Notice how both scroll areas underneath the entry box display the first function that matches what you type. The functions to the left are listed alphabetically, while those on the right are arranged in a tree format, displaying the libraries alphabetically with their functions collapsed underneath. You may scroll either of these two areas and have whatever you select in one area reflected in the other area and in the text entry box. Click OK or press <Enter> to bring up the Function Description window.

If the cursor is on a function when Help | Function Lookup is selected (or when <Ctrl+H> is pressed) then the Library Function Lookup dialog is skipped and the Function Description window appears directly.

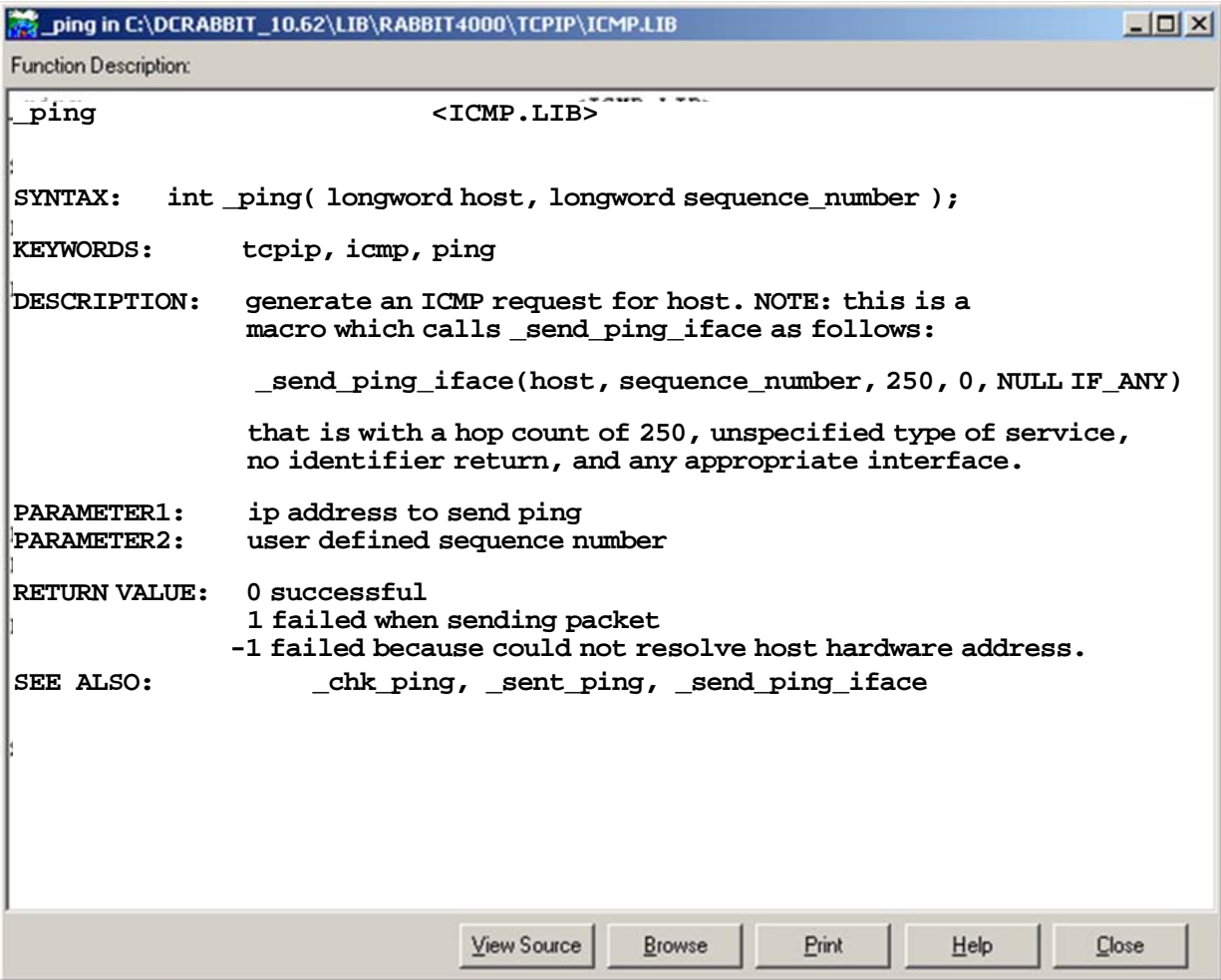

If you click the View Source button, the Function Description window will close and the library that contains the function that was in the window will open in an editor window. The cursor will be placed at the function description of interest.

Clicking on the Browse button will open the Library Function Lookup window to allow you to search for a new function description. Multiple Function Description windows may be open at the same time.

**Instruction Set Reference <Alt+F1>**

Invokes an on-line help system and displays the alphabetical list of instructions for the Rabbit family of microprocessors.

**I/O Registers**

Invokes an on-line help system that provides the bit values for all of the Rabbit I/O registers.

**Keystrokes**

Invokes an on-line help system and displays the keystrokes page. Although a mouse or other pointing device may be convenient, Dynamic C also supports operation entirely from the keyboard.

**Contents**

Invokes an on-line help system and displays the contents page. From here view explanations of various features of Dynamic C.

**Tech Support**

Opens a browser window to the Rabbit Technical Support Center web page, which contains links to user forums, downloads for Dynamic C and information about 3rd party software vendors and developers.

**Register Dynamic C**

Allows you to register your copy of Dynamic C. A dialog is opened for entering your Dynamic C serial number. From there you will be guided through the very quick registration process.

**Tip of the Day**

Brings up a window displaying some useful information about Dynamic C. There is an option to scroll to another screen of Dynamic C information and an option to disable the feature. This is the same window that is displayed when Dynamic C initializes.

**About**

The About command displays the Dynamic C version number and the registered serial number.

# 17. COMMAND LINE INTERFACE

The Dynamic C command line compiler (`dccl_cmp.exe`) performs the same compilation and program execution as its GUI counterpart (`dcrabxx.exe`), but is invoked as a console application from a DOS window. It is called with a single source file program pathname as the first parameter, followed by optional case-insensitive switches that alter the default conditions under which the program is run. The results of the compilation and execution, all errors, warnings and program output, are directed to the console window and are optionally written or appended to a text file.

Note that the command line compiler resides in the directory where you installed Dynamic C. In the console window, you need to "cd" into the directory where the command line compiler resides. From there you must type in the relative path of the sample you want to compile. Quotes are need if there are spaces in the path. For example,

```
> cd c:\DCRabbit_10.40
> dccl_cmp samples\memory_usage.c
> dccl_cmp "c:\My Documents\my program.c"
```

## 17.1 Default States

The command line compiler uses the values of the environment variables that are in the project file indicated by the **-pf** switch, or if the **-pf** switch is not used, the values are taken from `default.dcp`. For more information, please see [Chapter 18, "Project Files" on page 322](#).

The command line compiler will compile and run the specified source file. The exception to this is when the project file "Default Compile Mode" is one of the options which compiles to a `.bin` file, in which case the command line compiler will not run the program but will only compile the source to a `.bin` file. Command line help displayed to the console with

```
dccl_cmp
```

gives a summary of switches with defaults from the default project file, `default.dcp`, and

```
dccl_cmp -pf specified_project_name.dcp
```

gives a summary of switches with defaults from the specified project file. All project options including the default compile mode can be overridden with the switches described in [Section 17.4](#).

## 17.2 User Input

Applications requiring user input must be called with the **-i** option:

```
dccl_cmp myProgram.c -i myProgramInputs.txt
```

where `myProgramInputs.txt` is a text file containing the inputs as separate lines, in the order in which `myProgram.c` expects them.

## 17.3 Saving Output to a File

The output consists of all program printf's as well as all error and warning messages.

Output to a file can be accomplished with the **-o** option

```
dccl_cmp myProgram.c -i myProgramInputs.txt -o myOutputs.txt
```

where `myOutputs.txt` is overwritten if it exists or is created if it does not exist.

If the **-oa** option is used, `myOutputs.txt` is appended if it exists or is created if it does not.

## 17.4 Command Line Switches

Each switch must be separated from the others on the command line with at least one space or tab. Extra spaces or tabs are ignored. The parameter(s) required by some switches must be added as separate text immediately following the switch. Any of the parameters requiring a pathname, including the source file pathname, can have imbedded spaces by enclosing the pathname in quotes.

### 17.4.1 Switches Without Parameters

#### **-b**

|                         |                                                                                                                                               |
|-------------------------|-----------------------------------------------------------------------------------------------------------------------------------------------|
| <b>Description:</b>     | Use compile mode: Compile to .bin file using attached target.                                                                                 |
| <b>Factory Default:</b> | Compile mode: Compile to attached target.                                                                                                     |
| <b>GUI Equivalent:</b>  | Compile program (F5) with Default Compile Mode set to "Compile to .bin file using attached target" in Compiler tab of Project Options dialog. |

#### **-bf-**

|                         |                                                                                                                                                                                              |
|-------------------------|----------------------------------------------------------------------------------------------------------------------------------------------------------------------------------------------|
| <b>Description:</b>     | Undo user-defined BIOS file specification.                                                                                                                                                   |
| <b>Factory Default:</b> | None.                                                                                                                                                                                        |
| <b>GUI Equivalent:</b>  | This is an advanced setting, viewable by clicking on the "Advanced" radio button at the bottom of the Compiler tab of Project Options dialog. Uncheck the "User Defined BIOS File" checkbox. |

#### **-br**

|                         |                                                                                                                                                      |
|-------------------------|------------------------------------------------------------------------------------------------------------------------------------------------------|
| <b>Description:</b>     | Use compile mode: Compile defined target configuration to .bin file                                                                                  |
| <b>Factory Default:</b> | Compile mode: Compile to attached target.                                                                                                            |
| <b>GUI Equivalent:</b>  | Compile program (F5) with Default Compile Mode set to "Compile defined target configuration to .bin file" in Compiler tab of Project Options dialog. |

## **-d+**

**Description:** Enable automatic detection of internal RAM.  
**Factory Default:** Internal RAM will be automatically detected.  
**GUI Equivalent:** None.

## **-d-**

**Description:** Disable automatic detection of internal RAM. Set to false only for Rabbit 4000 CPUs.  
**Factory Default:** Internal RAM will be automatically detected.  
**GUI Equivalent:** None.

## **-h+**

**Description:** Print program header information.  
**Factory Default:** No header information will be printed.  
**GUI Equivalent:** None.  
**Example:** `dccl_cmp samples\demo1.c -h -o myoutputs.txt`  
Header text preceding output of program:  
\*\*\*\*\*  
4/5/01 2:47:16 PM  
dccl\_cmp.exe, Version 10.40P - English  
samples\demo1.c  
Options: -h+ -o myoutputs.txt  
Program outputs:  
Note: Version information refers to `dcwd.exe` with the same compiler core.

## **-h-**

**Description:** Disable printing of program header information.  
**Factory Default:** No header information will be printed.  
**GUI Equivalent:** None.

## **-id+**

**Description:** Enable separate instruction and data space.  
**Factory Default:** Separate I&D space is disabled.  
**GUI Equivalent:** Check “Separate Instruction & Data Space” in Project Options | Compiler.

## **-id-**

**Description:** Disable separate instruction and data space.  
**Factory Default:** Separate I&D space is disabled.  
**GUI Equivalent:** Uncheck “Separate Instruction & Data Space” in the Project Options | Compiler dialog box.

## **-ini**

**Description:** Generates inline code for `WrPortI()`, `RdPortI()`, `BitWrPortI()` and `BitRdPortI()` if all arguments are constants.  
**Factory Default:** No inline code is generated for these functions.  
**GUI Equivalent:** Check “Inline builtin I/O functions” in the Project Options | Compiler dialog box.

## **-lf-**

**Description:** Undo Library Directory file specification.  
**Factory Default:** No Library Directory file is specified.  
**GUI Equivalent:** This is an advanced setting, viewable by clicking on the “Advanced” radio button at the bottom of the Project Options | Compiler dialog box. Uncheck “User Defined Lib Directory File.”

## **-mf**

**Description:** Memory BIOS setting: Flash.  
**Factory Default:** Memory BIOS setting: Flash.  
**GUI Equivalent:** Select “Code and BIOS in Flash” in the Project Options | Compiler dialog box.

## **-mfr**

**Description:** The BIOS and code are compiled to flash, and then the BIOS copies the flash image to RAM to run the code.  
**Factory Default:** Memory BIOS setting: Flash  
**GUI Equivalent:** Select “Code and BIOS in Flash, Run in RAM” in the Project Options | Compiler dialog box.

## **-mr**

**Description:** Memory BIOS setting: RAM.  
**Factory Default:** Memory BIOS setting: Flash.  
**GUI Equivalent:** Select “Code and BIOS in RAM” in the Project Options | Compiler dialog box.

## **-n**

**Description:** Null compile for errors and warnings without running the program. The program will be downloaded to the target.

**Factory Default:** Program is run.

**GUI Equivalent:** Select Compile | Compile or use the keyboard shortcut <F5>.

## **-r**

**Description:** Use compile mode: Compile to attached target.

**Factory Default:** Compile mode: Compile to attached target.

**GUI Equivalent:** Run program (F9)

## **-rb+**

**Description:** Include BIOS when compiling to a file.

**Factory Default:** BIOS is included if compiling to a file.

**GUI Equivalent:** This is an advanced setting, viewable by clicking on the “Advanced” radio button at the bottom of the Project Options | Compiler dialog box. Check “Include BIOS.”

## **-rb-**

**Description:** Do not include BIOS when compiling to a file.

**Factory Default:** BIOS is included if compiling to a file.

**GUI Equivalent:** This is an advanced setting, viewable by clicking on the “Advanced” radio button at the bottom of the Project Options | Compiler dialog box. Uncheck “Include BIOS.”

## **-rd+**

**Description:** Include debug code when compiling to a file.

**Factory Default:** RST 28 instructions are included

**GUI Equivalent:** This is an advanced setting, viewable by clicking on the “Advanced” radio button at the bottom of the Project Options | Compiler dialog box. Select “Always” or “Auto...” under “Include RST 28 instructions.”

## **-rd-**

**Description:** Do not include debug code when compiling to a file. This option is ignored if not compiling to a file.

**Factory Default:** RST 28 instructions are included.

**GUI Equivalent:** This is an advanced setting, viewable by clicking on the “Advanced” radio button at the bottom of the Project Options | Compiler dialog box. Select “Never, disables debugging” under “Include RST 28 instructions.”

### **-ri+**

**Description:** Enable runtime checking of array indices.  
**Factory Default:** Runtime checking of array indices is performed.  
**GUI Equivalent:** Check “Array Indices” in the Project Options | Compiler dialog box.

### **-ri-**

**Description:** Disable runtime checking of array indices.  
**Factory Default:** Runtime checking of array indices is performed.  
**GUI Equivalent:** Uncheck “Array Indices” in the Project Options | Compiler dialog box.

### **-rp+**

**Description:** Enable runtime checking of pointers.  
**Factory Default:** Runtime checking of pointers is performed.  
**GUI Equivalent:** Check “Pointers” in the Project Options | Compiler dialog box.

### **-rp-**

**Description:** Disable runtime checking of pointers.  
**Factory Default:** Runtime checking of pointers is performed.  
**GUI Equivalent:** Uncheck “Pointers” in the Project Options | Compiler dialog box.

### **-rw+**

**Description:** Restrict watch expressions—may save root code space.  
**Factory Default:** Allow any expressions in watch expressions.  
**GUI Equivalent:** This is an advanced setting, viewable by clicking on the “Advanced” radio button at the bottom of the Project Options | Compiler dialog box. Check “Restrict watch expressions . . .”

### **-rw-**

**Description:** Don’t restrict watch expressions.  
**Factory Default:** Allow any expressions in watch expressions.  
**GUI Equivalent:** This is an advanced setting, viewable by clicking on the “Advanced” radio button at the bottom of the Project Options | Compiler dialog box. Check “Allow any expressions in watch expressions”

## **-sp**

**Description:** Optimize code generation for speed.  
**Factory Default:** Optimize for speed.  
**GUI Equivalent:** Choose “Speed” in the Project Options | Compiler dialog box.

## **-sz**

**Description:** Optimize code generation for size.  
**Factory Default:** Optimize for speed.  
**GUI Equivalent:** Choose “Size” in the Project Options | Compiler dialog box.

## **-td+**

**Description:** Enable type demotion checking.  
**Factory Default:** Type demotion checking is performed.  
**GUI Equivalent:** Check “Demotion” in the Project Options | Compiler dialog box.

## **-td-**

**Description:** Disable type demotion checking.  
**Factory Default:** Type demotion checking is performed.  
**GUI Equivalent:** Uncheck “Demotion” in the Project Options | Compiler dialog box.

## **-tp+**

**Description:** Enable type checking of pointers.  
**Factory Default:** Type checking of pointers is performed.  
**GUI Equivalent:** Check “Pointer” in the Project Options | Compiler dialog box.

## **-tp-**

**Description:** Disable type checking of pointers.  
**Factory Default:** Type checking of pointers is performed.  
**GUI Equivalent:** Uncheck “Pointer” in the Project Options | Compiler dialog box.

## **-tt+**

**Description:** Enable type checking of prototypes.  
**Factory Default:** Type checking of prototypes is performed.  
**GUI Equivalent:** Check “Prototype” in the Project Options | Compiler dialog box.

## **-tt-**

**Description:** Disable type checking of prototypes.  
**Factory Default:** Type checking of prototypes is performed.  
**GUI Equivalent:** Uncheck “Prototype” in the Project Options | Compiler dialog box.

## **-vp+**

**Description:** Verify the processor by enabling a DSR check. This should be disabled if a check of the DSR line is incompatible on your system for any reason.  
**Factory Default:** Processor verification is enabled.  
**GUI Equivalent:** Check “Enable Processor verification” in the Project Options | Communications dialog box.

## **-vp-**

**Description:** Assume a valid processor is connected.  
**Factory Default:** Processor verification is enabled.  
**GUI Equivalent:** Uncheck “Enable Processor verification” in the Project Options | Communications dialog box.

## **-wa**

**Description:** Report all warnings.  
**Factory Default:** All warnings reported.  
**GUI Equivalent:** Select “All” under “Warning Reports” in the Project Options | Compiler dialog box.

## **-wn**

**Description:** Report no warnings.  
**Factory Default:** All warnings reported.  
**GUI Equivalent:** Select “None” under “Warning Reports” in the Project Options | Compiler dialog box.

## **-ws**

**Description:** Report only serious warnings.  
**Factory Default:** All warnings reported.  
**GUI Equivalent:** Select “Serious Only” under “Warning Reports” in the Project Options | Compiler dialog box.

## 17.4.2 Switches Requiring a Parameter

The following switches require one or more parameters.

### -bf BIOSFilePathname

|                         |                                                                                                                                                                                                                                                |
|-------------------------|------------------------------------------------------------------------------------------------------------------------------------------------------------------------------------------------------------------------------------------------|
| <b>Description:</b>     | Compile using a BIOS file found in BIOSFilePathname.                                                                                                                                                                                           |
| <b>Factory Default:</b> | <code>\Bios\RabbitBios.c</code>                                                                                                                                                                                                                |
| <b>GUI Equivalent:</b>  | This is an advanced setting, viewable by clicking on the “Advanced” radio button at the bottom of the Project Options   Compiler dialog box. Check the box under “User Defined BIOS File” and then fill in the pathname for the new BIOS file. |
| <b>Example:</b>         | <code>dccl_cmp myProgram.c -bf MyPath\MyBIOS.lib</code>                                                                                                                                                                                        |

### -clf ColdLoaderFilePathname

|                         |                                                                 |
|-------------------------|-----------------------------------------------------------------|
| <b>Description:</b>     | Compile using cold loader file found in ColdLoaderFilePathname. |
| <b>Factory Default:</b> | <code>\Bios\ColdLoad.bin</code>                                 |
| <b>GUI Equivalent:</b>  | None.                                                           |
| <b>Example:</b>         | <code>dccl_cmp myProgram.c -clf MyPath\MyColdloader.bin</code>  |

### -d MacroDefinition

|                     |                                                                                                                                                                                         |
|---------------------|-----------------------------------------------------------------------------------------------------------------------------------------------------------------------------------------|
| <b>Description:</b> | Define macros and optionally equate to values. The following rules apply and are shown here with examples and equivalent <code>#define</code> form:<br>Separate macros with semicolons. |
|---------------------|-----------------------------------------------------------------------------------------------------------------------------------------------------------------------------------------|

```
dccl_cmp myProgram.c -d DEF1;DEF2
#define DEF1
#define DEF2
```

A defined macro may be equated to text by separating the defined macro from the text with an equal sign (=).

```
dccl_cmp myProgram.c -d DEF1=20;DEF2
#define DEF1 20
#define DEF2
```

Macro definitions enclosed in quotation marks will be interpreted as a single command line parameter.

```
dccl_cmp myProgram.c -d "DEF1=text with spaces;DEF2"
#define DEF1 text with spaces
#define DEF2
```

A backslash preceding a character will be kept except for semicolon, quote and backslash, which keep only the character following the backslash. An escaped semicolon will not be interpreted as a macro separator and an escaped quote will not be interpreted as the quote defining the end of a command line parameter of text.

```
dccl_cmp myProgram.c -d DEF1=statement\;;ESCQUOTE=\\\"
#define DEF1 statement;
#define ESCQUOTE \"
dccl_cmp myProg.c -d "FSTR = \"Temp = %6.2F DEGREES C\n\"
#define FSTR "Temp = %6.2f degrees C\n"
```

|                         |                                              |
|-------------------------|----------------------------------------------|
| <b>Factory Default:</b> | None.                                        |
| <b>GUI Equivalent:</b>  | Select the Defines tab from Project Options. |

## **-d- MacroToUndefine**

**Description:** Undefines a macro that might have been defined in the project file. If a macro is defined in the project file read by the command line compiler and the same macro name is redefined on the command line, the command line definition will generate a warning. A macro previously defined must be undefined with the **-d-** switch before redefining it. Undefining a macro that has not been defined has no consequence and so is always safe although possibly unnecessary. In the example, all compilation settings are taken from the project file specified except that now the macro MAXCHARS was first undefined before being redefined.

**Factory Default:** None.

**GUI Equivalent:** None.

**Example:** `dccl_cmp myProgram.c -pf myproject -d- MAXCHARS -d MAXCHARS=512`

## **-eto EthernetResponseTimeout**

**Description:** Time in milliseconds Dynamic C waits for a response from the target on any retry while trying to establish Ethernet communication.

**Factory Default:** 8000 milliseconds.

**GUI Equivalent:** None.

**Example:** `dccl_cmp myProgram.c -eto 6000`

## **-i InputsFilePathname**

**Description:** Execute a program that requires user input by supplying the input in a text file. Each input required should be entered into the text file exactly as it would be when entered into the Stdio Window in `dcwd.exe`. Extra input is ignored and missing input causes `dccl_cmp` to wait for keyboard input at the command line.

**Factory Default:** None.

**GUI Equivalent:** Using `-i` is like entering inputs into the Stdio Window.

**Example:** `dccl_cmp myProgram.c -i MyInputs.txt`

## **-lf LibrariesFilePathname**

**Description:** Compile using a file found in LibrariesFilePathname which lists all libraries to be made available to your programs.

**Factory Default:** Lib.dir.

**GUI Equivalent:** This is an advanced setting, viewable by clicking on the “Advanced” radio button at the bottom of the Project Options | Compiler dialog box. Check the box under “User Defined Lib Directory File” and then fill in the pathname for the new Lib.dir.

**Example:** `dccl_cmp myProgram.c -lf MyPath\MyLibs.txt`

## **-ne maxNumberOfErrors**

|                         |                                                                                                              |
|-------------------------|--------------------------------------------------------------------------------------------------------------|
| <b>Description:</b>     | Change the maximum number of errors reported.                                                                |
| <b>Factory Default:</b> | A maximum of 10 errors are reported.                                                                         |
| <b>GUI Equivalent:</b>  | Enter the maximum number of errors to report under “Max Shown” in the Project Options   Compiler dialog box. |
| <b>Example:</b>         | Allows up to 25 errors to be reported:<br><code>dccl_cmp myProgram.c -ne 25</code>                           |

## **-nw maxNumberOfWarnings**

|                         |                                                                                                                |
|-------------------------|----------------------------------------------------------------------------------------------------------------|
| <b>Description:</b>     | Change the maximum number of warnings reported.                                                                |
| <b>Factory Default:</b> | A maximum of 10 warnings are reported.                                                                         |
| <b>GUI Equivalent:</b>  | Enter the maximum number of warnings to report under “Max Shown” in the Project Options   Compiler dialog box. |
| <b>Example:</b>         | Allows up to 50 warnings to be reported:<br><code>dccl_cmp myProgram.c -nw 50</code>                           |

## **-o OutputFilePathname**

|                         |                                                                                                                                                                                                                  |
|-------------------------|------------------------------------------------------------------------------------------------------------------------------------------------------------------------------------------------------------------|
| <b>Description:</b>     | Write header information (if specified with <code>-h</code> ) and all program errors, warnings and outputs to a text file. If the text file does not exist it will be created, otherwise it will be overwritten. |
| <b>Factory Default:</b> | None.                                                                                                                                                                                                            |
| <b>GUI Equivalent:</b>  | Go to Option   Environment Options and select the Debug Windows tab. Under “Specific Preferences” select “Stdio” and check “Log to File” under “Options.”                                                        |
| <b>Example</b>          | <code>dccl_cmp myProgram.c -o MyOutput.txt</code><br><code>dccl_cmp myProgram.c -o MyOutput.txt -h</code><br><code>dccl_cmp myProgram.c -h -o MyOutput.txt</code>                                                |

## **-oa OutputFilePathname**

|                         |                                                                                                                                                                                                                |
|-------------------------|----------------------------------------------------------------------------------------------------------------------------------------------------------------------------------------------------------------|
| <b>Description:</b>     | Append header information (if specified with <code>-h</code> ) and all program errors, warnings and outputs to a text file. If the text file does not exist it will be created, otherwise it will be appended. |
| <b>Factory Default:</b> | None.                                                                                                                                                                                                          |
| <b>GUI Equivalent:</b>  | Go to Option   Environment Options and select the Debug Windows tab. Under “Specific Preferences” select “Stdio” and check “Log to File” under “Options,” then check “Append” and specify the filename.        |
| <b>Example</b>          | <code>dccl_cmp myProgram.c -oa MyOutput.txt</code>                                                                                                                                                             |

## **-pbf PilotBIOSFilePathname**

**Description:** Compile using a pilot BIOS found in PilotBIOSFilePathname.  
**Factory Default:** \Bios\Pilot.bin  
**GUI Equivalent:** None.  
**Example:** dccl\_cmp myProgram.c -pbf MyPath\MyPilot.bin

## **-pf projectFilePathname**

**Description:** Specify a project file to read before the command line switches are read. The environment settings are taken from the project file specified with **-pf**, or default.dcp if no other project file is specified. Any switches on the command line, regardless of their position relative to the **-pf** switch, will override the settings from the project file.  
**Factory Default:** The project file default.dcp.  
**GUI Equivalent:** Select File | Project | Open...  
**Example**  
dccl\_cmp myProgram.c -ne 25 -pf myProject.dcp  
dccl\_cmp myProgram.c -ne 25 -pf myProject  
Note: The project file extension, .dcp, may be omitted.

## **-ret Retries**

**Description:** The number of times Dynamic C attempts to establish communication if the given timeout period expires.  
**Factory Default:** 3  
**GUI Equivalent:** None.  
**Example:** dccl\_cmp myProgram.c -ret 5

## **-rf RTIFilePathname**

**Description:** Compile to a .bin file using targetless compilation parameters found in RTIFilePathname. The resulting compiled file will have the same pathname as the source (.c) file being compiled, but with a .bin extension.  
**Factory Default:** None.  
**GUI Equivalent:**  
**Example:**  
dccl\_cmp myProgram.c -rf MyTCparameters.rti  
dccl\_cmp myProgram.c -rf "My Long  
Pathname\MyTCparameters.rti"

## **-rti BoardID:CpuID:CrystalSpeed:RAMSize:FlashSize**

|                         |                                                                                                                                                                                                                                                                                                                                                                                                                                                                                                                                                                                                                                                                                                               |
|-------------------------|---------------------------------------------------------------------------------------------------------------------------------------------------------------------------------------------------------------------------------------------------------------------------------------------------------------------------------------------------------------------------------------------------------------------------------------------------------------------------------------------------------------------------------------------------------------------------------------------------------------------------------------------------------------------------------------------------------------|
| <b>Description:</b>     | Compile to a .bin file using parameters defined in a colon separated format of BoardID:CpuID:CrystalSpeed:RAMSize:FlashSize. The resulting compiled file will have the same pathname as the source (.c) file being compiled, but with a .bin extension.<br>BoardID - Hex integer<br>CpuID - 4000r# or 5000r# where # is the revision number of the CPU:<br>4000r0: corresponds to UL1T/JCT1T<br>5000r0: corresponds to XYZ1T/ABC1T/CBS1T<br>(The file TCData.ini in the root installation directory for Dynamic C identifies all current CPU identifiers.)<br>CrystalSpeed - Base frequency, decimal floating point, in MHz<br>RAMSize - Decimal, in KBytes<br>FlashSize - Primary flash, decimal, in KBytes. |
| <b>Factory Default:</b> | None.                                                                                                                                                                                                                                                                                                                                                                                                                                                                                                                                                                                                                                                                                                         |
| <b>GUI Equivalent:</b>  | Select Options   Project Options   Targetless   Board Selection and choose a board from the list; then select Compile   Compile to .bin File   Compile to Flash                                                                                                                                                                                                                                                                                                                                                                                                                                                                                                                                               |
| <b>Example:</b>         | <pre>dccl_cmp myProgram.c -rti 0x0700:2000r3:11.0592:512:256</pre>                                                                                                                                                                                                                                                                                                                                                                                                                                                                                                                                                                                                                                            |

## **-s Port:Baud:Stopbits**

|                         |                                                                                                                                                                                                                                                                                                                                                                                                  |
|-------------------------|--------------------------------------------------------------------------------------------------------------------------------------------------------------------------------------------------------------------------------------------------------------------------------------------------------------------------------------------------------------------------------------------------|
| <b>Description:</b>     | Use serial transmission with parameters defined in a colon separated format of Port:Baud:Stopbits:BackgroundTx.<br>Port: 1, 2, 3, 4, 5, 6, 7, 8<br>Baud: 110, 150, 300, 600, 1200, 2400, 4800, 9600, 12800, 14400, 19200, 28800, 38400, 57600, 115200, 128000, 230400, 256000<br>Stopbits: 1, 2<br><br>Include all serial parameters in the prescribed format even if only one is being changed. |
| <b>Factory Default:</b> | 1:115200:1:0                                                                                                                                                                                                                                                                                                                                                                                     |
| <b>GUI Equivalent:</b>  | Select the Communications tab of Project Options. Select the “Use Serial Connection” radio button.                                                                                                                                                                                                                                                                                               |
| <b>Example:</b>         | Changing port from default of 1 to 2:<br><pre>dccl_cmp myProgram.c -s 2:115200:1:0</pre>                                                                                                                                                                                                                                                                                                         |

## **-sto SerialResponseTimeout**

|                         |                                                                                                                                  |
|-------------------------|----------------------------------------------------------------------------------------------------------------------------------|
| <b>Description:</b>     | Time in milliseconds Dynamic C waits for a response from the target on any retry while trying to establish serial communication. |
| <b>Factory Default:</b> | 300 ms.                                                                                                                          |
| <b>GUI Equivalent:</b>  | None.                                                                                                                            |
| <b>Example:</b>         | <pre>dccl_cmp myProgram.c -sto 400</pre>                                                                                         |

## 17.5 Examples

The following examples illustrate using multiple command line switches at the same time. If the switches on the command line are contradictory, such as `-mr` and `-mf`, the last switch (read left to right) will be used.

### Example 1

In this example, all current settings of `default.dcp` are used for the compile.

```
dccl_cmp samples\timerb\timerb.c
```

### Example 2

In this example, all settings of `myproject.dcp` are used, except `timer_b.c` is compiled to `timer_b.bin` instead of to the target and warnings or errors are written to `myoutputs.txt`.

```
dccl_cmp samples\timerb\timer_b.c -o myoutputs.txt -b -pf myproject
```

### Example 3

These examples will compile and run `myProgram.c` with the current settings in `default.dcp` but using different defines, displaying up to 50 warnings and capture all output to one file with a header for each run.

```
dccl_cmp myProgram.c -d MAXCOUNT=99 -nw 50 -h -o myOutput.txt
dccl_cmp myProgram.c -d MAXCOUNT=15 -nw 50 -h -oa myOutput.txt
dccl_cmp myProgram.c -d MAXCOUNT=15 -d DEF1 -nw 50 -h -oa myOutput.txt
```

The first run could have used the `-oa` option if `myOutput.txt` were known to not initially exist. `myProgram.c` presumably uses a constant `MAXCOUNT` and contains one or more compiler directives that react to whether or not `DEF1` is defined.

## 17.6 Command Line RFU

There is also a command line version of the RFU. On the command line specify:

```
clRFU SourceFilePathName [options]
```

where `SourceFilePathName` is the path name of the `.bin` file to load to the connected target. The options are as follows:

### -cl ColdLoaderPathName

|                            |                                                                                                                                |
|----------------------------|--------------------------------------------------------------------------------------------------------------------------------|
| <b>Description:</b>        | Select a new initial loader.                                                                                                   |
| <b>Default:</b>            | <code>\bios\coldload.bin</code>                                                                                                |
| <b>RFU GUI Equivalent:</b> | From the Setup   Boot Strap Loaders dialog box, type in a pathname or click on the ellipses radio button to browse for a file. |
| <b>Example:</b>            | <code>clRFU myProgram.bin -cl myInitialLoader.bin</code>                                                                       |

## **-fi Flash.ini PathName**

**Description:** Select a new file that Dynamic C will use to externally define flash.  
**Default:** `flash.ini`  
**RFU GUI Equivalent:** From the “Choose File Locations...” dialog box, visible by selecting Setup | File Locations, type in a pathname or click on the ellipses radio button to browse for a file.  
**Example:** `clRFU myProgram.bin -fi myflash.ini`

## **-pb PilotBiosPathName**

**Description:** Select a new secondary loader.  
**Default:** `\bios\pilot.bin`  
**RFU GUI Equivalent:** From the Setup | Boot Strap Loaders dialog box, type in a pathname or click on the ellipses radio button to browse for a file.  
**Example:** `clRFU myProgram.bin -pb mySecondaryLoader.bin`

## **-s port:baudrate**

**Description:** Select the comm port and baud rate for the serial connection.  
**Default:** COM1 and 115,200 bps  
**RFU GUI Equivalent:** From the Setup | Communications dialog box, choose values from the Baud Rate and Comm Port drop-down menus.  
**Example:** `clRFU myProgram.bin -s 2:115200`

## **-v**

**Description:** Causes the RFU version number and additional status information to be displayed.  
**Default:** Only error messages are displayed.  
**RFU GUI Equivalent:** Status information is displayed by default and there is no option to turn it off.  
**Example:** `clRFU myProgram.bin -v`

## **-vp+**

**Description:** Verify the presence of the processor by using the DSR line of the PC serial connection.  
**Default:** The processor is verified.  
**RFU GUI Equivalent:** From the “Communications Options” dialog box, visible by selecting Setup | Communications, check the “Enable Processor Detection” option.  
**Example:** `clRFU myProgram.bin -vp+`

## **-vp-**

|                            |                                                                                                                                             |
|----------------------------|---------------------------------------------------------------------------------------------------------------------------------------------|
| <b>Description:</b>        | Do not verify the presence of the processor.                                                                                                |
| <b>Default:</b>            | The processor is verified.                                                                                                                  |
| <b>RFU GUI Equivalent:</b> | From the “Communications Options” dialog box, visible by selecting Setup   Communications, uncheck the “Enable Processor Detection” option. |
| <b>Example:</b>            | <code>clRFU myProgram.bin -vp-</code>                                                                                                       |

## **-usb+**

|                            |                                                                                                                                            |
|----------------------------|--------------------------------------------------------------------------------------------------------------------------------------------|
| <b>Description:</b>        | Enable use of USB to serial converter.                                                                                                     |
| <b>Default:</b>            | The use of the USB to serial converter is disabled.                                                                                        |
| <b>RFU GUI Equivalent:</b> | From the “Communications Options” dialog box, visible by selecting Setup   Communications, check the “Use USB to Serial Converter” option. |
| <b>Example:</b>            | <code>clRFU myProgram.bin -usb+</code>                                                                                                     |

## **-usb-**

|                            |                                                                                                                                              |
|----------------------------|----------------------------------------------------------------------------------------------------------------------------------------------|
| <b>Description:</b>        | Disable use of USB to serial converter.                                                                                                      |
| <b>Default:</b>            | The use of the USB to serial converter is disabled.                                                                                          |
| <b>RFU GUI Equivalent:</b> | From the “Communications Options” dialog box, visible by selecting Setup   Communications, uncheck the “Use USB to Serial Converter” option. |
| <b>Example:</b>            | <code>clRFU myProgram.bin -usb-</code>                                                                                                       |

# 18. PROJECT FILES

In Dynamic C, a project is an environment that consists of opened source files, a BIOS file, available libraries, and the conditions under which the source files will be compiled. The File Open directory last used will be stored in the project file<sup>i</sup>. Projects allow different compilation environments to be separately maintained.

## 18.1 Project File Names

A project maintains a compilation environment in a file with the extension `.dcp`.

### 18.1.1 Factory.dcp

The environment originally shipped from the factory is kept in a project file named `factory.dcp`. If Dynamic C cannot find this file, it will be recreated automatically in the Dynamic C exe path. The factory project can be opened at any time and the environment changed and saved to another project name, but `factory.dcp` will not be changed by Dynamic C.

### 18.1.2 Default.dcp

This default project file is originally a copy of `factory.dcp` and will be automatically recreated as such in the exe path if it cannot be found when Dynamic C opens. The default project will automatically become the active project with File | Project... | Close.

The default project is special in that the command line compiler will use it for default values unless another project file is specified with the `-pf` switch, in which case the settings from the indicated project will be used.

Please see [Chapter 17](#) for more details on using the command line compiler.

### 18.1.3 Active Project

Whenever a project is selected, the current project related data is saved to the closing project file, the new project settings become active, and the (possibly new) BIOS will automatically be recompiled prior to compiling a source file in the new environment.

The active project can be `factory.dcp`, `default.dcp` or any project you create with File | Project... | Save As... When Dynamic C opens, it retrieves the last used project, or the default project if being opened for the first time or if the last used project cannot be found.

---

i. If DC is started with a `cwd` (current working directory) other than the exe directory, the `cwd` will be used instead of the one saved in the project file. This can happen if Dynamic C is started from a Windows shortcut with a specified "starts in" directory.

If a project is closed with the File | Projects... | Close menu option, the default project, `default.dcp`, becomes the active project.

The active project file name, without path or extension, is always shown in the leftmost panel of the status bar at the bottom of the Dynamic C main window and is prepended to the Dynamic C version in the title bar except when the active project is the default project.

Changes made to the compilation environment of Dynamic C are automatically updated to the active project, unless the active project is `factory.dcp`.

## 18.2 Updating a Project File

Unless the active project is `factory.dcp`, changes made in the Project Options dialog will cause the active project file to be updated immediately:

Opening or closing files will not immediately update the active project file. The project file state of the recently used files appearing at the bottom of the File menu selection and any opened files in edit windows will only be updated when the project closes or when File | Projects... | Save is selected. The Message, Assembly, Memory Dump, Registers and Stack debug windows are not edit windows and will not be saved in the project file if you exit Dynamic C while debugging.

## 18.3 Menu Selections

The menu selections for project files are available in the File menu. The choices are the familiar ones: Create..., Open..., Save, Save As... and Close.

Choosing File | Project | Open... will bring up a dialog box to select an existing project filename to become the active project. The environment of the previous project is saved to its project file before it is replaced (unless the previous project is `factory.dcp`). The BIOS will automatically be recompiled prior to the compilation of a source file within the new environment, which may have a different library directory file and/or a different BIOS file.

Choosing File | Project... | Save will save the state of the environment to the active project file, including the state of the recently used filelist and any files open in edit windows. This selection is greyed out if the active project is `factory.dcp`. This option is of limited use since any project changes will be updated immediately to the file and the state of the recently used filelist and open edit windows will be updated when the project is closed for any reason.

Choosing File | Project... | Save as... will bring up a dialog box to select a project file name. The file will be created or, if it exists, it will be overwritten with the current environment settings. This environment will also be saved to the active project file before it is closed and its copy (the newly created or overwritten project file) will become active.

Choosing File | Project... | Close first saves the environment to the active project file (unless the active project is `factory.dcp`) and then loads the Dynamic C default project, `default.dcp`, as the active project. As with Open..., the BIOS will automatically be recompiled prior to the compilation of a source file within the new environment. The new environment may have a different library directory file and/or a different BIOS file.

## 18.4 Command Line Usage

When using the command line compiler, `dccl_cmp.exe`, a project file is always read. The default project, `default.dcp`, is used automatically unless the project file switch, `-pf`, specifies another project file to use. The project settings are read by the command line compiler first even if a `-pf` switch comes after the use of other switches, and then all other switches used in the command line are read, which may modify any of the settings specified by the project file.

The default behavior given for each switch in the command line documentation is with reference to the `factory.dcp` settings, so the user must be aware of the default state the command line compiler will actually use. The settings of `default.dcp` can be shown by entering `dccl_cmp` alone on the command line. The defaults for any other project file can be shown by following `dccl_cmp` by a the project file switch without a source file. The command:

```
dccl_cmp
```

shows the current state of all `default.dcp` settings. The command:

```
dccl_cmp -pf myProject
```

shows the current state of all `myProject.dcp` settings. And the command:

```
dccl_cmp myProgram.c -ne 25 -pf myProject
```

reads `myProject.dcp`, then compiles and runs `myProgram.c`, showing a maximum of 25 errors.

The command line compiler, unlike Dynamic C, never updates the project file it uses. Any changes desired to a project file to be used by the command line compiler can be made within Dynamic C or changed by hand with an editor.

Making changes by hand should be done with caution. Use an editor that does not introduce carriage returns or line feeds with wordwrap, which may be a problem if the global defines or any file pathnames are lengthy strings. Be careful to not change any of the section names in brackets or any of the key phrases up to and including the “=”.

If a macro is defined on the command line with the `-d` switch, any value that may have been defined within the project file used will be overwritten without warning or error. undefining a macro with the `-d-` switch has no consequence if it was not previously defined.

# 19. HINTS AND TIPS

This chapter offers hints on how to speed up an application and how to store persistent data at run time.

## 19.1 A User-Defined BIOS

The file `RabbitBIOS.c` is a wrapper that permits a choice of which BIOS to compile. A modular design has many of the configuration macros in separate configuration libraries. The BIOS file and configuration libraries are located in `LIB\BIOSLIB`. [Table 19-1](#) lists the new files and gives a brief description of their content.

**Table 19-1. BIOS File and Configuration Libraries**

| File Name                         | Description                                                                                               |
|-----------------------------------|-----------------------------------------------------------------------------------------------------------|
| <code>STDBIOS.C</code>            | Most of the code from <code>RabbitBIOS.c</code> was moved here.                                           |
| <code>CLONECONFIG.LIB</code>      | Macros for configuring cloning.                                                                           |
| <code>DKCONFIG.LIB</code>         | Macros for configuring the debug kernel                                                                   |
| <code>ERRLOGCONFIG.LIB</code>     | Macros for configuring non-RabbitSys error logging. RabbitSys has its own error logging method.           |
| <code>MEMCONFIG.LIB</code>        | Macros for configuring memory organization.                                                               |
| <code>SYSCONFIG.LIB</code>        | Macros for other system-level configuration options, such as the clock doubler and the spectrum spreader. |
| <code>TWOPROGRAMCONFIG.LIB</code> | Macros for configuring split memory for the old-style DLM/DLP.                                            |
| <code>FATCONFIG.LIB</code>        | Macros for configuring the FAT file system.                                                               |

To create a user-defined BIOS, begin with a copy of `STDBIOS.C` to modify. It is prudent to save `STDBIOS.C` as is and rename the modified file.

The Dynamic C GUI offers an option for hooking a user-defined BIOS into the system. See the description of the “[Advanced... Button](#)” for details on using this GUI option. You will need to consider the configuration files and associated macros described in [Table 19-1](#).

## 19.2 Efficiency

There are a number of methods that can be used to reduce the size of a program, or to increase its speed. Let's look at the events that occur when a program enters a function.

- The function saves `IX` on the stack and makes `IX` the stack frame reference pointer (if the program is in the `useix` mode).
- The function creates stack space for `auto` variables.
- The function sets up stack corruption checks if stack checking is enabled (`on`).
- The program notifies Dynamic C of the entry to the function so that single stepping modes can be resolved (if in debug mode).

The last two consume significant execution time and are eliminated when stack checking is disabled or if the debug mode is off.

### 19.2.1 Nodebug Keyword

When the PC is connected to a target controller with Dynamic C running, the normal code and debugging features are enabled. Dynamic C places an `RST 28H` instruction at the beginning of each C statement to provide locations for breakpoints. This allows the programmer to single step through the program or to set breakpoints. (It is possible to single step through assembly code at any time.) During debugging there is additional overhead for entry and exit bookkeeping, and for checking array bounds, stack corruption, and pointer stores. These “jumps” to the debugger consume one byte of code space and also require execution time for each statement.

At some point, the Dynamic C program will be debugged and can run on the target controller without the Dynamic C debugger. This saves on overhead when the program is executing. The `nodebug` keyword is used in the function declaration to remove the extra debugging instructions and checks.

```
nodebug int myfunc(int x, int z){
 ...
}
```

If programs are executing on the target controller with the debugging instructions present but without Dynamic C attached, the call to the function that handles `RST 28H` instructions in the vector table will be treated as a `NOP` by the processor when in debug mode. The target controller will work, but its performance will not be as good as when the `nodebug` keyword is used.

If the `nodebug` option is used for the `main( )` function, the program will begin to execute as soon as it finishes compiling (as long as the program is not compiling to a file).

Use the directive `#nodebug` anywhere within the program to enable `nodebug` for all statements following the directive. The `#debug` directive has the opposite effect.

Assembly code blocks are `nodebug` by default, even when they occur inside C functions that are marked `debug`, therefore using the `nodebug` keyword with the `#asm` directive is usually unnecessary.

## 19.2.2 In-line I/O

The built-in I/O functions (`WrPortI()`, `RdPortI()`, `BitWrPortI()` and `BitRdPortI()`) can be generated as efficient in-line code instead of function calls. All arguments must be constant. A normal function call is generated if the I/O function is called with any non-constant arguments. To enable in-line code generation for the built-in I/O functions check the option “Inline builtin I/O functions” in the Compiler dialog, which is accessible by clicking the Compiler tab in the Project Options dialog.

## 19.3 Run-time Storage of Data

Data that will never change in a program can be put in flash by initializing it in the declarations. The compiler will put this data in flash. See the description of the `const`, `xdata`, and `xstring` keywords for more information.

If data must be stored at run-time and persist between power cycles, there are several ways to do this using Dynamic C functions:

- **User Block** - Recommended method for storing non-file data. Factory-stored calibration constants live in the User block for boards with analog I/O. Space here is limited to as small as  $(8K - \text{sizeof}(\text{SysIDBlock}))$  bytes, or less if there are calibration constants. For specific information about the User block on your board, open the sample programs `userblock_info.c` and/or `idblock_report.c`. The latter program will print, among other things, the location of the User block.
- **WriteFlash2** - This function is provided for writing arbitrary amounts of data directly to arbitrary addresses in the second flash.
- **Battery-Backed RAM** - Storing data here is as easy as assigning values to global variables or local static variables. The file system can also be configured to use RAM.

The life of a battery on a Rabbit board is specified in the user’s manual for that board; some boards have batteries that last several years, most board have batteries that come close to or surpass the shelf-life of the battery. If it is important that battery-backed data not be lost during a power failure, know how long your battery will last and plan accordingly.

### 19.3.1 User Block

The User block is an area near the top of flash reserved for run-time storage of persistent data and calibration constants. The size of the User block can be read in the global structure member `SysIDBlock.userBlockSize`. The functions `readUserBlock()` and `writeUserBlock()` are used to access the User block. These function take an offset into the block as a parameter. The highest offset available to the user in the User block will be

```
SysIDBlock.userBlockSize-1
```

if there are no calibration constants, or

```
DAC_CALIB_ADDR-1
```

if there are.

See the Rabbit designer’s handbook for more details about the User block.

## 19.3.2 WriteFlash2

See the *Dynamic C Function Reference Manual* for a complete description of `WriteFlash2()`.

There is a function available for writing to the first flash, `WriteFlash()`, but its use is highly discouraged for reasons of forward source and binary compatibility should flash sector configuration change drastically in a product. For more information on flash compatibility issues, see technical notes TN216 “Is your Application Ready for Large Sector Flash?” and TN217 “Binary and Source Compatibility Issues for 4K Flash Sector Sizes” at Rabbit’s website: [rabbit.com](http://rabbit.com).

## 19.3.3 Battery-Backed RAM

Static variables and global variables will always be located at the same addresses between power cycles and can only change locations via recompilation. The file system can be configured to use RAM also. While there may be applications where storing persistent data in RAM is acceptable, for example a data logger where the data gets retrieved and the battery checked periodically, keep in mind that a programming error such as an uninitialized pointer could cause RAM data to be corrupted.

`xalloc()` will allocate blocks of RAM in extended memory. It will allocate the blocks consistently from the same physical address if done at the beginning of the program and the program is not recompiled.

## 19.4 Root Memory Reduction Tips

Customers with programs that are near the limits of root code and/or root data space usage will be interested in these tips for saving root space. For more help, see Technical Note TN238 “Rabbit Memory Usage Tips.” This document is available by choosing Online Documentation from the Help menu of Dynamic C or at at: [rabbit.com](http://rabbit.com).

### 19.4.1 Increasing Root Code Space

Increasing the available amount of root code space may be done in the following ways:

- **Enable Separate Instruction and Data Space**

A hardware memory management scheme that uses address line inversion to double the amount of logical address space in the base and data segments is enabled on the Compiler tab of the Options | Project Options dialog. Enabling separate I&D space doubles the amount of root code and root data available for an application program.

- **Use `#memmap xmem`**

This will cause C functions that are not explicitly declared as “root” to be placed in `xmem`. Note that the only reason to locate a C function in root is because it modifies the XPC register (in embedded assembly code), or it is an ISR. The only performance difference in running code in `xmem` is in getting there and returning. It takes a total of 12 additional machine cycles because of the differences between `call/lcall`, and `ret/lret`.

- **Increase `ROOT_SIZE_4K`<sup>i</sup>**

The macro `ROOT_SIZE_4K` determines the beginning logical address for the data segment.

---

i. The macro `DATAORG` was deprecated in favor of `ROOT_SIZE_4K` starting with Dynamic C 10.21. `ROOT_SIZE_4K` equals `DATAORG/0x1000`.

Root code space can be increased by increasing `ROOT_SIZE_4K` in `StdBIOS.c`. The default is `0x3` when separate I&D space is on, and `0x6` otherwise. It can be as high as `0xB`.

When separate I&D space is on, `ROOT_SIZE_4K` defines the boundary between root variable data and root constant data. In this case, increasing `ROOT_SIZE_4K` increases root constant space and decreases root variable space.

When separate I&D space is off, `ROOT_SIZE_4K` determines the boundary between root variable data and the combination of root code and root constant data. Note that root constants are in the base segment with root code. In this case, increasing `ROOT_SIZE_4K` increases root code and root constant space and decreases root data space.

- **Compile out floating point support**

Floating point support can be conditionally compiled out of `stdio.lib` by adding `#define STDIO_DISABLE_FLOATS` to either a user program or the Defines tab page in the Project Options dialog. This can save several thousand bytes of code space.

- **Reduce usage of root constants and string literals**

Shortening literal strings and reusing them will save root space. The compiler automatically reuses identical string literals.

These two statements :

```
printf ("This is a literal string");
sprintf (buf, "This is a literal string");
```

will share the same literal string space whereas:

```
sprintf (buf, "this is a literal string");
```

will use its own space since the string is different.

- **Use the far keyword to directly declare variables in xmem**

See [Section 4.3](#) and [Chapter 14](#) for more information on the far keyword.

- **Turn off selected debugging features**

Watch expressions, breakpoints, and single stepping can be selectively disabled on the Debugger tab of Project Options to save some root code space.

- **Place assembly language code into xmem**

Pure assembly language code functions can go into xmem.

```
#asm
foo_root::
 [some instructions]
 ret
#endasm
```

The same function in xmem:

```
#asm xmem
foo_xmem::
 [some instructions]
 lret ; use lret instead of ret
#endasm
```

The correct calls are `call foo_root` and `lcall foo_xmem`. If the assembly function modifies the XPC register with

```
LD XPC, A
```

it should not be placed in `xmem`. If it accesses data on the stack directly, the data will be one byte away from where it would be with a `root` function because `lcall` pushes the value of XPC onto the stack.

## 19.4.2 Increasing Root Data Space

Increasing the available amount of root data space may be done in the following ways:

- **Enable Separate Instruction and Data Space**

A hardware memory management scheme that uses address line inversion to double the amount of logical address space in the base and data segments is enabled on the Compiler tab of the Options | Project Options dialog. Enabling separate I&D space doubles the amount of root code and root data available for an application program.

- **Decrease `ROOT_SIZE_4K`<sup>i</sup>**

The macro `ROOT_SIZE_4K` determines the beginning logical address for the data segment.

Root data space can be increased by decreasing `ROOT_SIZE_4K` in `StdBIOS.c`. At the time of this writing, RAM compiles should be done with no less than the default value (0x6) of `DATAORG` when separate I&D space is off. This restriction is to ensure that the pilot BIOS does not overwrite itself.

When separate I&D space is on, `ROOT_SIZE_4K` determines the boundary between root variable data and root constant data. In this case, decreasing `ROOT_SIZE_4K` increases root variable space and decreases root constant space.

When separate I&D space is off, `ROOT_SIZE_4K` determines the boundary between root variable data and the combination of root code and root constant data. Note that root constants are in the base segment with root code. In this case, decreasing `ROOT_SIZE_4K` increases root data space and decreases root code space.

- **Use `xmem` for large RAM buffers**

`xalloc()` can be used to allocate chunks of RAM in extended memory (`xmem`) but its use is no longer necessary for data objects which exist for the program's lifetime. It is, however, preserved for backwards compatibility.

Using the `far` keyword is easier and more efficient than using `xalloc()`. Consider the following code:

```
far char my_buffer[BUFFER_SIZE];

int main() {
 far char *p;
 p = my_buffer;
 ... // access xmem directly
}
```

Large buffers used by Dynamic C libraries are already allocated from RAM in `xmem`.

---

i. The macro `DATAORG` was deprecated in favor of `ROOT_SIZE_4K` starting with Dynamic C 10.21. `ROOT_SIZE_4K` equals `DATAORG/0x1000`.

# APPENDIX A. MACROS AND GLOBAL VARIABLES

This appendix contains descriptions of macros and global variables available in Dynamic C. This is not an exhaustive list.

## A.1 Macros Defined by the Compiler

The macros in the following table are defined internally. Default values are given where applicable, as well as directions for changing values.

**Table 20-1. Macros Defined by the Compiler**

| Macro Name                | Definition and Default                                                                                                                                                                                                                                                                                                                                                                                                      |
|---------------------------|-----------------------------------------------------------------------------------------------------------------------------------------------------------------------------------------------------------------------------------------------------------------------------------------------------------------------------------------------------------------------------------------------------------------------------|
| <code>_BIOSBAUD_</code>   | This is the debug baud rate. The baud rate can be changed in the Communications tab of Project Options.                                                                                                                                                                                                                                                                                                                     |
| <code>_BOARD_TYPE_</code> | This is read from the System ID block or defaulted to 0x100 (the BL1810 JackRabbit board) if no System ID block is present. This can be used for conditional compilation based on board type. Board types are listed in <code>boardtypes.lib</code> .                                                                                                                                                                       |
| <code>_CPU_ID_</code>     | This macro identifies the CPU type, including its revision; e.g.,<br><pre>#if _CPU_ID_ &gt;= R4000_R0</pre> identifies a Rabbit 4000 microprocessor.<br>Look in <code>\Lib\.\BIOSLIB\sysiodefs.lib</code> for the constants and mask macros that are defined for use with <code>_CPU_ID_</code> .                                                                                                                           |
| <code>CC_VER</code>       | Gives the Dynamic C version in hex, i.e., if Dynamic C version 10.40 is being used, the value of <code>CC_VER</code> will be 0x0A40.                                                                                                                                                                                                                                                                                        |
| <code>DC_CRC_PTR</code>   | Reserved.                                                                                                                                                                                                                                                                                                                                                                                                                   |
| <code>__DATE__</code>     | The compiler substitutes this macro with the date that the file was compiled (either the BIOS or the <code>.c</code> file). The character string literal is of the form <code>Mmm dd yyyy</code> . The text used for the months is as follows: "Jan," "Feb," "Mar," "Apr," "May," "Jun," "Jul," "Aug," "Sep," "Oct," "Nov," "Dec." There is a space as the first character of <code>dd</code> if the value is less than 10. |
| <code>DEBUG_RST</code>    | Go to the Compiler tab of Project Options and click on the "Advanced" button at the bottom of the dialog box. Check "Include RST 28 instructions" to set <code>DEBUG_RST</code> to 1. Debug code will be included even if <code>#nodebug</code> precedes the main function in the program.                                                                                                                                  |

**Table 20-1. Macros Defined by the Compiler**

| Macro Name                          | Definition and Default                                                                                                                                                                                                       |
|-------------------------------------|------------------------------------------------------------------------------------------------------------------------------------------------------------------------------------------------------------------------------|
| <code>__FILE__</code>               | The compiler substitutes this macro with the current source code file name as a character string literal.                                                                                                                    |
| <code>__LINE__</code>               | The compiler substitutes this macro with the current source code line number as a decimal constant.                                                                                                                          |
| <code>NO_BIOS</code>                | Boolean value. Tells the compiler whether or not to include the BIOS when compiling to a .bin file. This is an advanced compiler option accessible by clicking the “Advanced” button on the Compiler tab in Project Options. |
| <code>__TARGETLESS_COMPILE__</code> | Boolean value. It defaults to 0. Set it by selecting “Compile defined target configuration to .bin file” under “Default Compile Mode,” in the Compiler tab of Project Options.                                               |
| <code>__TIME__</code>               | The compiler substitutes this macro with the time that the file (BIOS or .c) was compiled. The character string literal is of the form <code>hh:mm:ss</code> .                                                               |

## A.2 Macros Defined in the BIOS or Configuration Libraries

This is not a comprehensive list of configuration macros, but rather, a short list of those found to be commonly used by Dynamic C programmers. Most default conditions can be overridden by defining the macro in the “Defines” tab of the “Project Options” dialog.

All the configuration macros listed here were defined in `RabbitBIOS.c` prior to Dynamic C 9.30. Since then many of them have been moved to configuration libraries while `RabbitBIOS.c` has become a wrapper file that permits a choice of which BIOS to compile. See [Section 19.1](#) for more information on the reorganization of the BIOS that occurred with Dynamic C 9.30.

### **CLOCK\_DOUBLED**

Determines whether or not to use the clock doubler. The default condition is to use the clock doubler, defined in `\BIOSLIB\sysconfig.lib`. Override the default condition by defining `CLOCK_DOUBLED` to “0” in an application or in the project.

### **ROOT\_SIZE\_4K**

Defines the beginning logical address for the data segment. Defaults are defined in the BIOS: 0x3 if separate I&D space enabled, 0x6 otherwise. Users can override the defaults in the Defines tab of Project Options dialog.

### **WATCHCODESIZE**

Specifies the number of root RAM bytes for watch code. Defaults are defined in the BIOS: 0x200 bytes if watch expressions are enabled, zero bytes otherwise. The defaults cannot be overridden by an application.

### **USE\_TIMER\_A\_PRESCALE**

Uncomment this macro in `\BIOSLIB\sysconfig.c` to run the peripheral clock at the same frequency as the CPU clock instead of the standard “CPU clock/2.”

## A.3 Global Variables

These variables may be read by any Dynamic C application program.

### **dc\_timestamp**

This internally-defined long is the number of seconds that have passed since 00:00:00 January 1, 1980, Greenwich Mean Time (GMT) adjusted by the current time zone and daylight savings of the PC on which the program was compiled. The recorded time indicates when the program finished compiling. The following program will use `dc_timestamp` to help calculate the date and time.

```
printf("The date and time: %lx\n", dc_timestamp);

main(){
 struct tm t;
 printf("dc_timestamp = %lx\n", dc_timestamp);
 mktime(&t, dc_timestamp);

 printf("%2d/%02d/%4d %02d:%02d:%02d\n",
 t.tm_mon,t.tm_mday,t.tm_year + 1900, t.tm_hour,t.tm_min,
 t.tm_sec);
}
```

### **OPMODE**

This is a char. It can have the following values:

- 0x88 = debug mode
- 0x80 = run mode

### **SEC\_TIMER**

This unsigned long variable is initialized to the value of the real-time clock (RTC). If the RTC is set correctly, this is the number of seconds that have elapsed since the reference date of January 1, 1980. The periodic interrupt updates `SEC_TIMER` every second. This variable is initialized by the Virtual Driver when a program starts.

### **MS\_TIMER**

This unsigned long variable is initialized to zero. The periodic interrupt updates `MS_TIMER` every millisecond. This variable is initialized by the Virtual Driver when a program starts.

### **TICK\_TIMER**

This unsigned long variable is initialized to zero. The periodic interrupt updates `TICK_TIMER` 1024 times per second. This variable is initialized by the Virtual Driver when a program starts.

## A.4 Exception Types

These macros are defined in `errors.lib`:

|                                           |     |
|-------------------------------------------|-----|
| <code>#define ERR_BADPOINTER</code>       | 228 |
| <code>#define ERR_BADARRAYINDEX</code>    | 229 |
| <code>#define ERR_DOMAIN</code>           | 234 |
| <code>#define ERR_RANGE</code>            | 235 |
| <code>#define ERR_FLOATOVERFLOW</code>    | 236 |
| <code>#define ERR_LONGDIVBYZERO</code>    | 237 |
| <code>#define ERR_LONGZEROMODULUS</code>  | 238 |
| <code>#define ERR_BADPARAMETER</code>     | 239 |
| <code>#define ERR_INTDIVBYZERO</code>     | 240 |
| <code>#define ERR_UNEXPECTEDINTRPT</code> | 241 |
| <code>#define ERR_CORRUPTEDCODATA</code>  | 243 |
| <code>#define ERR_VIRTWDOGTIMEOUT</code>  | 244 |
| <code>#define ERR_BADXALLOC</code>        | 245 |
| <code>#define ERR_BADSTACKALLOC</code>    | 246 |
| <code>#define ERR_BADSTACKDEALLOC</code>  | 247 |
| <code>#define ERR_BADXALLOCINIT</code>    | 249 |
| <code>#define ERR_NOVIRTWDOGAVAIL</code>  | 250 |
| <code>#define ERR_INVALIDMACADDR</code>   | 251 |
| <code>#define ERR_INVALIDCOFUNC</code>    | 252 |

## A.5 Rabbit Registers

Macros are defined for all of the Rabbit registers that are accessible for application programming. A list of these register macros can be found in the user's manuals for the Rabbit microprocessor, as well as in the Rabbit Registers file accessible from the Dynamic C Help menu.

### A.5.1 Shadow Registers

Shadow registers exist for many of the I/O registers. They are character variables defined in the BIOS. The naming convention for shadow registers is to append the word `Shadow` to the name of the register. For example, the global control status register, `GCSR`, has a corresponding shadow register named `GCSRShadow`.

The purpose of the shadow registers is to allow the program to reference the last value programmed to the actual register. This is needed because a number of the registers are write only.

## APPENDIX B. MAP FILE GENERATION

All symbol information is put into a single file. The map file has three sections: a memory map section, a function section, and a globals section.

The map file format is designed to be easy to read, but with parsing in mind for use in program down-loaders and in other possible future utilities (for example, an independent debugger). Also, the memory map, as defined by the `#org` statements, will be saved into the map file.

Map files are generated in the same directory as the file that is compiled. If compilation is not successful, the contents of the map file are not reliable.

### B.1 Grammar

`<mapfile>`: `<memmap section>` `<function section>` `<global section>`

`<memmap section>`: `<memmapreg>`+

`<memmapreg>`: `<register var>` = `<8-bit const>`

`<register var>`: `XPC|SEGSIZE|DATASEG`

`<function section>`: `<function description>`+

`<function description>`: `<identifier>` `<address>` `<size>`

`<address>`: `<logical address>` | `<physical address>`

`<logical address>`: `<16-bit constant>`

`<physical address>`: `<8-bit constant>`:`<16-bit constant>`

`<size>`: `<20-bit constant>`

`<global section>`: `<global description>`+

`<global description>`: `<scoped name>` `<address>`

`<scoped name>`: `<global>`| `<local static>`

`<global>`: `<identifier>`

`<local static>`: `<identifier>`:`<identifier>`

Comments are C++ style (`//` only).

# APPENDIX C. SECURITY SOFTWARE & UTILITY PROGRAMS

This appendix documents several useful and easy to use utility programs available from Rabbit.

This appendix documents the security software and utility programs available for Rabbit-based systems.

## C.1 Dynamic C Utilities

There are several utilities bundled with Dynamic C.

### C.0.1 Rabbit I/O LIB Utility

This utility is provided for configuring a Rabbit 4000 or 5000 board. All register bit assignments for the Rabbit 4000 and many register bit assignments for the Rabbit 5000 are transformed from cryptic hex numbers into an easy-to-use GUI. You can also open a window that lets you view the corresponding register values as you make changes via the GUI.

Double-click on `/Utilities/IOConfig.exe` to run the utility.

When a configuration is saved, the utility will generate a library that contains a function that will execute the necessary statements to produce the selected configuration. The name of the function and the name and path of the library are chosen by the user in the “Save Configuration” dialog. If the library is saved where your “lib.dir” file can find it, then the newly created function and library can be found with Ctrl+H when running Dynamic C. The utility-generated function and library are used in application code as follows:

```
#use mylib.lib
main(){
 BoardInit();
 ...
}
```

The Rabbit I/O LIB Utility allows you to configure the following Rabbit features:

- Parallel Ports - includes configuring slave port and auxiliary I/O bus use, pin data direction and alternate functions.
- Serial Ports - includes configuring transfer mode, hardware pin assignment for Tx and Rx, baud rate and other serial port parameters.
- PWM - includes configuring the interrupt priority, period, duty cycle, spread function and prescaler for each PWM channel. You can also select parallel port pins for the PWM output.
- Timers - includes configuration of timers A, B and C. Includes configuring interrupt priority.
- External Interrupts - includes configuring priority level and whether interrupts occur on the rising edge, falling edge or both.

- Input Capture - includes configuring priority levels, choosing between normal and counter operation, determining trigger latch, trigger condition pin and start/stop conditions.
- External I/O - includes configuring wait states, signal polarity, selecting type of strobe signals, transaction timing and whether or not to enable handshaking.
- DMA - includes configuring parallel port pin assignments for triggering external DMA requests and transfer mode.
- Quadrature Decoder - includes configuring interrupt priority level, counter width (8 or 10 bits), assigning parallel port pins for quadrature decoder inputs and determining PCLK prescaler and timer A10 divisor.
- Slave Port - includes configuring interrupt priority level, enabling/disabling the slave port and the external I/O bus.

## C.0.2 Library File Encryption

The Library File Encryption Utility, `Encrypt.exe`, allows distribution of sensitive runtime library files.

The encrypted library files compile normally, but cannot be read with an editor. The files will be automatically decrypted during Dynamic C compilation, but users of Dynamic C will not be able to see any of the decrypted contents except for function descriptions for which a public interface is given. An optional user-defined copyright notice is put at the beginning of an encrypted file.

To use this utility, double-click on the program name, `Encrypt.exe`. The following window will appear:

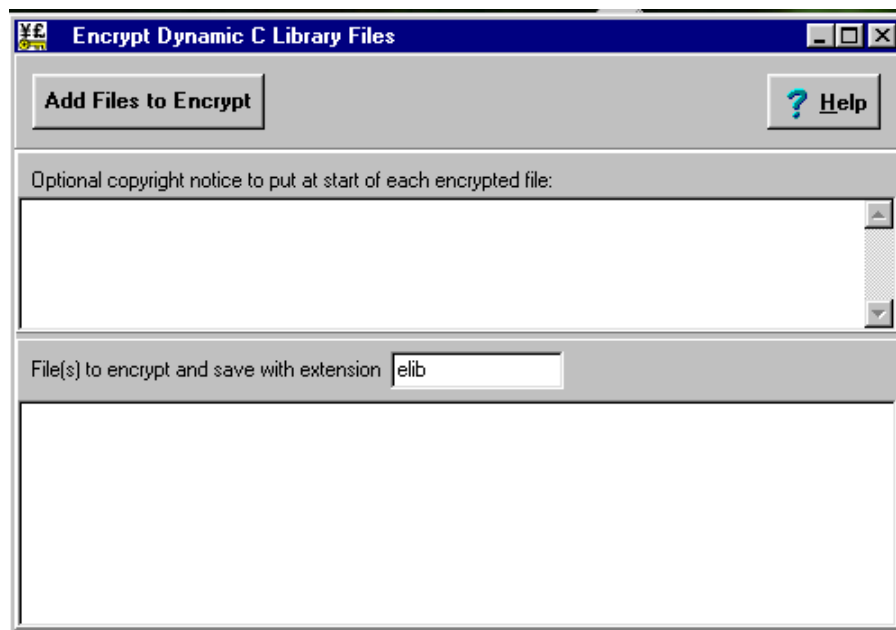

Complete instructions are available by clicking on the Help button in the upper righthand corner of the program window. Context-sensitive help is accessed by positioning the cursor over the desired subject and then pressing <F1>.

### C.0.2.1 Add Files to Encrypt

There are two ways to select files to encrypt.

1. Type the path and filename in the lower window.
2. Click the Add Files to Encrypt button to bring up a file open dialog box and browse for the desired file.

The list of files to be encrypted may be edited if desired. Notice that if anything is entered in the lower window, a new button named “Encrypt” appears. Two entries in the window change it to “Encrypt All”. Clicking this button causes the utility to encrypt the file(s) listed in the lower window.

### C.0.2.2 File Extension

Encrypted files will be saved with the same pathname but with the extension supplied. Dynamic C will use encrypted and non-encrypted files seamlessly, so the choice of extension is for one’s own file management.

### C.0.2.3 Optional Text Area

The upper window is a text window of up to 4k bytes in length. Any text entered will appear in all files in the list appearing in the lower window. If two files are to be given unique headers, they should be encrypted separately.

This area can be used for copyright information, instructions, disclaimers, warnings, or anything else relevant to viewers of the file.

## C.0.3 File Compression Utility

Dynamic C has a compression utility feature. The default utility implements an LZSS style compression algorithm. Support libraries to decompress files achieve a throughput of 10 KB/s to 20 KB/s (number of bytes in uncompressed file/time to decompress entire file using `ReadCompressedFile()`) depending upon file size and compression ratio.

The `#zimport()` compiler directive performs a standard `#ximport`, but compresses the file by invoking the compression utility before emitting the file to the target. Support libraries allow the compressed file to be decompressed on-the-fly. Compression ratios of 50% or more for text files can be achieved, thus freeing up valuable xmem space. The compression library is thread safe.

For details on compression ratios, memory usage and performance, please see Technical Note 234, “File Compression (Using `#zimport`)” available on our website, at [www.rabbit.com](http://www.rabbit.com).

### C.0.3.1 Using the File Compression Utility

The utility is invoked by Dynamic C during compile time when `#zimport` is used. The keyword `#zimport` will compress any file. Of course some files are already in a compressed format, for example jpeg files, so trying to compress them further is not useful and may even cause the resulting compressed file to be larger than the original file. (The original file is not modified by the compression utility nor by the support libraries.) The compression of FS2 files is a special case. Instead of using `#zimport`, `#ximport` is used along with the function `CompressFile()`.

Compressed files are decompressed on-the-fly using `ReadCompressedFile()`. Compressed FS2 files may also be decompressed on-the-fly by using `ReadCompressedFile()`. In addition, an FS2 file may be decompressed into a new FS2 file by using `DecompressFile()`.

There are 3 sample programs to illustrate the use of file compression

- `Samples/zimport/zimport.c`: demonstrates `#zimport`
- `Samples/zimport/zimport_fs2.c`: demonstrates file compression in combination with the file system
- `Samples/tcpip/http/zimport.c`: demonstrates file compression support using the http server

### C.0.3.2 File Compression/Decompression API

The file compression API consists of 7 functions, 3 of which are of prime importance:

`OpenInputCompressedFile()` - open a compressed file for reading or open an uncompressed `#ximport` file for compression.

`CloseInputCompressedFile()` - close input file and deallocate memory buffers.

`ReadCompressedFile()` - perform on-the-fly decompression.

The remaining 4 functions are included for compression support for FS2 files:

`OpenOutputCompressedFile()` - open FS2 file for use with `CompressFile()`.

`CloseOutputCompressedFile()` - close file and deallocate memory buffers.

`CompressFile()` - compress an FS2 file, placing the result in a second FS2 file.

`DecompressFile()` - decompress an FS2 file, placing the result in a second FS2 file.

Complete descriptions are available for these functions in the *Dynamic C Function Reference Manual* and also via the Function Lookup facility (Ctrl+H or Help menu).

There are several macros associated with the file compression utility:

- `ZIMPORT_MASK` - Used to determine if the imported file is compressed (`#zimport`) or not (`#ximport`).
- `OUTPUT_COMPRESSION_BUFFERS` (default = 0) - Number of 24K buffers for compression (compression also requires a 4K input buffer, which is allocated automatically for each output buffer that is defined).
- `INPUT_COMPRESSION_BUFFERS` (default = 1) Number of 4KB internal buffers (in RAM) used for decompression.

Each compressed file has an associated file descriptor of type `ZFILE`. All fields in this structure are used internally and must not be changed by an application program.

### C.0.3.3 Replacing the File Compression Utility

Users can use their own compression utility, replacing the one provided. If the provided compression utility is replaced, the following support libraries will also need to be replaced: `zimport.lib`, `lzss.lib` and `bitio.lib`. They are located in `lib\..\zimport\`. The default compression utility, `Zcompress.exe`, is located in Dynamic C's root directory. The utility name is defined by a key in the current project file:

```
[Compression Utility]
```

```
Zimport External Utility=Zcompress.exe
```

To replace `Zcompress.exe` as the utility used by Dynamic C for compression, open your project file and edit the filename.

The compression utility must reside in the same directory as the Dynamic C compiler executable. Dynamic C expects the program to behave as follows:

- Take as input a file name relative to the Dynamic C installation directory or a fully qualified path.
- Produce an output file of the same name as the input file with the extension `.DCZ` at the end. E.g., `test.txt` becomes `test.txt.dcz`.
- Exit with zero on success, non-zero on failure.

If the utility does not meet these criteria, or does not exist, a compile-time error will be generated.

### C.0.4 Font and Bitmap Converter Utility

The Font and Bitmap Converter converts Windows fonts and monochrome bitmaps to a library file format compatible with Rabbit's Dynamic C applications and graphical displays. Non-Roman characters may also be converted by applying the monochrome bitmap converter to their bitmaps.

Double-click on the `fmbcnvtr.exe` file in the Utilities folder where you installed Dynamic C. Select and convert existing fonts or bitmaps. Complete instructions are available by clicking on the Help button within the utility.

When complete, the converted file is displayed in the editing window. Editing may be done, but probably won't be necessary. Save the file as `name_me.lib`: the name of your choice.

Add the file to applications with the statement:

```
#use name_me.lib // remember to add this filename to "lib.dir" file
```

or by cut and pasting from `name_me.lib` directly into the application file.

### C.0.5 Rabbit Field Utility Module

The Rabbit Field Utility (RFU) will load a binary file created with Dynamic C to a Rabbit-based board. The RFU can be used to load a binary file without Dynamic C present on the host computer, and without recompiling the program each time it is loaded to a controller.

The Dynamic C installation created a desktop icon for the RFU. The executable file, `rfu.exe`, can be found in the subdirectory named "Utilities" where Dynamic C was installed. Complete instructions are available by clicking on the Help button within the utility. The Help document details setup information, the file menu options and BIOS requirements.



The RFU executable that comes with the Dynamic C distribution is branded as a product, as seen in the "About" screenshot shown here. You can brand the RFU or customize its functionality to suit your needs. Please contact technical support for the source file needed for customization:

[www.rabbit.com/support/questionSubmit.shtml](http://www.rabbit.com/support/questionSubmit.shtml)

The RFU enables those without Dynamic C to update their Rabbit-based board with a few files installed on the computer and the appropriate connection to the target board.

The necessary files are included with Dynamic C. They are: the executable (Rfu.exe), the cold loader, the pilot BIOS, and a couple of files used to determine information about the memory device being used.

The default files used for the cold loader, etc., can be seen by selecting “File Locations...” from the Setup menu. We strongly recommend that the default files be used. They are needed internally by the RFU and improper operation of the utility will result if a replacement file does not contain the expected code or information.

Rfu.exe and its ancillary files are freely distributable.

The RFU communicates with the target using a serial connection. This connection requires a programming cable.

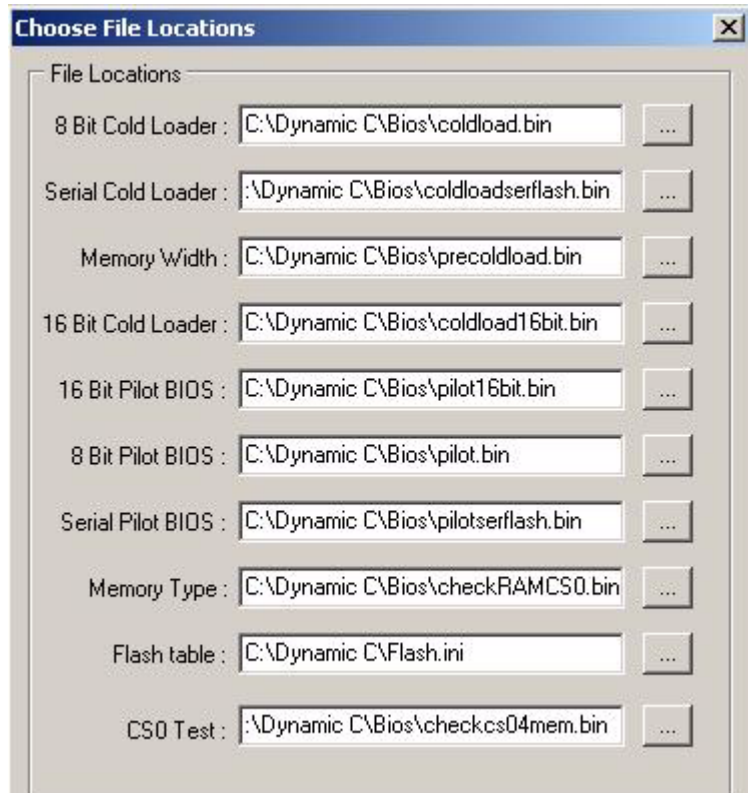

### C.0.5.1 Command Line RFU

There is also a command line version of the RFU. On the command line specify:

```
clRFU SourceFilePathName [options]
```

where SourceFilePathName is the path name of the .bin file to load to the connected target. The options are as follows:

#### -s port:baudrate

- Description:** Select the comm port and baud rate for the serial connection.
- Default:** COM1 and 115,200 bps
- RFU GUI Equivalent:** From the Setup | Communications dialog box, choose values from the Baud Rate and Comm Port drop-down menus.
- Example:** clRFU myProgram.bin -s 2:115200

#### --v

- Description:** Causes the RFU version number and additional status information to be displayed.
- Default:** Only error messages are displayed.
- RFU GUI Equivalent:** Status information is displayed by default and there is no option to turn it off.
- Example:** clRFU myProgram.bin -v

## **-cl ColdLoaderPathName**

|                            |                                                                                                                                                                                              |
|----------------------------|----------------------------------------------------------------------------------------------------------------------------------------------------------------------------------------------|
| <b>Description:</b>        | Select a new initial loader.                                                                                                                                                                 |
| <b>Default:</b>            | <code>\bios\coldload.bin</code>                                                                                                                                                              |
| <b>RFU GUI Equivalent:</b> | From the “Choose File Locations...” dialog box, visible by selecting the menu option Setup   File Locations,, type in a pathname or click on the ellipses radio button to browse for a file. |
| <b>Example:</b>            | <code>clRFU myProgram.bin -cl myInitialLoader.c</code>                                                                                                                                       |

## **-pb PilotBiosPathName**

|                            |                                                                                                                                                                                             |
|----------------------------|---------------------------------------------------------------------------------------------------------------------------------------------------------------------------------------------|
| <b>Description:</b>        | Select a new secondary loader.                                                                                                                                                              |
| <b>Default:</b>            | <code>\bios\pilot.bin</code>                                                                                                                                                                |
| <b>RFU GUI Equivalent:</b> | From the “Choose File Locations...” dialog box, visible by selecting the menu option Setup   File Locations, type in a pathname or click on the ellipses radio button to browse for a file. |
| <b>Example:</b>            | <code>clRFU myProgram.bin -pb mySecondaryLoader.c</code>                                                                                                                                    |

## **-fi Flash.ini PathName**

|                            |                                                                                                                                                                                             |
|----------------------------|---------------------------------------------------------------------------------------------------------------------------------------------------------------------------------------------|
| <b>Description:</b>        | Select a new file that Dynamic C will use to externally define flash.                                                                                                                       |
| <b>Default:</b>            | <code>flash.ini</code>                                                                                                                                                                      |
| <b>RFU GUI Equivalent:</b> | From the “Choose File Locations...” dialog box, visible by selecting the menu option Setup   File Locations, type in a pathname or click on the ellipses radio button to browse for a file. |
| <b>Example:</b>            | <code>clRFU myProgram.bin -fi myflash.ini</code>                                                                                                                                            |

## **-vp+**

|                            |                                                                                                                                           |
|----------------------------|-------------------------------------------------------------------------------------------------------------------------------------------|
| <b>Description:</b>        | Verify the presence of the processor by using the DSR line of the PC serial connection.                                                   |
| <b>Default:</b>            | The processor is verified.                                                                                                                |
| <b>RFU GUI Equivalent:</b> | From the “Communications Options” dialog box, visible by selecting Setup   Communications, check the “Enable Processor Detection” option. |
| <b>Example:</b>            | <code>clRFU myProgram.bin -vp+</code>                                                                                                     |

## **-vp-**

|                            |                                                                                                                                             |
|----------------------------|---------------------------------------------------------------------------------------------------------------------------------------------|
| <b>Description:</b>        | Do not verify the presence of the processor.                                                                                                |
| <b>Default:</b>            | The processor is verified.                                                                                                                  |
| <b>RFU GUI Equivalent:</b> | From the “Communications Options” dialog box, visible by selecting Setup   Communications, uncheck the “Enable Processor Detection” option. |
| <b>Example:</b>            | <code>clRFU myProgram.bin -vp-</code>                                                                                                       |

## **-usb+**

|                            |                                                                                                                                            |
|----------------------------|--------------------------------------------------------------------------------------------------------------------------------------------|
| <b>Description:</b>        | Enable use of USB to serial converter.                                                                                                     |
| <b>Default:</b>            | The use of the USB to serial converter is disabled.                                                                                        |
| <b>RFU GUI Equivalent:</b> | From the “Communications Options” dialog box, visible by selecting Setup   Communications, check the “Use USB to Serial Converter” option. |
| <b>Example:</b>            | <code>clRFU myProgram.bin -usb+</code>                                                                                                     |

## **-usb-**

|                            |                                                                                                                                               |
|----------------------------|-----------------------------------------------------------------------------------------------------------------------------------------------|
| <b>Description:</b>        | Disable use of USB to serial converter.                                                                                                       |
| <b>Default:</b>            | The use of the USB to serial converter is disabled.                                                                                           |
| <b>RFU GUI Equivalent:</b> | From the “Communications Options” dialog box, visible by selecting Setup   Communications, uncheck the “Use USB to Servile Converter” option. |
| <b>Example:</b>            | <code>clRFU myProgram.bin -usb-</code>                                                                                                        |

# RABBIT<sup>®</sup> SOFTWARE END USER LICENSE AGREEMENT

IMPORTANT-READ CAREFULLY: BY INSTALLING, COPYING OR OTHERWISE USING THE ENCLOSED RABBIT DYNAMIC C SOFTWARE, WHICH INCLUDES COMPUTER SOFTWARE ("SOFTWARE") AND MAY INCLUDE ASSOCIATED MEDIA, PRINTED MATERIALS, AND "ONLINE" OR ELECTRONIC DOCUMENTATION ("DOCUMENTATION"), YOU (ON BEHALF OF YOURSELF OR AS AN AUTHORIZED REPRESENTATIVE ON BEHALF OF AN ENTITY) AGREE TO ALL THE TERMS OF THIS END USER LICENSE AGREEMENT ("LICENSE") REGARDING YOUR USE OF THE SOFTWARE. IF YOU DO NOT AGREE WITH ALL OF THE TERMS OF THIS LICENSE, DO NOT INSTALL, COPY OR OTHERWISE USE THE SOFTWARE AND IMMEDIATELY CONTACT RABBIT FOR RETURN OF THE SOFTWARE AND A REFUND OF THE PURCHASE PRICE FOR THE SOFTWARE.

We are sorry about the formality of the language below, which our lawyers tell us we need to include to protect our legal rights. If You have any questions, write or call Rabbit at (530) 757-4616, 2900 Spafford Street, Davis, California 95616.

1. **Definitions.** In addition to the definitions stated in the first paragraph of this document, capitalized words used in this License shall have the following meanings:
  - 1.1 "Qualified Applications" means an application program developed using the Software and that links with the development libraries of the Software.
    - 1.1.1 "Qualified Applications" is amended to include application programs developed using the Softools WinIDE program for Rabbit processors available from Softools, Inc.
    - 1.1.2 The MicroC/OS-II ( $\mu$ C/OS-II) library and sample code and the Point-to-Point Protocol (PPP) library are not included in this amendment.
    - 1.1.3 Excluding the exceptions in 1.1.2, library and sample code provided with the Software may be modified for use with the Softools WinIDE program in Qualified Systems as defined in 1.2. All other Restrictions specified by this license agreement remain in force.
  - 1.2 "Qualified Systems" means a microprocessor-based computer system which is either (i) manufactured by, for or under license from Rabbit, or (ii) based on the Rabbit 2000 microprocessor, the Rabbit 3000 microprocessor, the Rabbit 4000 microprocessor, or any other Rabbit microprocessor. Qualified Systems may not be (a) designed or intended to be re-programmable by your customer using the Software, or (b) competitive with Rabbit products, except as otherwise stated in a written agreement between Rabbit and the system manufacturer. Such written agreement may require an end user to pay run time royalties to Rabbit.
2. **License.** Rabbit grants to You a nonexclusive, nontransferable license to (i) use and reproduce the Software, solely for internal purposes and only for the number of users for which You have purchased licenses for (the "Users") and not for redistribution or resale; (ii) use and reproduce the Software solely to develop the Qualified Applications; and (iii) use, reproduce and distribute, the

Qualified Applications, in object code only, to end users solely for use on Qualified Systems; provided, however, any agreement entered into between You and such end users with respect to a Qualified Application is no less protective of Rabbit's intellectual property rights than the terms and conditions of this License. (iv) use and distribute with Qualified Applications and Qualified Systems the program files distributed with Dynamic C named RFU.EXE, PILOT.BIN, and COLD-LOAD.BIN in their unaltered forms.

3. **Restrictions.** Except as otherwise stated, You may not, nor permit anyone else to, decompile, reverse engineer, disassemble or otherwise attempt to reconstruct or discover the source code of the Software, alter, merge, modify, translate, adapt in any way, prepare any derivative work based upon the Software, rent, lease network, loan, distribute or otherwise transfer the Software or any copy thereof. You shall not make copies of the copyrighted Software and/or documentation without the prior written permission of Rabbit; provided that, You may make one (1) hard copy of such documentation for each User and a reasonable number of back-up copies for Your own archival purposes. You may not use copies of the Software as part of a benchmark or comparison test against other similar products in order to produce results strictly for purposes of comparison. The Software contains copyrighted material, trade secrets and other proprietary material of Rabbit and/or its licensors and You must reproduce, on each copy of the Software, all copyright notices and any other proprietary legends that appear on or in the original copy of the Software. Except for the limited license granted above, Rabbit retains all right, title and interest in and to all intellectual property rights embodied in the Software, including but not limited to, patents, copyrights and trade secrets.
4. **Export Law Assurances.** You agree and certify that neither the Software nor any other technical data received from Rabbit, nor the direct product thereof, will be exported outside the United States or re-exported except as authorized and as permitted by the laws and regulations of the United States and/or the laws and regulations of the jurisdiction, (if other than the United States) in which You rightfully obtained the Software. The Software may not be exported to any of the following countries: Cuba, Iran, Iraq, Libya, North Korea, Sudan, or Syria.
5. **Government End Users.** If You are acquiring the Software on behalf of any unit or agency of the United States Government, the following provisions apply. The Government agrees: (i) if the Software is supplied to the Department of Defense ("DOD"), the Software is classified as "Commercial Computer Software" and the Government is acquiring only "restricted rights" in the Software and its documentation as that term is defined in Clause 252.227-7013(c)(1) of the DFARS; and (ii) if the Software is supplied to any unit or agency of the United States Government other than DOD, the Government's rights in the Software and its documentation will be as defined in Clause 52.227-19(c)(2) of the FAR or, in the case of NASA, in Clause 18-52.227-86(d) of the NASA Supplement to the FAR.
6. **Disclaimer of Warranty.** You expressly acknowledge and agree that the use of the Software and its documentation is at Your sole risk. THE SOFTWARE, DOCUMENTATION, AND TECHNICAL SUPPORT ARE PROVIDED ON AN "AS IS" BASIS AND WITHOUT WARRANTY OF ANY KIND. Information regarding any third party services included in this package is provided as a convenience only, without any warranty by Rabbit, and will be governed solely by the terms agreed upon between You and the third party providing such services. RABBIT AND ITS LICENSORS EXPRESSLY DISCLAIM ALL WARRANTIES, EXPRESS, IMPLIED, STATUTORY OR OTHERWISE, INCLUDING BUT NOT LIMITED TO THE IMPLIED WARRANTIES OF MERCHANTABILITY, FITNESS FOR A PARTICULAR PURPOSE AND NON-INFRINGEMENT OF THIRD PARTY RIGHTS. RABBIT DOES NOT WARRANT THAT THE FUNCTIONS CONTAINED IN THE SOFTWARE WILL MEET YOUR REQUIREMENTS, OR THAT THE OPERATION OF THE SOFTWARE WILL BE UNINTERRUPTED OR ERROR-FREE, OR THAT DEFECTS IN THE SOFTWARE WILL BE CORRECTED. FURTHERMORE, RABBIT DOES NOT WARRANT OR MAKE ANY REPRESENTATIONS REGARDING THE USE OR THE

RESULTS OF THE SOFTWARE IN TERMS OF ITS CORRECTNESS, ACCURACY, RELIABILITY OR OTHERWISE. NO ORAL OR WRITTEN INFORMATION OR ADVICE GIVEN BY RABBIT OR ITS AUTHORIZED REPRESENTATIVES SHALL CREATE A WARRANTY OR IN ANY WAY INCREASE THE SCOPE OF THIS WARRANTY. SOME JURISDICTIONS DO NOT ALLOW THE EXCLUSION OF IMPLIED WARRANTIES, SO THE ABOVE EXCLUSION MAY NOT APPLY TO YOU.

7. **Limitation of Liability.** YOU AGREE THAT UNDER NO CIRCUMSTANCES, INCLUDING NEGLIGENCE, SHALL RABBIT BE LIABLE FOR ANY INCIDENTAL, SPECIAL OR CONSEQUENTIAL DAMAGES (INCLUDING DAMAGES FOR LOSS OF BUSINESS PROFITS, BUSINESS INTERRUPTION, LOSS OF BUSINESS INFORMATION AND THE LIKE) ARISING OUT OF THE USE AND/OR INABILITY TO USE THE SOFTWARE, EVEN IF RABBIT OR ITS AUTHORIZED REPRESENTATIVE HAS BEEN ADVISED OF THE POSSIBILITY OF SUCH DAMAGES. SOME JURISDICTIONS DO NOT ALLOW THE LIMITATION OR EXCLUSION OF LIABILITY FOR INCIDENTAL OR CONSEQUENTIAL DAMAGES SO THE ABOVE LIMITATION OR EXCLUSION MAY NOT APPLY TO YOU. IN NO EVENT SHALL RABBIT'S TOTAL LIABILITY TO YOU FOR ALL DAMAGES, LOSSES, AND CAUSES OF ACTION (WHETHER IN CONTRACT, TORT, INCLUDING NEGLIGENCE, OR OTHERWISE) EXCEED THE AMOUNT PAID BY YOU FOR THE SOFTWARE.
8. **Termination.** This License is effective for the duration of the copyright in the Software unless terminated. You may terminate this License at any time by destroying all copies of the Software and its documentation. This License will terminate immediately without notice from Rabbit if You fail to comply with any provision of this License. Upon termination, You must destroy all copies of the Software and its documentation. Except for Section 2 ("License"), all Sections of this Agreement shall survive any expiration or termination of this License.
9. **General Provisions.** No delay or failure to take action under this License will constitute a waiver unless expressly waived in writing, signed by a duly authorized representative of Rabbit, and no single waiver will constitute a continuing or subsequent waiver. This License may not be assigned, sub-licensed or otherwise transferred by You, by operation of law or otherwise, without Rabbit's prior written consent. This License shall be governed by and construed in accordance with the laws of the United States and the State of California, exclusive of the conflicts of laws principles. The United Nations Convention on Contracts for the International Sale of Goods shall not apply to this License. If for any reason a court of competent jurisdiction finds any provision of this License, or portion thereof, to be unenforceable, that provision of the License shall be enforced to the maximum extent permissible so as to affect the intent of the parties, and the remainder of this License shall continue in full force and effect. This License constitutes the entire agreement between the parties with respect to the use of the Software and its documentation, and supersedes all prior or contemporaneous understandings or agreements, written or oral, regarding such subject matter. There shall be no contract for purchase or sale of the Software except upon the terms and conditions specified herein. Any additional or different terms or conditions proposed by You or contained in any purchase order are hereby rejected and shall be of no force and effect unless expressly agreed to in writing by Rabbit. No amendment to or modification of this License will be binding unless in writing and signed by a duly authorized representative of Rabbit.

Digi International Inc. © 2008 • All rights reserved.

# INDEX

## Symbols

|                                  |                              |
|----------------------------------|------------------------------|
| <code>_GLOBAL_INIT</code> .....  | 214                          |
| “Defines Tab” on page 273 .....  | 135                          |
| <code>@LENGTH</code> .....       | 181                          |
| <code>@PC</code> .....           | 181                          |
| <code>@RETVAl</code> .....       | 181, 190                     |
| <code>@SP</code> .....           | 181, 184, 187, 189, 190, 195 |
| <code>*.*</code> .....           | 35                           |
| <code>\\</code> .....            | 159                          |
| <code>\n</code> .....            | 149                          |
| <code>\r</code> .....            | 149                          |
| <code>#asm</code> .....          | 175, 223, 326                |
| <code>#debug</code> .....        | 210, 224, 326                |
| <code>#define</code> .....       | 224                          |
| <code>#elif</code> .....         | 226                          |
| <code>#else</code> .....         | 226                          |
| <code>#endasm</code> .....       | 175, 180, 224                |
| <code>#endif</code> .....        | 226                          |
| <code>#error</code> .....        | 224                          |
| <code>#fatal</code> .....        | 225                          |
| <code>#funcchain</code> .....    | 31, 225                      |
| <code>#if</code> .....           | 226                          |
| <code>#ifdef</code> .....        | 226                          |
| <code>#ifndef</code> .....       | 227                          |
| <code>#include</code> .....      | 227                          |
| absence of .....                 | 33                           |
| <code>#interleave</code> .....   | 227                          |
| <code>#makechain</code> .....    | 31, 228                      |
| <code>#mmap</code> .....         | 228, 328                     |
| <code>#nodebug</code> .....      | 210, 224, 326                |
| <code>#nointerleave</code> ..... | 227                          |
| <code>#noseix</code> .....       | 229                          |
| <code>#use</code> .....          | 33, 36, 229                  |
| <code>#useix</code> .....        | 229                          |
| <code>#warns</code> .....        | 229                          |
| <code>#warnt</code> .....        | 229                          |
| <code>#ximport</code> .....      | 230                          |
| <code>#zimport</code> .....      | 230                          |

## A

|                       |     |
|-----------------------|-----|
| abandon .....         | 196 |
| abort .....           | 196 |
| about Dynamic C ..... | 305 |

|                              |                 |
|------------------------------|-----------------|
| adc (add-with-carry) .....   | 175             |
| add-on modules .....         | 336             |
| address .....                | 87              |
| address space .....          | 11, 137         |
| Advanced button .....        | 286             |
| align .....                  | 197             |
| ALT key                      |                 |
| See keystrokes               |                 |
| always_on .....              | 197             |
| anymem .....                 | 197             |
| application program .....    | 33              |
| argument passing .....       | 184, 190, 191   |
| arrange icons .....          | 296             |
| arrow keys .....             | 246, 247        |
| asm .....                    | 198             |
| assembly .....               | 9, 175–195, 256 |
| blocks in xmem .....         | 183             |
| embedding C statements ..... | 176             |
| stand-alone .....            | 182             |
| window .....                 | 186, 299        |
| assignment operators .....   | 235             |
| associativity .....          | 231, 232        |
| auto .....                   | 181, 182, 198   |
| storage of variables .....   | 184             |

## B

|                                  |               |
|----------------------------------|---------------|
| backslash (\)                    |               |
| continuation in directives ..... | 223           |
| baud rate .....                  | 111, 280      |
| BCDE .....                       | 182, 190, 191 |
| BeginHeader .....                | 36, 37, 38    |
| binary operators .....           | 231           |
| BIOS                             |               |
| _xexit .....                     | 131           |
| calling premain() .....          | 100           |
| command line compiler .....      | 307, 314      |
| compilation environments .....   | 322           |
| compile option .....             | 332           |
| configuration macros .....       | 135           |
| macro definitions .....          | 290           |
| memory location .....            | 138           |
| memory settings .....            | 287           |
| user-defined .....               | 286, 325      |
| variable defined in .....        | 203           |

blocking ..... 143  
board information ..... 254, 291–??  
BPB ..... 170  
break ..... 199, 217  
breakpoints  
  assembly window ..... 186  
  enable ..... 288  
  hard ..... 257  
  hardware ..... 82, 257  
  interrupt status ..... 256, 257  
  library code ..... 256  
  library files ..... 202  
  norst keyword ..... 211  
  persistent ..... 256  
  RST 28 ..... 326  
  single stepping ..... 256  
  soft ..... 256  
  Watches window ..... 260

## C

C language ..... 9, 10, 31, 178, 182  
  calling assembly ..... 189  
  embedded in assembly ..... 176  
cached write ..... 150  
call sequence ..... 301  
cascaded windows ..... 296  
case ..... 199, 202  
Casting ..... 26  
casting ..... 25  
char ..... 200, 220  
clipboard ..... 251  
closing a file ..... 249  
CoData Structure ..... 47  
  pointer to ..... 49  
cofunc ..... 200  
cofunctions ..... 50–56  
  abandon ..... 55  
  calling restrictions ..... 51  
  everytime ..... 55  
  firsttime ..... 207  
  indexed ..... 53  
  keyword ..... 200  
  single user ..... 53  
  suspend ..... 219  
  syntax ..... 51  
cold loader ..... 255  
column resizing ..... 300  
command line interface ..... 306–321  
compile  
  BIOS ..... 255  
  command line ..... 306–319  
  errors ..... 253  
  menu ..... 254  
  options ..... 282

RAM ..... 330  
speed ..... 9  
status ..... 301  
to .bin file ..... 255  
to file ..... 246  
to flash ..... 254  
to target ..... 246, 254  
compiler directives ..... 223  
  #asm ..... 175, 223, 326  
  options ..... 223  
  #class ..... 223  
  options ..... 223  
  #debug ..... 210, 224, 326  
  #define ..... 224  
  #elif ..... 226  
  #else ..... 226  
  #endasm ..... 175, 180, 224  
  #endif ..... 226  
  #error ..... 224  
  #fatal ..... 225  
  #funcchain ..... 31, 225  
  #GLOBAL\_INIT ..... 225  
  #if ..... 226  
  #ifdef ..... 226  
  #ifndef ..... 227  
  #include ..... 227  
  #interleave ..... 227  
  #makechain ..... 31, 228  
  #mmap ..... 228  
  options ..... 228  
  #nodebug ..... 210, 224, 326  
  #nointerleave ..... 227  
  #nouseix ..... 229  
  #pragma ..... 228  
  #undef ..... 228  
  #use ..... 33, 36, 229  
  #useix ..... 229  
  #warns ..... 229  
  #warn ..... 229  
  #ximport ..... 230  
  #zimport ..... 230  
  line continuation ..... 223  
compression ..... 338  
const ..... 178, 201, 223  
Const and pointers ..... 23  
const conversions ..... 25  
continue ..... 201, 217  
copying text ..... 251  
costate ..... 201  
costatements ..... 43–50  
  abort ..... 196  
  firsttime ..... 207  
  keyword ..... 201  
  suspend ..... 219

|                                  |                  |
|----------------------------------|------------------|
| syntax .....                     | 44               |
| yield .....                      | 222              |
| cursor                           |                  |
| execution .....                  | 256, 257, 258    |
| positioning .....                | 247, 253         |
| cutting text .....               | 251              |
| <b>D</b>                         |                  |
| data structure                   |                  |
| offset of element .....          | 181              |
| returned by function .....       | 190              |
| DATAORG .....                    | 328, 330         |
| DATASEG .....                    | 137              |
| date and time .....              | 101              |
| db .....                         | 178              |
| debug .....                      | 326              |
| dialog box .....                 | 288              |
| differences highlighting .....   | 261              |
| disassemble at address .....     | 260              |
| disassembled code .....          | 260              |
| hints and tips .....             | 77–99            |
| keyword .....                    | 202              |
| memory dump .....                | 261              |
| polling the target .....         | 256              |
| step over .....                  | 256              |
| switching modes .....            | 253              |
| trace into .....                 | 256              |
| update watch expressions .....   | 260              |
| watchdog timers .....            | 103              |
| windows .....                    | 272–278, 298–301 |
| declarations .....               | 36               |
| default .....                    | 202              |
| Default Compile Mode .....       | 285              |
| delay loop .....                 | 102              |
| delimiter matching .....         | 247              |
| demotion .....                   | 283, 284         |
| differences highlighting .....   | 261              |
| disassemble                      |                  |
| at address .....                 | 260, 299         |
| at cursor .....                  | 260, 299         |
| DLM and FAT .....                | 158              |
| DMA .....                        | 140–142          |
| download manager .....           | 158              |
| downloading .....                | 9                |
| DSR check .....                  | 281              |
| dump window .....                | 262              |
| dw .....                         | 179              |
| Dynamic C                        |                  |
| differences .....                | 10, 31           |
| exit .....                       | 250              |
| support files .....              | 40               |
| Dynamic C modules .....          | 336              |
| dynamic memory allocation .....  | 140              |
| dynamic storage allocation ..... | 19               |

## E

|                         |              |
|-------------------------|--------------|
| Edit menu .....         | 251          |
| edit mode .....         | 253          |
| editor .....            | 9            |
| else .....              | 203          |
| embedded assembly ..... | 9, 183, 190  |
| End key .....           | 246          |
| EndHeader .....         | 36, 37, 38   |
| enum .....              | 203          |
| EPROM .....             | 11           |
| equ .....               | 180          |
| errors                  |              |
| error code ranges ..... | 131          |
| locating .....          | 253          |
| run-time .....          | 282          |
| ESC key                 |              |
| to close menu .....     | 247          |
| examples                |              |
| delay loop .....        | 102          |
| modules .....           | 38           |
| timing loop .....       | 101          |
| exit Dynamic C .....    | 250          |
| extended memory .....   | 11, 189, 221 |
| asm blocks .....        | 183          |
| extern .....            | 38, 203      |

## F

|                                        |            |
|----------------------------------------|------------|
| far pointers and data .....            | 20–23, 204 |
| FAT                                    |            |
| attributes of a file .....             | 152        |
| blocking a non-blocking function ..... | 154        |
| BPB .....                              | 170        |
| carriage return .....                  | 149        |
| clusters and sectors .....             | 168        |
| configuration library .....            | 146        |
| costatements .....                     | 154–156    |
| creating a file .....                  | 149        |
| custom device driver .....             | 146        |
| device .....                           | 143        |
| directory .....                        | 143        |
| download manager (DLM) .....           | 158        |
| error codes .....                      | 144        |
| escape character .....                 | 159        |
| fat_AutoMount .....                    | 147        |
| fat_config.lib .....                   | 146        |
| fat_Init .....                         | 147        |
| fat_part_mounted .....                 | 147        |
| flash types supported .....            | 144        |
| hot-swapping .....                     | 172, 173   |
| initialization .....                   | 147        |
| line feed .....                        | 149        |
| max number of characters read .....    | 150        |
| MBR .....                              | 168        |

|                               |                    |
|-------------------------------|--------------------|
| non-blocking .....            | 153                |
| num_fat_devices .....         | 147                |
| opening a file .....          | 149                |
| partition .....               | 143                |
| partition structure .....     | 147                |
| partitioning .....            | 157–159            |
| path separator .....          | 159                |
| prealloc .....                | 146                |
| reading a file .....          | 150                |
| removable device advice ..... | 150                |
| reserving file space .....    | 146                |
| SD card .....                 | 173                |
| SF1000 .....                  | 172                |
| shell program .....           | 151                |
| state of file .....           | 154                |
| subdirectory .....            | 143                |
| unsupported features .....    | 173                |
| write-back cache .....        | 150                |
| writing a file .....          | 149                |
| xD card .....                 | 172                |
| μC/OS-II compatibility .....  | 172                |
| fat_part_mounted .....        | 162                |
| FAT_USE_FORWARDSLASH .....    | 159                |
| file                          |                    |
| attributes .....              | 152                |
| commands .....                | 249                |
| compression .....             | 338                |
| create .....                  | 149                |
| extensions .....              | 255                |
| generated .....               | 255                |
| open .....                    | 149, 159           |
| print .....                   | 250                |
| read .....                    | 150, 160           |
| seek .....                    | 161                |
| state .....                   | 154                |
| write .....                   | 149, 160           |
| files                         |                    |
| additional source .....       | 33                 |
| Find Next <F3> .....          | 252                |
| firsttime .....               | 207                |
| flags register .....          | 301                |
| flash                         |                    |
| xmem access .....             | 137                |
| float .....                   | 207, 220           |
| for loop .....                | 208                |
| frame                         |                    |
| reference point .....         | 190                |
| reference pointer .....       | 187, 189, 211, 326 |
| function                      |                    |
| auto variables .....          | 198                |
| calls .....                   | 184, 190           |
| calls from assembly .....     | 191                |
| chains .....                  | 31, 214            |
| create chains .....           | 228                |

|                                |          |
|--------------------------------|----------|
| entry and exit .....           | 326      |
| headers .....                  | 40       |
| help .....                     | 40       |
| indirect call .....            | 29       |
| prototypes .....               | 36       |
| returns .....                  | 190, 191 |
| saving registers .....         | 195      |
| stack space .....              | 326      |
| unbalanced stack .....         | 195      |
| function lookup <CTRL-H> ..... | 303      |
| function prefix                |          |
| anymem .....                   | 197      |
| debug .....                    | 202      |
| firsttime .....                | 207      |
| interrupt .....                | 209      |
| nodebug .....                  | 210      |
| norst .....                    | 211      |
| nouseix .....                  | 211      |
| root .....                     | 213      |
| size .....                     | 215      |
| speed .....                    | 215      |
| useix .....                    | 218      |
| xmem .....                     | 221      |
| Functions .....                | 107      |

## G

|                             |          |
|-----------------------------|----------|
| Global Initialization ..... | 32       |
| global variables .....      | 19       |
| goto .....                  | 208, 253 |
| grep .....                  | 253      |

## H

|                         |                    |
|-------------------------|--------------------|
| hard breakpoints .....  | 257                |
| header                  |                    |
| function .....          | 40                 |
| module .....            | 36, 37, 38         |
| Help menu .....         | 303                |
| HL .....                | 182, 187, 190, 191 |
| Home key .....          | 246                |
| horizontal tiling ..... | 296                |
| hot-swapping .....      | 172, 173           |

## I

|                                 |          |
|---------------------------------|----------|
| icons                           |          |
| arranged .....                  | 296      |
| IEEE floating point .....       | 207      |
| if .....                        | 203      |
| information window .....        | 296, 301 |
| init_on .....                   | 209      |
| inline code .....               | 285      |
| insertion point .....           | 251, 253 |
| Inspect menu .....              | 259, 298 |
| Instruction Set Reference ..... | 305      |

|                       |                        |
|-----------------------|------------------------|
| int                   | 209, 220               |
| interrupts            | 191                    |
| breakpoints           | 256                    |
| keyword for ISR       | 209                    |
| latency               | 191                    |
| unpreserved registers | 195                    |
| vectors               | 192                    |
| ISR                   | 191, 328               |
| IX (index register)   | 52, 187, 189, 211, 218 |

## K

|                        |     |
|------------------------|-----|
| key                    | 36  |
| keystrokes             |     |
| <ALT-Backspace>        |     |
| undoing changes        | 251 |
| <ALT-C>                |     |
| select Compile menu    | 254 |
| <ALT-F10>              |     |
| Disassemble at Address | 260 |
| <ALT-F2>               |     |
| Toggle Hard Breakpoint | 257 |
| <ALT-F4>               |     |
| quitting Dynamic C     | 250 |
| <ALT-F9>               |     |
| Run w/ No Polling      | 256 |
| <ALT-H>                |     |
| select Help menu       | 303 |
| <ALT-O>                |     |
| select Options menu    | 263 |
| <ALT-SHIFT-backspace>  |     |
| redoing changes        | 251 |
| <ALT-W>                |     |
| select Window menu     | 296 |
| <CTRL-F10>             |     |
| Disassemble at Cursor  | 260 |
| <CTRL-F2>              |     |
| Reset Program          | 258 |
| <CTRL-G>               |     |
| Goto                   | 253 |
| <CTRL-H>               |     |
| Library Help lookup    | 303 |
| <CTRL-N>               |     |
| next error             | 253 |
| <CTRL-O>               |     |
| Poll Target            | 258 |
| <CTRL-P>               |     |
| previous error         | 253 |
| <CTRL-U>               |     |
| Update Watch window    | 260 |
| <CTRL-V>               |     |
| pasting text           | 251 |
| <CTRL-W>               |     |
| Add/Del Items          | 260 |
| <CTRL-X>               |     |

|                           |               |
|---------------------------|---------------|
| cutting text              | 251           |
| <CTRL-Y>                  |               |
| Reset Target/Compile BIOS | 255           |
| <CTRL-Z>                  |               |
| Stop                      | 256           |
| <F10>                     |               |
| Assembly window           | 296           |
| <F2>                      |               |
| Toggle Breakpoint         | 256           |
| <F3>                      |               |
| Find Next                 | 252           |
| <F5>                      |               |
| Compile                   | 254           |
| <F7>                      |               |
| Trace into                | 256           |
| <F8>                      |               |
| Step over                 | 256           |
| <F9>                      |               |
| Run                       | 256           |
| keywords                  | 189, 196, 211 |
| abort                     | 196           |
| align                     | 197           |
| always_on                 | 197           |
| anymem                    | 197           |
| asm                       | 198           |
| auto                      | 198           |
| bbram                     | 198           |
| break                     | 199           |
| c                         | 199           |
| case                      | 199           |
| char                      | 200           |
| cofunc                    | 200           |
| const                     | 178           |
| continue                  | 201           |
| costate                   | 201           |
| debug                     | 202           |
| default                   | 202           |
| do                        | 202           |
| else                      | 203           |
| enum                      | 203           |
| extern                    | 203           |
| far                       | 204           |
| firsttime                 | 207           |
| float                     | 207           |
| for                       | 208           |
| goto                      | 208           |
| if                        | 208           |
| init_on                   | 209           |
| int                       | 209           |
| interrupt                 | 209           |
| long                      | 210           |
| nodebug                   | 210           |
| norst                     | 211           |
| nouseix                   | 211           |

|             |     |
|-------------|-----|
| NULL        | 211 |
| protected   | 212 |
| register    | 212 |
| return      | 213 |
| root        | 213 |
| scofunc     | 213 |
| segchain    | 214 |
| shared      | 214 |
| short       | 214 |
| size        | 215 |
| sizeof      | 215 |
| speed       | 215 |
| static      | 216 |
| struct      | 216 |
| switch      | 217 |
| typedef     | 217 |
| union       | 218 |
| unsigned    | 218 |
| useix       | 218 |
| void        | 221 |
| volatile    | 222 |
| waitfor     | 219 |
| waitfordone | 219 |
| while       | 220 |
| xdata       | 220 |
| xmem        | 221 |
| xstring     | 222 |
| yield       | 222 |

## L

|                       |            |
|-----------------------|------------|
| language elements     | 196        |
| operators             | 231        |
| lib.dir               | 33, 35, 39 |
| libraries             | 9, 33      |
| linking               | 33         |
| real-time programming | 9          |
| writing your own      | 36         |
| Library Help lookup   | 40, 303    |
| linking               | 9          |
| list files            | 284        |
| locating errors       | 253        |
| long                  |            |
| keyword               | 210        |
| lookup function       | 303        |
| loops                 |            |
| delay with MS_TIMER   | 102        |
| do                    | 202        |
| for                   | 208        |
| timing with MS_TIMER  | 101        |

## M

|               |              |
|---------------|--------------|
| macros        | 180, 224     |
| main function | 33, 210, 326 |
| MAP File      | 87           |

|                        |                    |
|------------------------|--------------------|
| MBR                    | 168                |
| memory                 |                    |
| address space          | 137                |
| DATAORG                | 328, 330           |
| dump                   | 259                |
| dump at address        | 261                |
| dump flash             | 261                |
| dump to file           | 261                |
| dynamic allocation     | 140                |
| extended               | 11, 189, 221       |
| management             | 197, 213           |
| map                    | 335                |
| root                   | 139, 181, 213, 328 |
| root keyword           | 11                 |
| memory management unit | 11, 137            |
| menus                  |                    |
| close all open         | 247                |
| Compile                | 254                |
| Edit                   | 251                |
| Help                   | 303                |
| Inspect                | 259, 298           |
| Options                | 263                |
| Run                    | 256                |
| message window         | 253, 296           |
| MMU                    | 11, 137            |
| mode                   |                    |
| debug (run)            | 253                |
| edit                   | 253                |
| print preview          | 250                |
| modules                | 36, 38, 39, 336    |
| body                   | 36, 38, 39         |
| example                | 38                 |
| header                 | 36, 37, 38, 203    |
| key                    | 36, 37             |
| mouse                  | 246                |
| MS_TIMER               | 101, 333           |
| multitasking           |                    |
| cooperative            | 41                 |
| preemptive             | 58                 |

## N

|                     |                              |
|---------------------|------------------------------|
| names               |                              |
| in assembly         | 181                          |
| Next error <CTRL-N> | 253                          |
| nodebug             | 175, 210, 256, 260, 283, 326 |
| non-blocking        | 143                          |
| norst               | 211                          |
| nouseix             | 211                          |
| NULL                | 211                          |

## O

|                     |          |
|---------------------|----------|
| offsets in assembly | 187, 189 |
| online help         | 40, 305  |
| operators           | 231      |

|                             |          |
|-----------------------------|----------|
| arithmetic operators .....  | 232      |
| decrement (--)              | 234      |
| division (/)                | 233      |
| increment (++)              | 234      |
| indirection (*)             | 233      |
| minus (-)                   | 232      |
| modulus (%)                 | 234      |
| multiplication (*)          | 233      |
| plus (+)                    | 232      |
| pointers                    | 233      |
| post-decrement (--)         | 234      |
| post-increment (++)         | 234      |
| pre-decrement (--)          | 234      |
| pre-increment (++)          | 234      |
| assignment operators .....  | 235      |
| add assign (+=)             | 235      |
| AND assign (&=)             | 236      |
| assign (=)                  | 235      |
| divide assign (/=)          | 235      |
| modulo assign (%=)          | 235      |
| multiply assign (*=)        | 235      |
| OR assign ( =)              | 236      |
| shift left (<<=)            | 235      |
| shift right (>>=)           | 235      |
| subtract assign (-=)        | 235      |
| XOR assign (^=)             | 236      |
| associativity .....         | 231, 232 |
| binary .....                | 231      |
| bitwise operators           |          |
| address (&)                 | 237      |
| bitwise AND (&)             | 237      |
| bitwise exclusive OR (^)    | 237      |
| bitwise inclusive OR ( )    | 237      |
| complement (~)              | 237      |
| pointers                    | 237      |
| shift left (<<)             | 236      |
| shift right (>>)            | 236      |
| comma .....                 | 245      |
| conditional operators (? :) | 243      |
| equality operators .....    | 239      |
| equal (==)                  | 239      |
| not equal (!=)              | 239      |
| in assembly .....           | 178      |
| logical operators .....     | 240      |
| logical AND (&&)            | 240      |
| logical NOT (!)             | 240      |
| logical OR (  )             | 240      |
| operator precedence .....   | 245      |
| postfix expressions .....   | 240      |
| ( ) parentheses             | 240      |
| [ ] array indices           | 240      |
| dot (.)                     | 241      |
| parentheses ( )             | 240      |
| right arrow (->)            | 241      |

|                                       |     |
|---------------------------------------|-----|
| precedence .....                      | 231 |
| reference/dereference operators ..... | 242 |
| address (&)                           | 242 |
| bitwise AND (&)                       | 242 |
| indirection (*)                       | 242 |
| multiplication (*)                    | 242 |
| relational operators .....            | 238 |
| greater than (>)                      | 238 |
| greater than or equal (>=)            | 238 |
| less than (<)                         | 238 |
| less than or equal (<=)               | 238 |
| sizeof .....                          | 244 |
| unary .....                           | 231 |
| optimize size or speed .....          | 283 |
| options                               |     |
| compiler .....                        | 282 |
| menu .....                            | 263 |
| origins .....                         | 223 |

## P

|                               |                  |
|-------------------------------|------------------|
| PageDown key .....            | 246              |
| PageUp key .....              | 246              |
| Parameter Passing .....       | 26               |
| parameter passing .....       | 25               |
| passing arguments .....       | 184, 190, 191    |
| pasting text .....            | 251              |
| periodic interrupt .....      | 50, 59, 100, 333 |
| pointer checking .....        | 19               |
| poll target .....             | 258              |
| polling .....                 | 256              |
| positioning text .....        | 253              |
| precompile .....              | 37               |
| preserving registers .....    | 191, 195         |
| Previous error <CTRL-P> ..... | 253              |
| primary register .....        | 182, 190, 191    |
| print                         |                  |
| choosing a printer .....      | 250              |
| print file .....              | 250              |
| print preview .....           | 250              |
| printf .....                  | 273              |
| program                       |                  |
| reset .....                   | 258              |
| Project Explorer .....        | 296              |
| project files .....           | 249, ??-324      |
| promotion .....               | 232              |
| protected                     |                  |
| keyword .....                 | 212              |
| variables .....               | 9, 212           |
| prototypes                    |                  |
| checking .....                | 283              |
| function .....                | 36               |
| in module header .....        | 36               |

## Q

quitting Dynamic C .....250

## R

Rabbit 4000 configuration .....336

Rabbit restart

protected variables .....212

RAM compile .....330

RAM functions .....195

reading max number of characters .....150

real-time

programming .....9

redoing changes .....251

registers

saving and restoring .....191

shadow .....334

snapshots .....301

window .....296, 301

relocatable code .....195

reset

program .....258

resizing columns .....300

ret .....190, 192

reti .....192

return .....190, 213, 217

return address .....184

RFU .....340

command line .....341

root memory

keyword .....213

memory map .....137

static variables .....139

variable address .....181

ROOT\_SIZE\_4K .....332

RST 28H .....256, 326

run

menu .....256

mode .....253, 256

no polling .....256

## S

saving a file .....249

scofunc .....213

search text .....252

SEC\_TIMER .....101, 333

segchain .....31, 214

segmented .....87

segmented address .....87

SEGSIZE .....137

separate I&D space .....178, 192, 261, 284

shadow registers .....334

shared .....214

shared variables .....9, 212

short .....214

Simple Constants .....23

single stepping

assembly window .....186

library files .....202

options .....256

watches window .....260

size .....215, 283

sizeof .....215

slave port .....104

slice statements .....58

soft breakpoints .....256

source files .....33

SP (stack pointer) .....184, 190, 191, 195, 229

special symbols

in assembly .....181

speed .....215, 283

stack

enable tracing .....289

enter function .....326

frame .....184, 190, 191, 195

frame reference point .....190

frame reference pointer .....187, 189, 211, 326

function returning struct .....190

ISR .....192

local variables .....187, 198

nouseix .....211

pointer (SP) .....184, 190, 191, 195, 229

snapshots .....301

trace window .....278, 301

unbalanced .....195

window .....301

STACKSEG .....137

state machine

example .....42

static variables

keyword .....216

root memory .....139

status register .....301

Stdio window .....272, 296

STDIO\_DEBUG\_SERIAL .....273

step over .....256

stop program execution .....256

storage class

auto .....19

static .....19

strings .....220

struct keyword .....216

structure

offset of element .....181

return space .....184, 190, 191

returned by function .....190

support files .....40

switch .....202, 217

- case .....217
- switching to edit mode .....253
- symbol information .....335
- symbolic constant .....224

## T

- target information ..... 254, 291-??
- text editing .....251
- text search .....252
- The const Keyword .....23
- TICK\_TIMER ..... 101, 333
- tiling windows .....296
- timing loop ..... 101
- toggle
  - breakpoint .....256, 257
- toolbar .....294
- trace into .....256
- type
  - casting .....232
  - checking .....283
- typedef .....217

## U

- unary operators .....231
- unbalanced stack .....195
- undoing changes .....251
- union .....218
- unpreserved registers ..... 191, 195
- unsigned .....218
- untitled files .....249
- USB .....281
- useix ..... 187, 218, 326
- User block .....327
- Utility Programs
  - File Compression/Decompression .....338
  - Font/ Bitmap Converter .....340
  - Rabbit Field Utility .....340

## V

- variables
  - auto .....198
  - global .....19
  - static .....216
- vertical tiling .....296
- virtual watchdogs .....103
- void .....221
- volatile .....222

## W

- waitfor .....219
- waitfordone .....219
- warning reports .....284
- watch expressions

- add or delete .....259
- enable .....289
- watch menu option .....298
- watch window .....260
- window .....296
- watchdog timers .....103
- watchdogs, virtual .....103
- wfd .....219
- while .....220
- wildcard mask .....35
- windows
  - assembly .....186, 299
  - cascaded .....296
  - information .....296, 301
  - message .....296
  - register .....296, 301
  - stack .....296, 301
  - Stdio .....272, 296
  - tiled horizontally .....296
  - tiled vertically .....296
  - watch .....260, 296, 298

## X

- xdata .....220
- xmem .....189, 221
  - asm blocks .....183
  - definition .....137
  - root functions in .....209
- XPC .....137, 328
- xstring .....222

## Y

- yield .....222

## Z

- μC/OS-II .....61
  - compatibility with TCP/IP .....75
  - restrictions .....64