

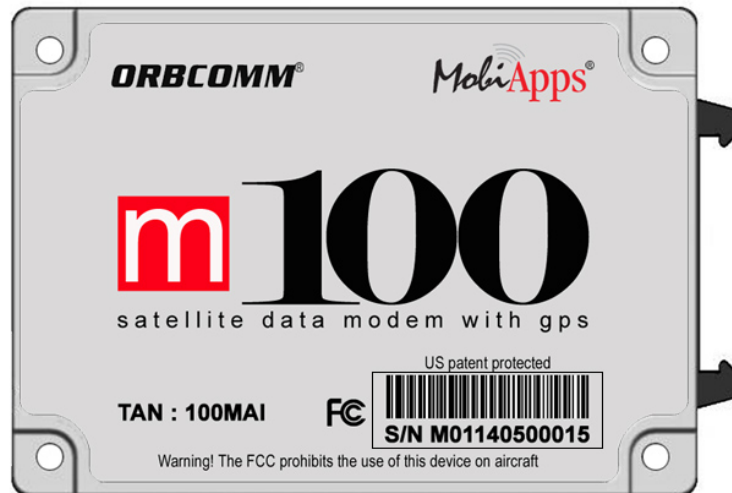

m100 USER MANUAL



Product Version: 1.1

May 2007

Copyright© 2007 m100

m100 User Manual, Product Version: 1.1

Copyright © 2007 MobiApps

All rights reserved.

MobiApps has prepared the information contained herein, solely for the use of employees, agents and its customers. The information contained in this document is subject to change. Any change that occurs shall be in accordance with MobiApps control procedure. This document contains proprietary information and is protected by copyright. Preparing derivative works or providing instruction based on the material is prohibited unless agreed to in writing by MobiApps.

All information contained herein is believed to be accurate and reliable. MobiApps may make improvement and/or changes in the product(s) and the program(s) described in this manual at any time and without notice.

Trademarks

All Names, products, and trademarks of other companies used in for publishing the manual are the property of their respective owners and are acknowledged. MS Word, Windows 2000, are the registered trademarks of Microsoft Corporation. Acrobat is the registered trademarks of Adobe Corporation.

Important Safety Notices

Carefully observe the safety alert symbols below for dangers, warnings, and cautions. They alert installers and operators of possible dangers and also give important and necessary information regarding the product.

Technical Support

For assistance or repair of the m100, please contact MobiApps at the following:

Website	www.mobiapps.com
Postal Address	7315 Wisconsin Ave Suite 1050E Bethesda, MD 20814

Table of Contents

Important Safety Notices.....	ii
Technical Support.....	ii
Table of Contents.....	iii
About this Manual.....	1
Purpose of the Manual.....	1
Manual Organization.....	1
Reference Document.....	1
Symbols used in the Manual.....	1
Who should read this Manual.....	2
Glossary.....	2
Introduction.....	3
Overview about ORBCOMM.....	3
Overview about m100.....	3
General Representation.....	4
Section – 1: m100.....	5
Chapter 1: Hardware Integration.....	6
Overview.....	6
m100 Block Diagram.....	6
I/O Pin Interface Specification.....	8
Interface Connector.....	8
Mounting Details.....	9
General Description of m100.....	10
Power Interface.....	11
Antenna Interface.....	11
Chapter: 2 Software Interface.....	12
System Environment.....	12
Diagnostic Port.....	13
Commands and Responses.....	13
Host -1 Serial Port.....	13
Host - 2 Serial Port.....	13
Firmware Upgrade Procedures.....	13
Developing Applications.....	14
Chapter 3: Operation.....	15
System Architecture.....	15
Device Configuration.....	15
Host Vs Diagnostic Port.....	16
Sending and Receiving Message.....	16
Low Power Modes.....	16
Satellite Acquisition.....	16
Section 2: DK100.....	17
Chapter 1: Introduction to DK100.....	18
Overview.....	18
Key Features.....	18
On-board Peripherals.....	19
General Precautions.....	19
DK100 PCB.....	19

Block Diagram	20
Chapter 2: DK100 Hardware Interface	21
DK100 Architecture	21
Power Supply	22
Analog Input	22
Digital Input / Output	22
GPIO	23
Potentiometer	23
m100 Interface	23
Serial Ports	24
Chapter 3: Setting Up DK100 Evaluation Kit	25
DK100 Evaluation Kit Architecture	25
Connecting the m100 SC to the Hardware Interface Unit ...	25
Connecting Host Port to Customer Target Circuitry	25
Connecting Diagnostic Port to DTE	25
Powering the DK100 Evaluation Kit	25
Troubleshooting	26
Appendix	27
Application Interface	27
Satellite Communications	27
Power Specifications	27
Application Programming	27
Environment	27
Mechanical	27
GPS	27
Antenna Specifications	28
Standard Pin Diagram	28

About this Manual

Purpose of the Manual

This manual describes all the features, functions and interfaces of m100. The manual also covers the hardware integration, software interface, operations, features of the evaluation kit, and the specifications required for m100. This manual also provides a list of accessories required with the evaluation kit.

Manual Organization

This manual has two sections. The first section covers the all the details of the m100 Satellite- Data Modem. The third section explains the DK100 Evaluation Kit. Each section has chapters which are divided into topics for easy reference.

Section 1: m100 - This section introduces you to m100 Hardware Integration, Software Interface and the Operations. These chapters provide you with the information of m100 which covers the block diagram, firmware details, and system architecture.

Section 2: DK100 Evaluation Kit - This section introduces you to the DK100 Evaluation Kit. It provides the key features, connection details, PCB layout, block diagram. This section helps the user to understand the interfacing between m100 with the application.



Reference Document

The m100 user manual references the following documents:

- ORBCOMM Serial Interface specification
- SDK API programmers guide
- m100 Hardware Interface guide
- ORBCOMM system overview

Symbols used in the Manual

The symbols shown below are used throughout this manual to highlight important instructions.

Symbol	Description
	<p>Warning! <i>If ignored, may cause permanent damage to the development kit or injury to a person.</i></p> <p>Caution! <i>Failure to comply with a caution may result in failure or damage to the device.</i></p> <p>Danger! <i>Failure to comply with a danger symbols results in serious injury.</i></p>
	<p><i>Tip. Information that may be beneficial to the user. Experienced or qualified personnel may choose to skip.</i></p>
	<p><i>Provides additional information corresponding to the topic that is being discussed.</i></p>

Who should read this Manual

Target audience for this manual are listed below:

- OEM customers
- Programmers and test engineers
- System integrators

Glossary

Analog	Describes data that can assume a continuous range of values such as current, voltage or pressure readings. The amplitude of such a signal fluctuates over a continuous range from zero to the maximum/peak output.
ASCII	American Standard Code for Information Interchange: A standard developed by ANSI that defines how computers write and read characters. It consists of 128 characters including letters, numbers, punctuation and control codes. Each character is represented by a number. It's used by most operating systems.
DB9	A nine pin physical connector that is common on PCs and a secondary connector specified in RS-232.
DC	Abbreviation for Direct Current. A movement of electric charge across an arbitrarily defined surface in one direction only.
Diagnostic Port	Diagnostic port is a port of the modem. The baud rate of this port is fixed (115200). The user can view the debug statements on the HyperTerminal connected to the Diagnostic port of the modem.
Digital	Describes data that can assume only two values: on or off, 1 or 0, true or false. Also known as discrete.
DK 100	DK 100 is a Printed Circuit Board on which m100 transceiver and other electronic devices are mounted.
DTE	Abbreviation for Data Terminal Equipment. Any digital device that transmits and receives data.
FRC	Flat Ribbon Cable – This is the cable that connects m100SC and DK 100 Evaluation Kit.
Globalgram	A Globalgram is a basic service element for the SC to send and receive a single, self contained data packet from a satellite when the satellite does not have access to ORBCOMM gateway.
GPS	Abbreviation for Global Positioning System. A worldwide MEO satellite navigational system formed by 24 satellites orbiting the earth and their corresponding receivers on the earth. The satellites orbit the earth at approximately 12,000 miles above the surface and make two complete orbits every 24 hours. The GPS satellites continuously transmit digital radio signals that contain data on the satellites location and the exact time to the earth-bound receivers.
Hex	Hexadecimal. Made up of 16 parts. The hexadecimal numbering system uses the numbers 0 to 9 plus letters A through F to represent the 16 digits.
I/O	Input/Output. The flow of data to and from the device. Also referred to the peripherals sending the data, and the path they use.
Modem	Modulator-Demodulator. A modem is a device or program that enables a computer to transmit data. For example, telephone or cable lines. Computer information is stored digitally, whereas information transmitted over telephone lines is transmitted in the form of analog waves. A modem converts between these two forms.
OEM	Abbreviation for Original Equipment Manufacturers. OEMs buy products in bulk and customize them for a particular application.
ORBCOMM	ORBCOMM uses Low-Earth-Orbit (LEO) satellites to provide cost-effective tracking, monitoring and messaging capabilities to and from anywhere in the world.
PCB	A thin plate on which chips and other electronic components are placed.
SC	Subscriber Communicator. Modems that are configured to the ORBCOMM satellites to send and receive messages.
SMTP	Simple Mail Transfer Protocol, a protocol for sending e-mail messages between servers. Most e-mail systems that send mail over the Internet use SMTP to send messages from one server to another; the messages can then be retrieved with an e-mail client using either POP or IMAP. In addition, SMTP is generally used to send messages from a mail client to a mail server.
VHF	Abbreviation for Very High Frequency. The radio frequency in the range 30 MHz - 300 MHz.

Introduction

Overview about ORBCOMM

ORBCOMM is a wireless telecommunications company providing narrow band two-way digital messaging, data communications, and geo-positioning services on a global basis. ORBCOMM operates a network consisting of 30 Low Earth Orbit (LEO) satellites and terrestrial gateways deployed around the world. Through this network, ORBCOMM delivers information to and from virtually anyplace in the world on a nearly real time basis.

The ORBCOMM system uses LEO satellites to provide cost-effective tracking, monitoring and messaging capabilities to and from anywhere in the world. The system is capable of sending and receiving two-way alphanumeric packets of data. These short, economical messages increase the efficiency of the remote operations by making critical information readily available, often from areas beyond the geographic and economic reach of traditional systems.

How ORBCOMM works

The ORBCOMM system provides global, two-way, data communication services to a wide variety of applications. Subscriber communicators (SCs) pass data messages to and from Gateway Control Centers (GCC) over ORBCOMM satellites and GCCs route messages to users over the internet or dedicated delivery lines.

SCs are a highly versatile communication device which communicates directly with satellites using ORBCOMM's packet-switched protocol, and supports full transmission acknowledgement. The satellites provide SCs with system information and serve as the communication link between SCs and the ORBCOMM terrestrial network.

Messaging traffic flows between the satellites and a GCC through tracking stations called Gateway Earth Stations (GESs) that connect with satellites as they pass overhead. The internet is commonly used for final transmission to the user.

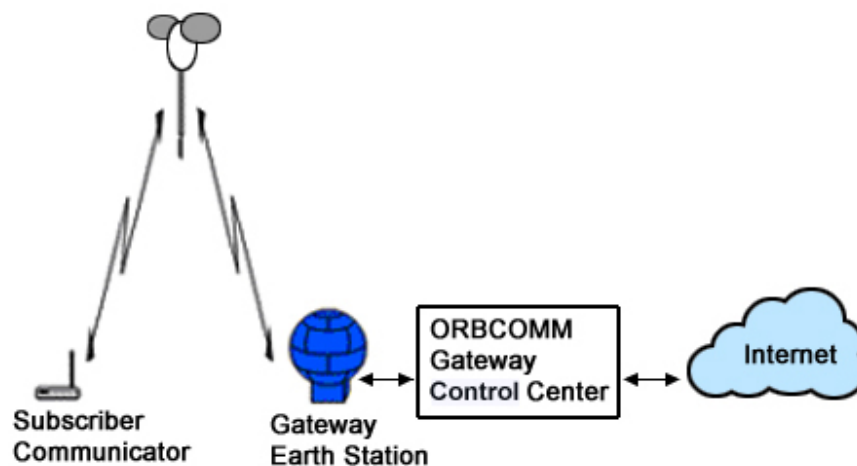

Overview about m100

The m100 is the next generation satellite data communication transceiver that transmits and receives data by using the ORBCOMM. The m100 is a low cost ORBCOMM modem based on the Analog Devices Blackfin DSP and analog ASIC. The m100 OEM transceiver plays a vital role in transmitting and receiving the data for the customers involved in satellite-based tracking and industrial remote communication.

The m100 operates over the ORBCOMM low orbit satellite network, providing unlimited global coverage with no blockage. It can significantly improve asset utilization by allowing clients to monitor, track and manage their fixed and mobile assets around the world. The three chip m100 OEM transceiver includes the Analog Devices Blackfin® DSP family, MobiApps' Analog ASIC, and a GPS RF down converter, creating a fully integrated satellite tracking device.

The m100 is a versatile product and users can quickly implement the solutions that are optimized for their tracking and monitoring applications. The target market of m100 is OEMs and VARS developing fixed site or mobile tracking / monitoring applications.

General Representation

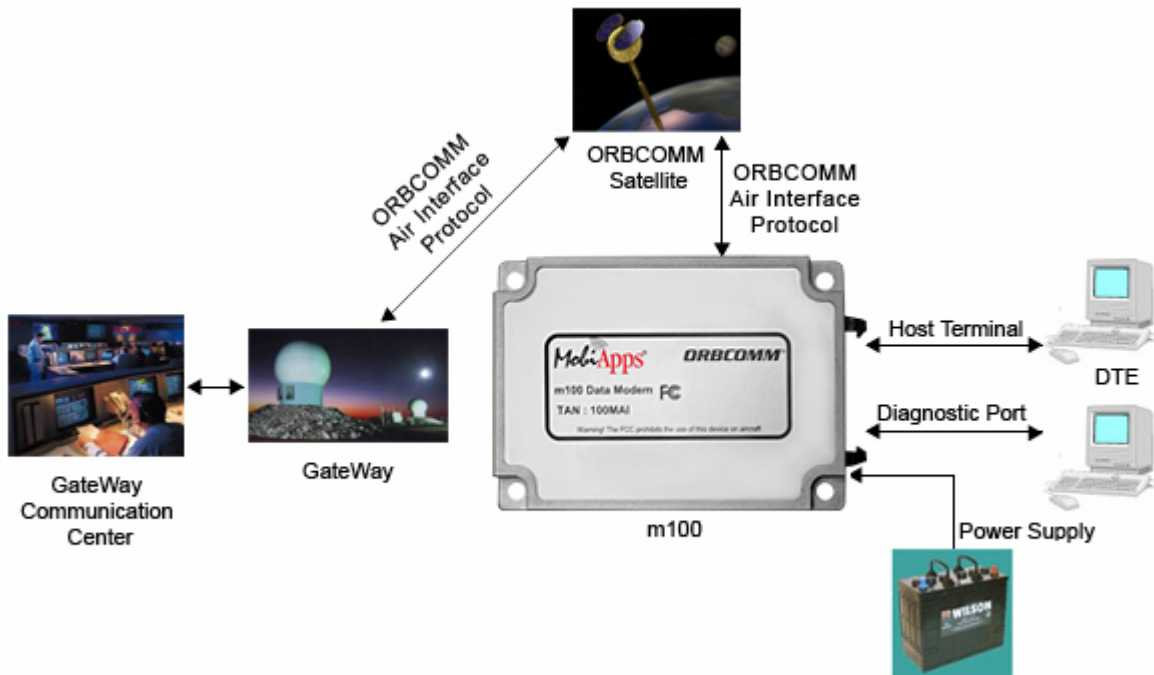

Section – 1: m100

This section introduces you to the Hardware Integration, Software Interface and the Operation of m100. Explore the following chapters in this section:

- [Chapter 1: Hardware Integration](#)
- [Chapter 2: Software Interface](#)
- [Chapter 3: Operation](#)

Chapter 1: Hardware Integration

Chapter Summary

This chapter provides the overview of hardware integration of m100 satellite data transceiver. The chapter also lists the specifications and interfaces required. The chapter covers the following topics:

- [Overview](#)
- [m100 Block Diagram](#)
- [I/O Pin Interface Specification](#)
- [Interface Connector](#)
- [Mounting Details](#)
- [General Description of m100](#)
- [Power Interface](#)
- [Antenna Interface](#)

Overview

The m100 is a small and smart modem which provides geo-positional data through message transmission and reception via ORBCOMM satellite communication system. The customers use m100 to host their application. The hardware integration covers the user interface details of m100 ORBCOMM SC (subscriber communicator).

The hardware integration of m100 comprises of the following units:

1. 40 pin host connector
2. Power supply
3. Diagnostic port
4. Host ports
5. Processor
6. RTC
7. VHF connector
8. GPS connector
9. I/O controller

m100 Block Diagram

The block diagram below gives the high level view of m100 with all the functional entities.

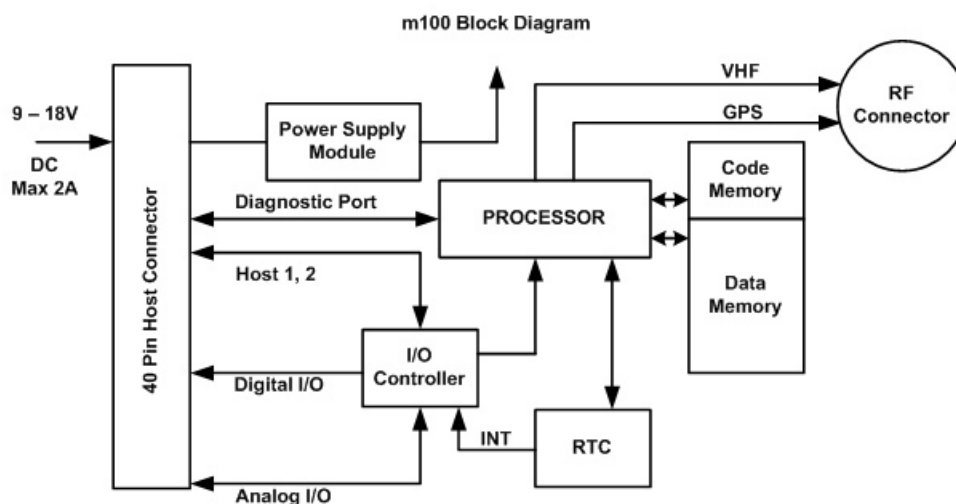

Connector function and location details:

The application connects via the 40 pin **Samtec** connector. The connector functions are listed below:

Diagnostic port:

- RS-232 without hardware flow control (TX, RX, DTR pins). Fixed baud rate at 115200bps.
- DTR should be able to interrupt / wakeup the system when it is in the sleep mode.

Host Port1:

- User-configurable 3.3V with only DTR flow control (TX, RX, DTR, GND pins).
- User-configurable baud rates: 1200, 4800, 9600 and (optional) higher data rates.

Digital I/O (3.3 V levels)

1. 10 user-configurable I/O's.
Listed below are three digital I/O indicators among 10 user-configurable I/O's:
 - ORBCOMM tracking
 - GPS fixing
 - Sleep state indicator
2. 4 input configurable as interrupt.
3. Analog inputs: 4 + 1 (high speed sampling rate), 10-bit (voltage range - 0 to 3.3 V)

GPS and VHF connector

1. GPS connector: Part No. MMCX-J-P-H-ST-EM1, MMCX socket.
2. VHF connector: Part No. MMCX-P-P-H-ST-EM1, MMCX plug

Please refer the figures given below for understanding m100.

40 pin connector view

The m100 40 pin connector is shown in the figure below:

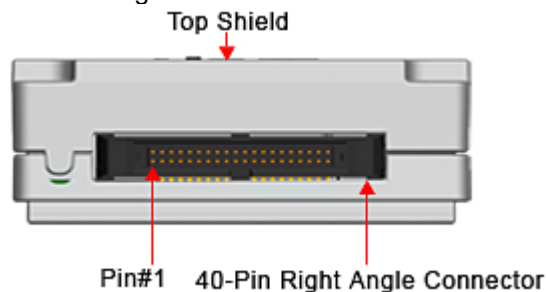

VHF and GPS connector view

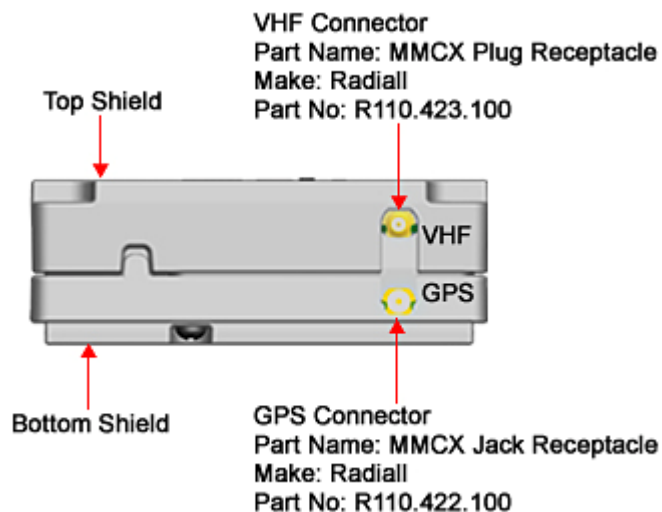

I/O Pin Interface Specification

1. Interrupt and bidirectional GPIO inputs

- Input signal level for low: Minimum: GND, Maximum: 0.6
- Input signal level for high: Minimum: 2.4V, Maximum: 3.3V

2. Bidirectional GPIO outputs

- Output signal for low: 0.4V Max
- Output signal for high: 2.7V Min
- Sink current: 10mA Max
- Source current: 10mA Max
- No short circuit protection on I/O

3. Analog inputs

- Input signal level: 0V Min - 3.0V Max

Interface Connector

The m100's primary interface is through its 40-pin connector. The mapping of these pins is defined in the table below:

Pin	Pin Description	Pin	Pin Description
1	3.3 V trickle power for RTC and MCU during sleep	2	Analog signal ground
3	Not used	4	Digital 2 (interruptible)
5	Digital 3 (interruptible)	6	Digital 4 (interruptible)
7	Digital 5 (interruptible)	8	Digital 6
9	Digital 7	10	Digital 8
11	Digital 9 / CAN Bus TX	12	Digital 10 / CAN Bus RX
13	Digital 11 / I2C SDA	14	Digital 12 / I ² C SCLK
15	Digital 13	16	Digital 14 / MCU TX
17	Analog 0 (high speed)	18	Digital 15 / MCU RX
19	Analog 1	20	Analog 2
21	Analog 3	22	Analog 4
23	Diagnostic TX	24	Diagnostic RX
25	Host1 RX	26	Host1 TX
27	Host1 DSR	28	Digital 1 (interruptible) / Host1 DTR
29	Host1 CTS	30	Host1 RTS
31	Host2 TX	32	Host1 CD
33	Digital 0 (interruptible) / Host2 DTR	34	Host2 RX
35	9 to 18 volt supply	36	System ground
37	9 to 18 volt supply	38	System ground
39	9 to 18 volt supply	40	System ground

Mounting Details

Mounting m100 on the DK100:

Insert the 40 pin mating connector in the 40 pin user interface connector with proper polarity. Use the ejectors to remove the 40 pin mating connectors.

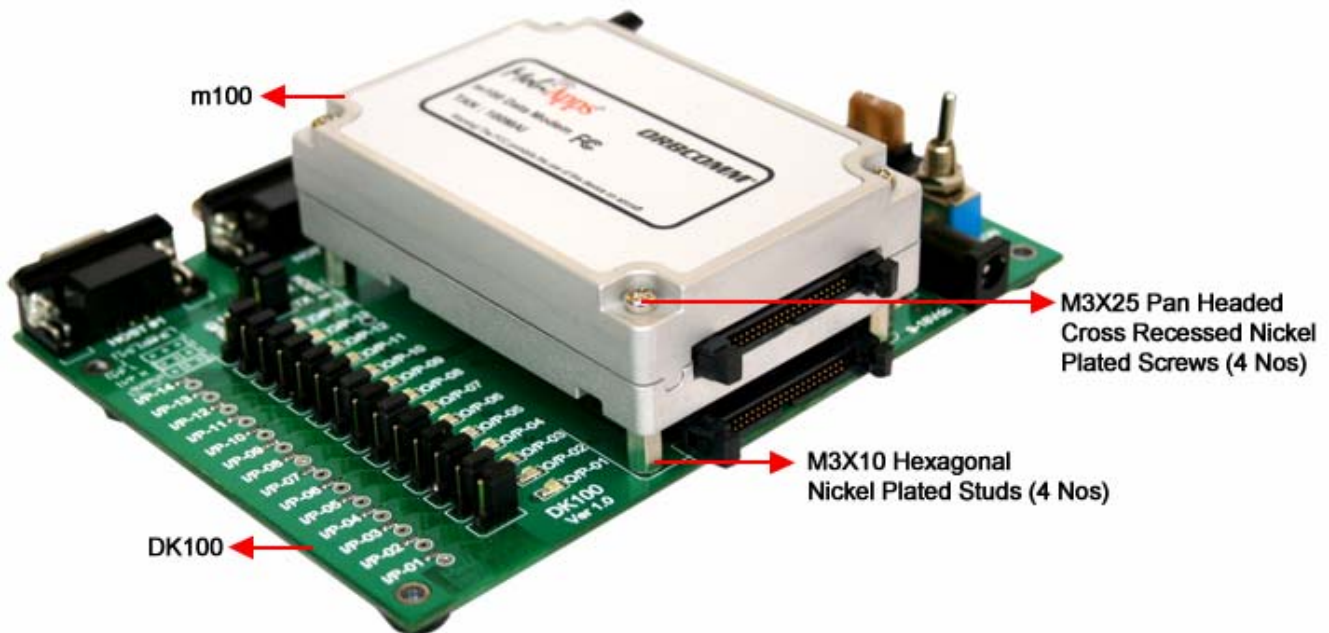

The m100 is mounted on the DK100 as shown in the figure above. Some precautions have to be taken when m100 is mounted on the kit.



1. **Handle the box with care to avoid the scratches.**
2. **Do not access the 40 pin connector without ESD protection.**

Mechanical dimensions for mounting m100

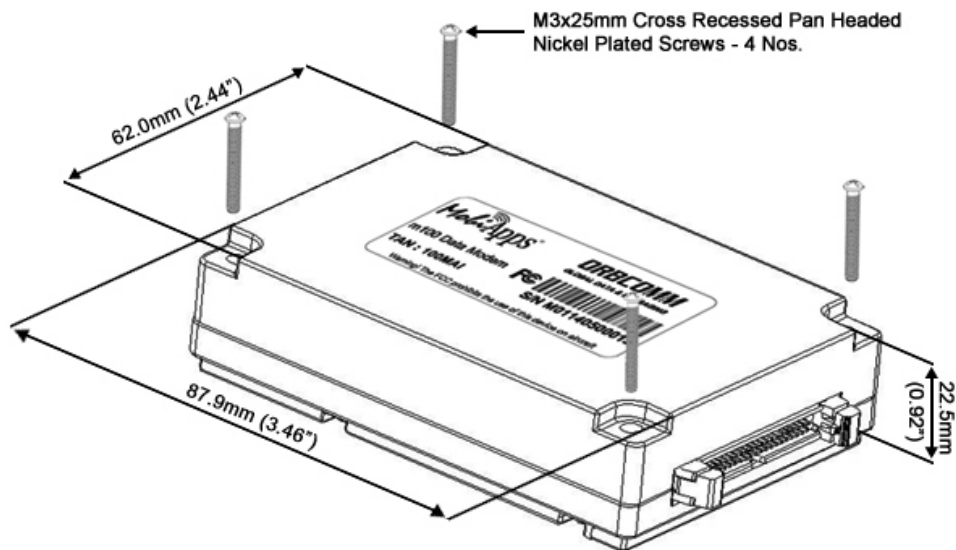

Mating part to 40 pin host connector



Integration of m100 with the Application is shown in the figure below.

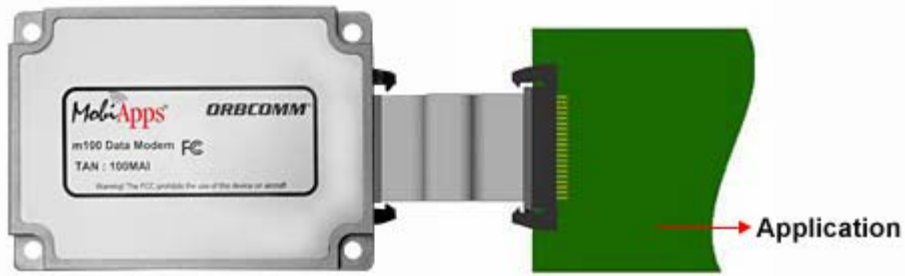

General Description of m100

Physical dimensions of m100

The m100 outline dimension is shown below:



The side view dimension is shown below:



Power Interface

Power is interfaced through 40 pin FRC user interface connector. The required specifications are as follows:

- Main supply: 9V to 18VDC, 2Amp (12V battery system)
- Sleep backup supply: 3.3VDC, 15mAmp, Ripple <30mV (optional for stand alone user)

Antenna Interface

GPS antenna: Use MMCX socket. VHF antenna: Use MMCX plug.

Chapter: 2 Software Interface

Chapter Summary

Configure m100 satellite data transceiver using HyperTerminal on DTE. Understand the ports and procedures to upgrade the firmware. This chapter covers the following topics:

- [System Environment](#)
- [Diagnostic Port](#)
- [Commands and Responses](#)
- [Host – 1 Serial Port](#)
- [Host – 2 Serial Port](#)
- [Firmware Upgrade Procedures](#)
- [Developing Applications](#)

System Environment

HyperTerminal is an application running on the Data Terminal Equipment. Connect the corresponding serial port to the port of the modem for the data transfer. The user has to install and configure the HyperTerminal in the PC.

Given below is the process to start the HyperTerminal and know more about the properties:

Step1: Start the HyperTerminal in the DTE by clicking **Start -> Accessories -> Communications -> HyperTerminal**

Step 2: Click the **HyperTerminal** to get the location specific UI.

Step 3: On the HyperTerminal UI, view the m100 **Satellite Modem Properties**.

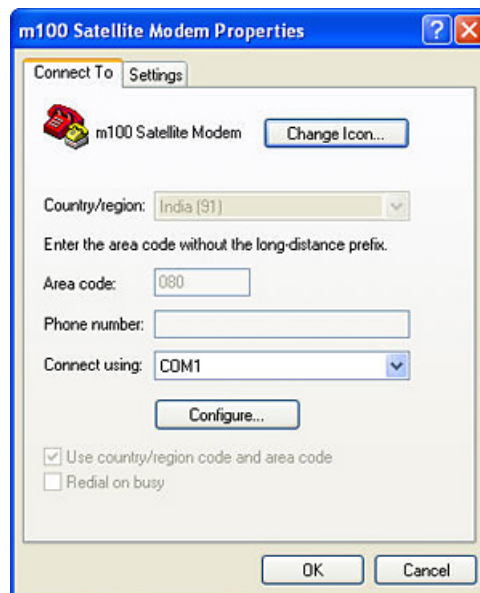

Step 4: Select the **Disconnect** icon from the toolbar, and click the **Configure** button to view the **Com** properties. The **Com** properties are displayed in the figure below.

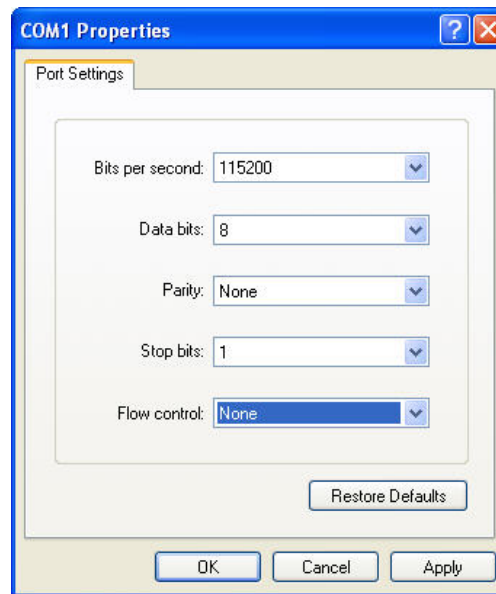

Step 5: To capture text or data on a file and send the text file. Click the **Transfer** icon from the toolbar, select capture text or data. Select the path and start the transfer of text from serial port to the modem.

Diagnostic Port

Diagnostic port is a port of the modem. The baud rate of this port is fixed (115200 bps). The user views the debug statements on the HyperTerminal which is connected to the diagnostic port of the modem.

Debug statement

Steps to view the debug statements from diagnostic port of m100 on the HyperTerminal:

1. Connect one of the serial ports of the DTE to the diagnostic port of satellite modem.
2. Run the HyperTerminal application on the DTE with the serial port settings.
3. Supply power to the satellite modem unit.
4. The debug statements are displayed on the HyperTerminal of the DTE.

Commands and Responses

Operate the modem using the interface commands and responses. For example: Use the option 4 in the UI to queue the SCO messages.

Host -1 Serial Port

The Host 1 serial port satisfies the ORBCOMM Serial Interface protocol. This port supports the hardware flow control according to RS 232 standards. The baud rate is configurable - 300, 600,1200,2400,4800 and 9600.

ORBCOMM Serial Interface protocol

ORBCOMM Serial Interface protocol enables any application running on the Data Terminal Equipment (DTE) to communicate with the modem. For further details refer to *ORBCOMM Serial Interface* document.

Host - 2 Serial Port

Host 2 serial port is an additional port with the same properties like the host 1 except that it doesn't support the flow control. DTR wakes up the DSP from hibernation (if DSP goes to hibernation) when the DTR is active. The baud rate is should be in the range of 2400 - 9600.

Firmware Upgrade Procedures

Given below are the steps for the firmware upgrade procedures:

1. Keep the ldr (loader) to be loaded into DSP and the application PCApp15_woJump.exe in one folder.
2. Connect one of the serial ports of your PC to the diagnostic port of satellite modem.
3. Turn Off the power of the modem.

4. Open the application PApp15_woJump.exe.
5. Enter the COM port number of PC. (For example 1).
6. Now switch **On** the power for the modem.
7. Type 4 and press **Enter**.
8. Paste the name of the Idr to be burned into the DSP.
9. Press **Enter**.
10. Wait till you see the prompt - **Press any key to continue**. Click **Enter**.
11. Enter 0 and then again click **Enter**.
12. In order to run, recycle the power of the modem.

Developing Applications

The m100 SDK consists of a set of API functions that control the m100 software and hardware. The user familiar with the C programming language should be able to quickly implement custom applications using the APIs provided in the reference document. With the tools provided with the SDK, these applications can be embedded into m100 to take full advantage of the power and functionality of m100. For further details refer the m100 SDK API document.

Chapter 3: Operation

Chapter Summary

This chapter takes you through the system architecture and operation requirements of m100 satellite data transceiver. The chapter covers the following topics:

- [System Architecture](#)
- [Device Configuration](#)
- [Host Vs Diagnostic Port](#)
- [Sending and Receiving Messages](#)
- [Low Power Modes](#)
- [Satellite Acquisition](#)

System Architecture

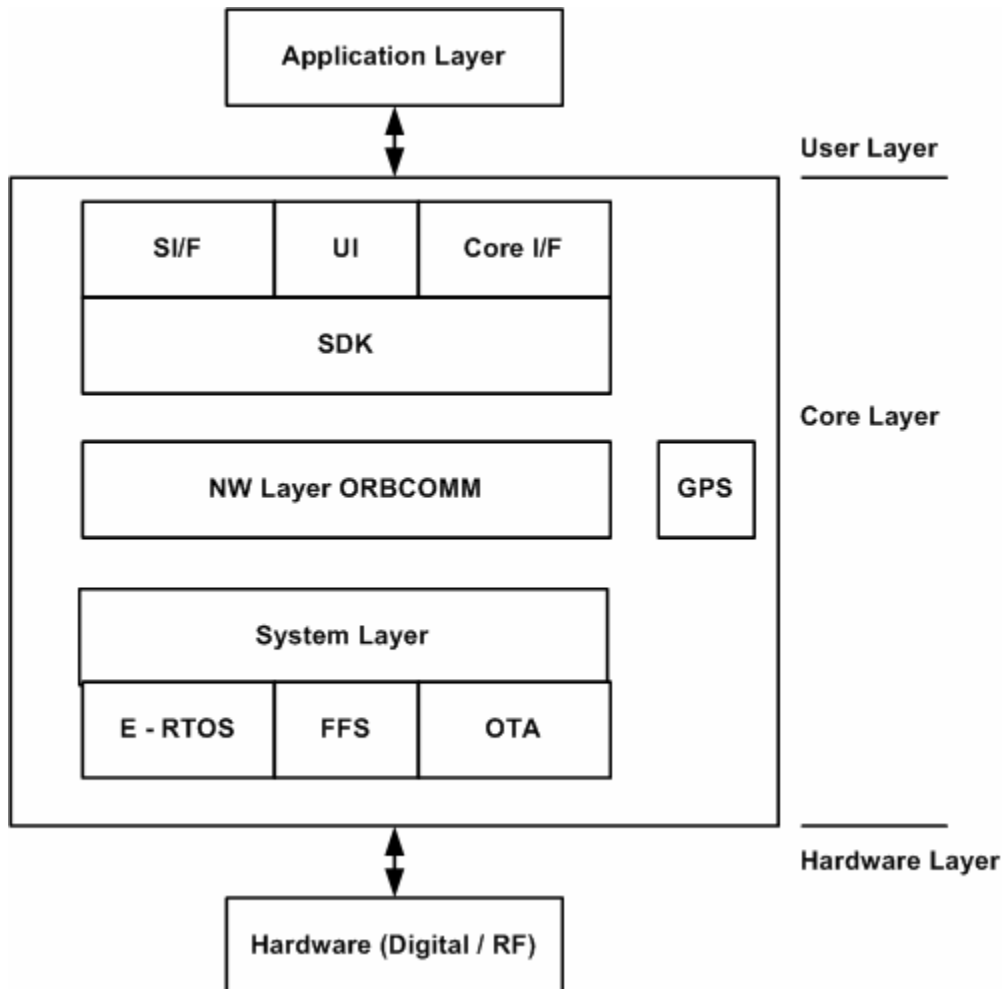

Device Configuration

The device configuration covers the factory reset, system reset and ORBCOMM network services.

Factory reset: The process of setting (SC) subscriber communicator parameters to factory default is known as factory reset. The factory reset takes place by setting ORBCOMM serial interface parameter from 48 to 0.

System reset: The process of recycling power to the modem is called system reset. The ORBCOMM network services are discussed later in sending and receiving messages.

Host Vs Diagnostic Port

Host port and Diagnostic port have different properties and functionalities as listed below in the table:

Host port	Diagnostic port
The baud rate can be configured and varied.	The baud rate is fixed.
ORBCOMM Serial Interface protocol is satisfied.	ORBCOMM Serial Interface protocol is not satisfied.
Flow control can be supported.	Flow control is not supported.

Sending and Receiving Message

The m100 can receive and send the text data through ORBCOMM satellite network. The messages are transferred via packets and ORBCOMM helps in the transfer of the data.

The (SC) subscriber communicator is a wireless VHF/GPS modem that transmits messages from the user to ORBCOMM system with a delivery acknowledgement and receives the intended messages from the system.

Following are the ORBCOMM basic service elements:

- SCO messages
- SCO default messages
- SCT messages
- SCO report
- SCO default report
- SCT user command
- SCO Globalgram
- SCT Globalgram
- SCO message enquiry
- Polling by ORBCOMM system
- System command
- SCT broadcast message

Low Power Modes

The purpose of modem running in n/16 mode is to reduce the power consumption when the modem is not transmitting the data. This is only applicable when the modem is receiving the signal but not transmitting. When the modem is in low power mode, it's **ON** for 'n' frames out of 16 frames. (1 frame is equivalent to 1 second).

Modem enters sleep mode for the remaining frames. During sleep mode, the processor's core clock shuts down but the system clock keeps running. Currently 2/16, 3/16 and 6/16 is supported. Low power mode helps in the power saving and so the battery can run for more time.

Satellite Acquisition

When the (SC) subscriber communicator is switched on, the SC starts searching for the ORBCOMM signal. It does so by searching for a valid signal at possible ORBCOMM frequencies. The RF is tuned to each frequency. For each frequency, 512 samples are taken and processed to estimate the signal to noise ratio. The channel that provides the best ratio is used for data reception.

The down link to the SCs is transmitted at 4800 bits per second (bps). Frequency corresponding to a particular down link channel = $137.0000 + 0.0025 * n$ MHz. where $50 < n < 349$.

Section 2: DK100

This section introduces you to the MobiApps DK100 Evaluation Kit, its features, interfaces and connection details of the evaluation kit to Customer Target Circuitry. This section has the following chapters:

- [Chapter 1: Introduction to DK100](#)
- [Chapter 2: DK100 Hardware Interface](#)
- [Chapter 3: Setting up DK100 Evaluation Kit](#)

Chapter 1: Introduction to DK100

Chapter Summary

This chapter gives you the overview of DK100 Evaluation Kit, explains its PCB layout and the on-board peripherals. This chapter covers the following topics:

- [Overview](#)
- [Key features](#)
- [On-board Peripherals](#)
- [General Precautions](#)
- [DK100 PCB](#)
- [Block Diagram](#)

Overview

The DK100 Evaluation Kit is a complete kit that houses DK100 hardware interface unit, MobiApps' m100 SC and OEM's target circuitry. The Evaluation Kit combines the target circuitry, analog input, digital input/output, access host ports and diagnostic port to develop a solution.

Given below is the complete kit.

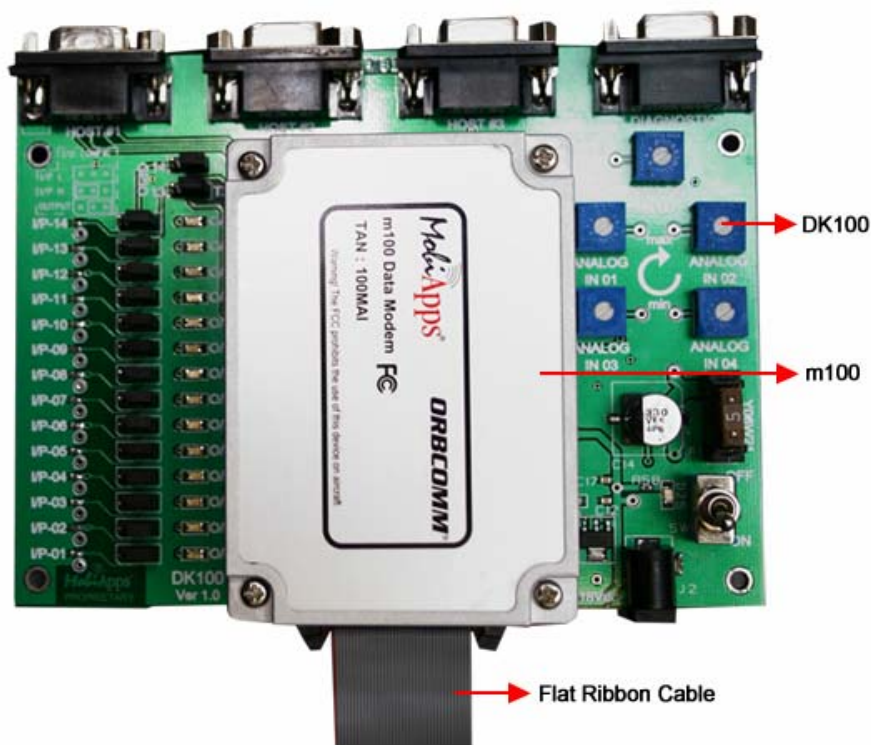

Key Features

The DK100 Evaluation Kit has all features that are required to evaluate m100 SC. The key features of DK100 Evaluation Kit are mentioned below:

- 2 Host ports, 1 Diagnostic port and 1 Optional Host port
- Supports RS 232 Application communication
- LED Array (14 Digital Output LED's and 1 Power LED)
- 16 Digital I/O, 5 Analog Inputs

On-board Peripherals

1. 4 Serial ports (3 Host ports and 1 Diagnostic port)
2. + 9V to + 18V DC power supply jack (J2)
3. Power On/Off switch (SW1)
4. 3.3V Regulator (U3)
5. Fuse (F1)
6. RS232 Drivers
7. 5 Analog Potentiometers
8. 14 Digital I/O Jumpers
9. 14 Digital Output LED's
10. 2 Digital GPIO Jumpers
11. 40 Pin interface connector
12. Over voltage protection circuit

General Precautions

	Never plug the power cord in the outlet before connecting the power cable into the DK100 Evaluation Kit.
	Never try to repair the DK100 Evaluation Kit when it does not work. Consult the customer service agent if the problem persists.
	Never touch the DK100 Evaluation Kit with your wet hands or wipe the metal parts of the battery with a wet cloth. Do not soak the battery in water or touch with wet hands.
	Never hook up a power source outside of the DK100 Evaluation Kit specified limit.

DK100 PCB

DK100 Evaluation Kit – PCB with M3X10 hexagonal studs (4 Nos.) fixed on the board to mount the m100 SC is shown in the figure below:

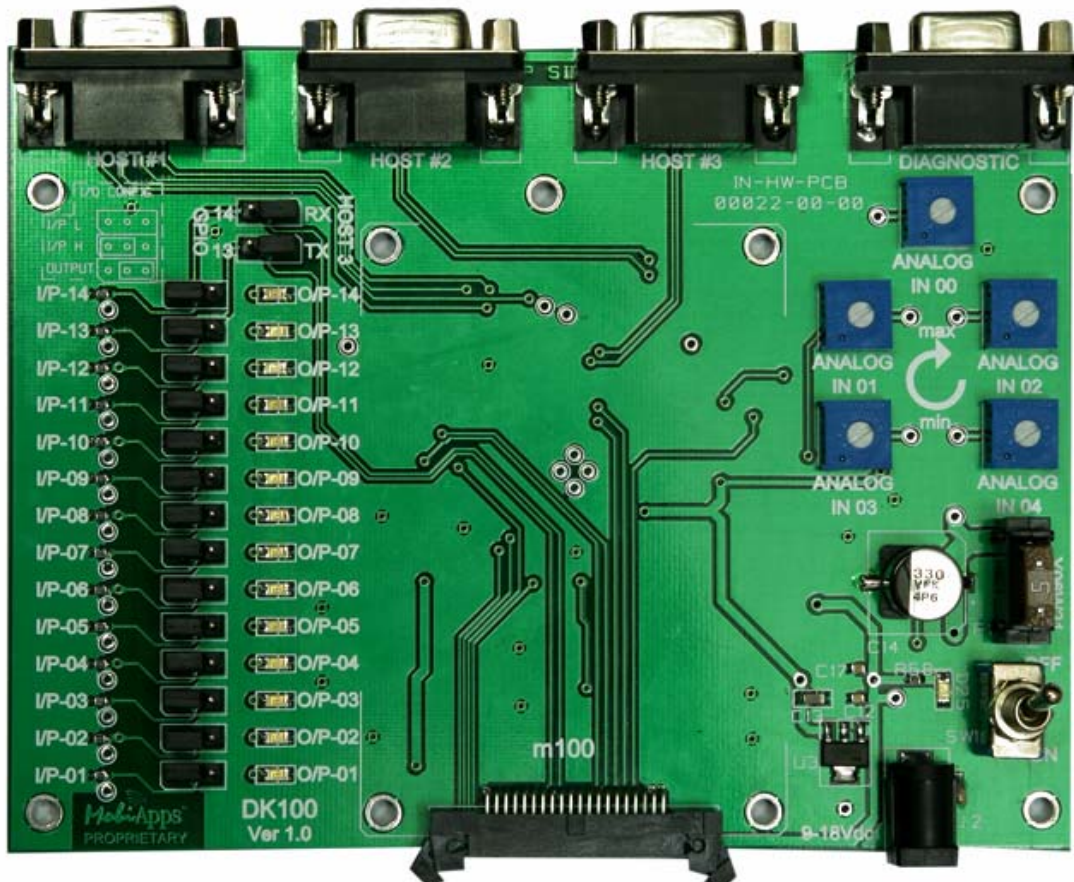

DK100 Evaluation Kit - PCB

Block Diagram

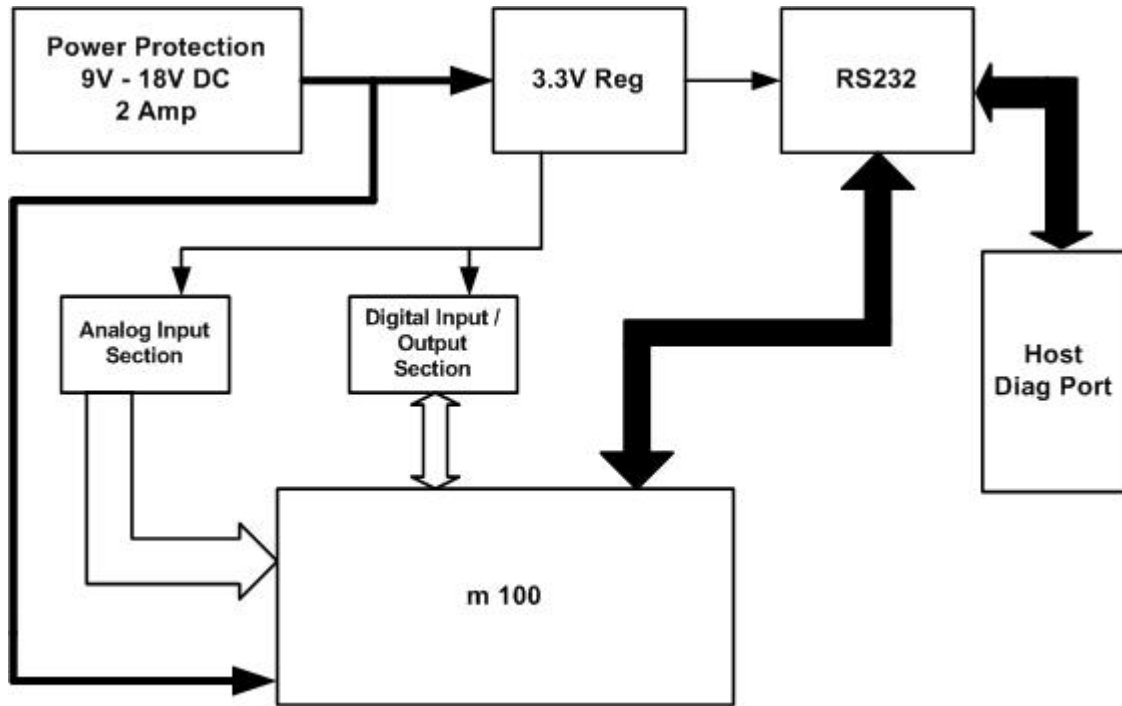

Power Supply

The DK100 hardware interface is provided with 110V to 240V input AC adaptor for power supply. The input power range for DK100 is + 9V to 18V DC, 3A and is turned ON/OFF by switch (SW1). A LED (D25) indicates the power status.

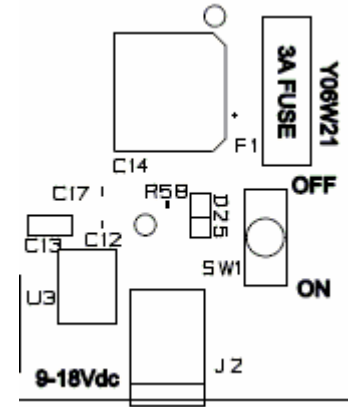

Analog Input

The DK100 hardware interface unit has 5 analog channels (A0, A1, A2, A3, and A4). The preset value for each analog channel is varied from 0 through 3.0V DC by turning the Potentiometer (Analog IN 00, Analog IN 01, Analog IN 02, Analog IN 03, and Analog IN 04) in clock-wise or anti-clock direction.

Digital Input / Output

The DK100 hardware interface unit has 10 digital input and output channels and 4 interruptible inputs. These I/Os can be configured to work on DK100 with m100 SC or tested as per the requirements of customer target circuitry. Each digital status can be tested independently. The block I/O CONFIG as shown in the diagram explains about the input low, input high and the output by selecting and short linking the jumper pins or by keeping them open.

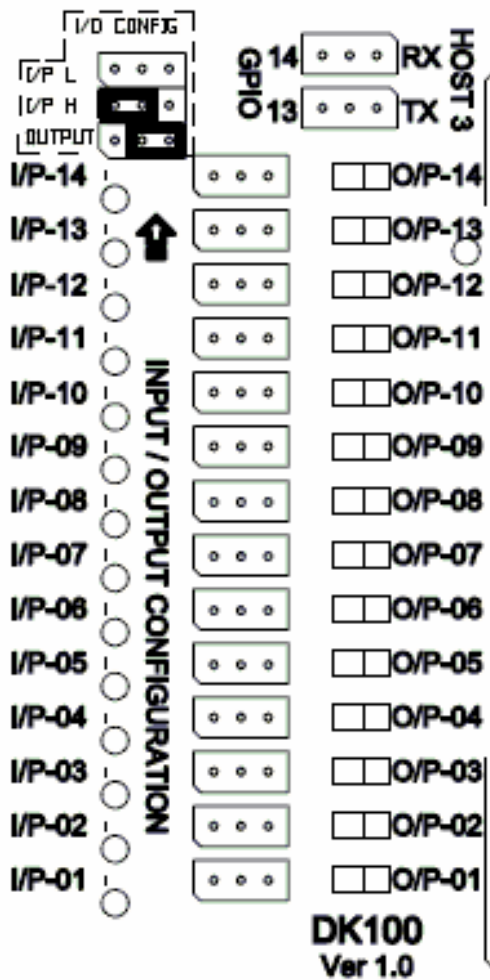

I/P L: Keep the jumpers open (don't short link them) to get the digital input low.

I/P H: Short link the header pins (pin 1 & 2) of the jumpers as shown in the I/O CONFIG block to get the digital input high.

OUTPUT: Short link the next two pins (pin 2 & 3) of the jumpers as shown in the I/O CONFIG block to get digital output.

Testing:

1. Test the digital input as low by removing or by keeping the corresponding I/O jumpers open as shown in the diagram.
2. Test the digital input as high by short linking the jumpers as explained above.
3. Test digital output by connecting / shorting the jumpers. Check the status of digital output on corresponding LED.

Output LED Status:

- a. If the corresponding LED glows, the digital output status is high.
- b. If the corresponding LED doesn't glow, the digital output status is low.

GPIO

GPIO (General Purpose Input/Output) allows configuring HOST 3 port. Configure the HOST 3 port if required by following the instructions given below:

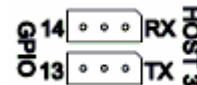

- Short link the jumper pins 1 & 2 (left side next to the no's 13 and 14 as shown in the diagram) or as explained in the Digital Input / Output section to use GPIO as I/O's.
- Short link the jumper pins 2 & 3 (right side next to RX and TX as shown in the diagram) or as explained in the Digital Input / Output section (HOST 3) to upgrade MCU code through HOST3. This requires the power on condition.

Potentiometer

There are 5 Analog potentiometers present on DK100 evaluation kit. Potentiometer has user adjustable resistance. The user can adjust the preset value of each analog channel that varies from 0 through 3.0V DC. Turn the Potentiometer (Analog IN 00, Analog IN 01, Analog IN 02, Analog IN 03, and Analog IN 04) in clock-wise or anti-clock direction as per the requirement. The diagram shown explains how to rotate the potentiometer in clock-wise direction to get the maximum volts. Rotate the potentiometer in the anti clock-wise direction to get the minimum volts or to set it for 0 volts.

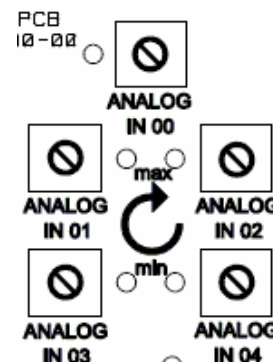

m100 Interface

m100 SC is connected to DK100 through the 40pin connector using FRC (flat ribbon cable). The 40 pin details are listed in the table below:

Pin	Pin Description	Pin	Pin Description
1	3.3 V trickle power for RTC and MCU during sleep	2	Analog signal ground
3	Not used	4	Digital 2 (interruptible)
5	Digital 3 (interruptible)	6	Digital 4 (interruptible)
7	Digital 5 (interruptible)	8	Digital 6
9	Digital 7	10	Digital 8
11	Digital 9 / CAN Bus TX	12	Digital 10 / CAN Bus RX
13	Digital 11 / I2C SDA	14	Digital 12 / I ² C SCLK
15	Digital 13	16	Digital 14 / MCU TX
17	Analog 0 (high speed)	18	Digital 15 / MCU RX
19	Analog 1	20	Analog 2
21	Analog 3	22	Analog 4
23	Diagnostic TX	24	Diagnostic RX
25	Host1 RX	26	Host1 TX
27	Host1 DSR	28	Digital 1 (interruptible) / Host1 DTR
29	Host1 CTS	30	Host1 RTS
31	Host2 TX	32	Host1 CD
33	Digital 0 (interruptible) / Host2 DTR	34	Host2 RX
35	9 to 18 volt supply	36	System ground
37	9 to 18 volt supply	38	System ground
39	9 to 18 volt supply	40	System ground

Serial Ports

The DK100 hardware interface has 4 serial ports (2 HOST ports, 1 Optional HOST port and 1 DIAGNOSTIC port).

1. The Host port 1 has five wires: RX, TX, DTR, CTS, and RTS.
2. The Host port 2 has 4 wires: TX, RX, DTR and ground.
3. The Host port 3 has 3 wires: RX, TX and ground.
4. The Diagnostic port has 3 wires: RX, TX, and ground.

These serial ports are driven by RS232 drivers and are terminated to DB9 female connectors.



Chapter 3: Setting Up DK100 Evaluation Kit

Chapter Summary

Learn the connection details of DK100 Evaluation Kit in this chapter. This chapter covers the following topics:

- [DK100 Evaluation Kit Architecture](#)
- [Connecting the m100 SC to the Hardware Interface Unit](#)
- [Connecting Host Port to Customer Target Circuitry](#)
- [Connecting Diagnostic Port to DTE](#)
- [Powering the DK100 Evaluation Kit](#)

DK100 Evaluation Kit Architecture

DK100 Evaluation Kit is a hardware interface between the customer's target circuitry (through test points on DK100 board) and MobiApps' m100 ORBCOMM SC (for communicating over the ORBCOMM global satellite network). The evaluation kit helps in connecting the target circuitry, digital input/output, access host ports and the diagnostic port.

Connecting the m100 SC to the Hardware Interface Unit

DK100 evaluation kit has M3X10 hexagonal studs (4 Nos.) fixed on the board to mount the m100 SC on DK100 using these studs. Mount m100 SC on these studs and fix with M3X25 pan headed cross recessed nickel plated screws (4 Nos). Connect the m100 SC with DK100 evaluation kit using FRC (Flat Ribbon Cable).

Connecting Host Port to Customer Target Circuitry

Use standard RS 232 cable to connect the Host Port from hardware interface unit to customer target circuitry. Use Host port 1 or 2 to communicate with m100 SC and the On-board test points.

Connecting Diagnostic Port to DTE

Use standard RS 232 male to female cable from DTE to hardware interface unit. Plug the male end of RS 232 serial cable to the Diagnostic port on DK100 hardware interface unit. And the female end of the cable to the available COM port on the DTE.

Powering the DK100 Evaluation Kit

Ensure that the m100 SC is mounted and connected to the DK100 evaluation kit. Configure I/Os as per the requirement. Follow the steps mentioned below to power DK100 evaluation kit:

1. Connect the Diagnostic port to the DTE using RS 232 cable.
2. Connect the Host 1, 2 to the target circuitry.
3. Configure the Digital I/O jumpers as required.
4. Set the Analog inputs as required.
5. Connect the power + 9 to +18V DC to jack J2 on DK100.
6. Power on DK100 using switch SW1
7. Observe the LED D25 is glowing. (LED D25 glows on Power-On)
8. Observe Diagnostic information on the DTE through Diagnostic port.

Troubleshooting

Please check the guidelines listed below before requesting service.

1. No communication between the m100 and satellites

Cause	Remedy
ORBCOMM antenna is not connected	Connect the ORBCOMM antenna
Antenna line - of - sight obstructed	Clear any obstacles or move antenna
Satellite is not in view	Wait until satellite is in view
Communicator's GCC ID does not match local GCC	Check and change to correct GCC

2. No Position Data

Cause	Remedy
GPS antenna not connected	Connect the GPS antenna
Antenna line-of-sight obstructed	Install the GPS antenna horizontally on a flat surface, free from obstruction

3. Power Supply

Power Supply should be in the range of 9V to 18V DC, 2 Amp (pulse rate)

Cause	Remedy
Transmission performance is very poor	Check whether the voltage is less than 9V
Internal components are getting damaged	Check whether the voltage is more than 18V continuously.

Application Interface

- 40-pin 1.27mm pitch male interface header
- Three Serial Ports:
- ORBCOMM Serial, 3.3V, 7-wire
- Application Programmable, 3.3V, 3-wire
- Diagnostic, RS232, 2-wire
- CAN bus: Optional, CAN 2.0B (3.3V)
- Digital I/O: 14 digital or 12 with CAN bus option, all configurable as input or output
- Analog Inputs: Four 10-bit (3.3 V levels)
- Fast Analog Input: Optional, 12-bit, 20 KSPS
- Wake Triggers: Scheduled using onboard RTC; activation of serial port DTR; four digital inputs

Satellite Communications

- MMCX Pin Plug 50 O Connector
- Minimum Detectable Signal: -120 dBm (typical)
- Transmit Power: 5 Watts Nominal
- TX: 148-150.05 MHz; Rx: 137-138 MHz

Power Specifications

- Input voltage required is in the range of +9 to +18V DC SAEJ1455 compliant.
- Maximum current required is less than 2.0 A at +12V when maximum power is transmitted
- Sleep mode should be less than 50 A @ 12V.
- Reset recovery responds to serial commands within 50 ms of power dip or reset.
- Maximum current drawn in ORBCOMM Rx for all frames in the active mode is 65mA @+12V DC
- External input for sleep circuit is 3.3V DC which is terminated to user interface connector.
- GPS: 30mA @ 12 V

Application Programming

- Program / Data Memory (Flash): 6 MB
- SDRAM: 16 MB
- Language: C/C++ on RTOS
- Environment: ADI Visual DSP w/JTAG
- Flash File System

Environment

- Radiated emissions: per EN 300 832.
- Conducted emissions: per EN 300 832
- Radiated and conducted immunity: per EN 300 832 / SAE J1113/21-23
- Electrostatic discharge: per EN 300 832 / SAE J1113/13 for RF connectors
- Operating temperature: -40 degree centigrade to +85 degree centigrade (SAE J1455)
- Relative humidity: 0% to 95% non-condensing (SAE J1455)

Mechanical

- OEM: 88 x 63 x 22 mm (3.5" x 2.4" x 0.9")
- PCB with RF Shielding; 4-hole M2 mounting

GPS

- MMCX Socket Jack 50 O Connector
- Number of Channels: 12
- Cold Start: < 52 seconds TTFF (90%)
- Hot Start < 10 seconds (90%)
- Designed for use with active 3 V antenna
- Horizontal Accuracy: < 11 meters (90%)

Antenna Specifications

- ORBCOMM VHF: male 50 ohms MMCX.
- GPS: Female 50 ohms MMCX

Standard Pin Diagram

The pin diagram is for DB25 and DB9

Looking Into the DTE Device Connector

